



CARM Customs Declaration and Excise Documents Processing system (CDEPS)

Business Process Specifications for EXPORT System

Section II: Processes of EXPORT System

[CDEPS_EXPORT_BPS]

Issue Date: 25/10/2018

Author: Consortium

Version: 4,10

Contract No.:02-045809/11-0092

Restricted – In Confidence

CARM Customs Declaration and Excise Documents Processing system (CDEPS)	REF: CDEPS_EXPORT_BPS
Business Process Specifications for EXPORT System	VER:410

1. Process Category: Export Control System

1.1. Process Group: Exit Summary Declaration processing at Lodgement

1.1.1.BP0156. Process Exit Summary Declaration @ Office of Lodgement

Business Process Description

The following table provides general information about the 'BP0156. Process Exit Summary Declaration @ Office of Lodgement' process. The Business Process Diagram and the description of various business process elements are specified in the following paragraphs.

Description	A master process that processes the Exit Summary Declaration at the Office of Lodgement
Precondition(s)	None
Trigger	The process is triggered either by the Exit Summary Declaration received electronically or by the Exit Summary Declaration captured manually by the Customs Officer or from a previously registered document.
Postcondition(s)	None

Business Process Diagram

The Business Process Diagram of 'BP0156. Process Exit Summary Declaration @ Office of Lodgement' is shown below in BPMN notation. The definition of a process that might be used as sub-process by the 'BP0156. Process Exit Summary Declaration @ Office of Lodgement' can be found in this document. Finally, Annex A of CDEPS-BPS-EXPORT provides some explanatory information about the used notation.

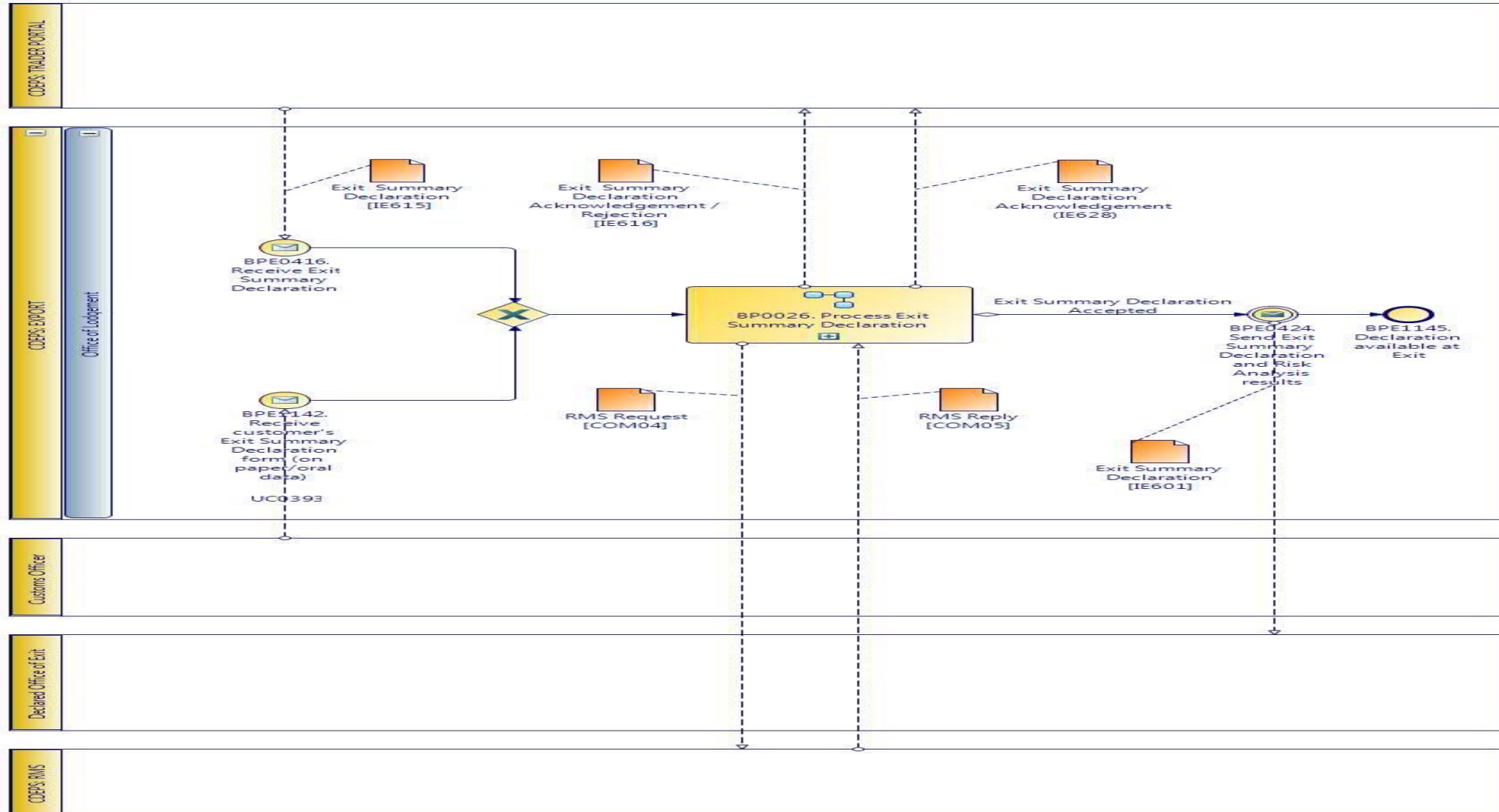

CARM Customs Declaration and Excise Documents Processing system (CDEPS)	REF: CDEPS_EXPORT_BPS
Business Process Specifications for EXPORT System	VER:410

1.1.1.1 Event(s)

The table below defines the 'Event(s)' of the 'BP0156. Process Exit Summary Declaration @ Office of Lodgement' process.

Element Name	Description	Special Type
BPE0416. Receive Exit Summary Declaration	The declaration data is submitted (IE615) to the Office of Lodgement by electronic means.	Start
BPE0424. Send Exit Summary Declaration and Risk Analysis results	The system forwards the Exit summary Declaration (IE601) to the Declared Office of Exit.	Intermediate
BPE1142. Receive customer's Exit Summary Declaration form (on paper/oral data)	The system receives the Exit Summary Declaration form (on paper/oral data) from Customer	Start
BPE1145. Declaration available at Exit	The declaration is available at Exit and the process terminates	End

CARM Customs Declaration and Excise Documents Processing system (CDEPS)	REF: CDEPS_EXPORT_BPS
Business Process Specifications for EXPORT System	VER:410

1.1.2.BP0915. Retrieve Statistics Information

Business Process Description

The following table provides general information about the 'BP0915. Retrieve Statistics Information' process. The Business Process Diagram and the description of various business process elements are specified in the following paragraphs.

Description	Handles the Business Statistics at Export Control System and sending the IE411 to CS/MIS.
Precondition(s)	
Trigger	
Postcondition(s)	

Business Process Diagram

The Business Process Diagram of 'BP0915. Retrieve Statistics Information' is shown below in BPMN notation. The definition of a process that might be used as sub-process by the 'BP0915. Retrieve Statistics Information' can be found in this document. Finally, Annex A of CDEPS-BPS-EXPORT provides some explanatory information about the used notation.

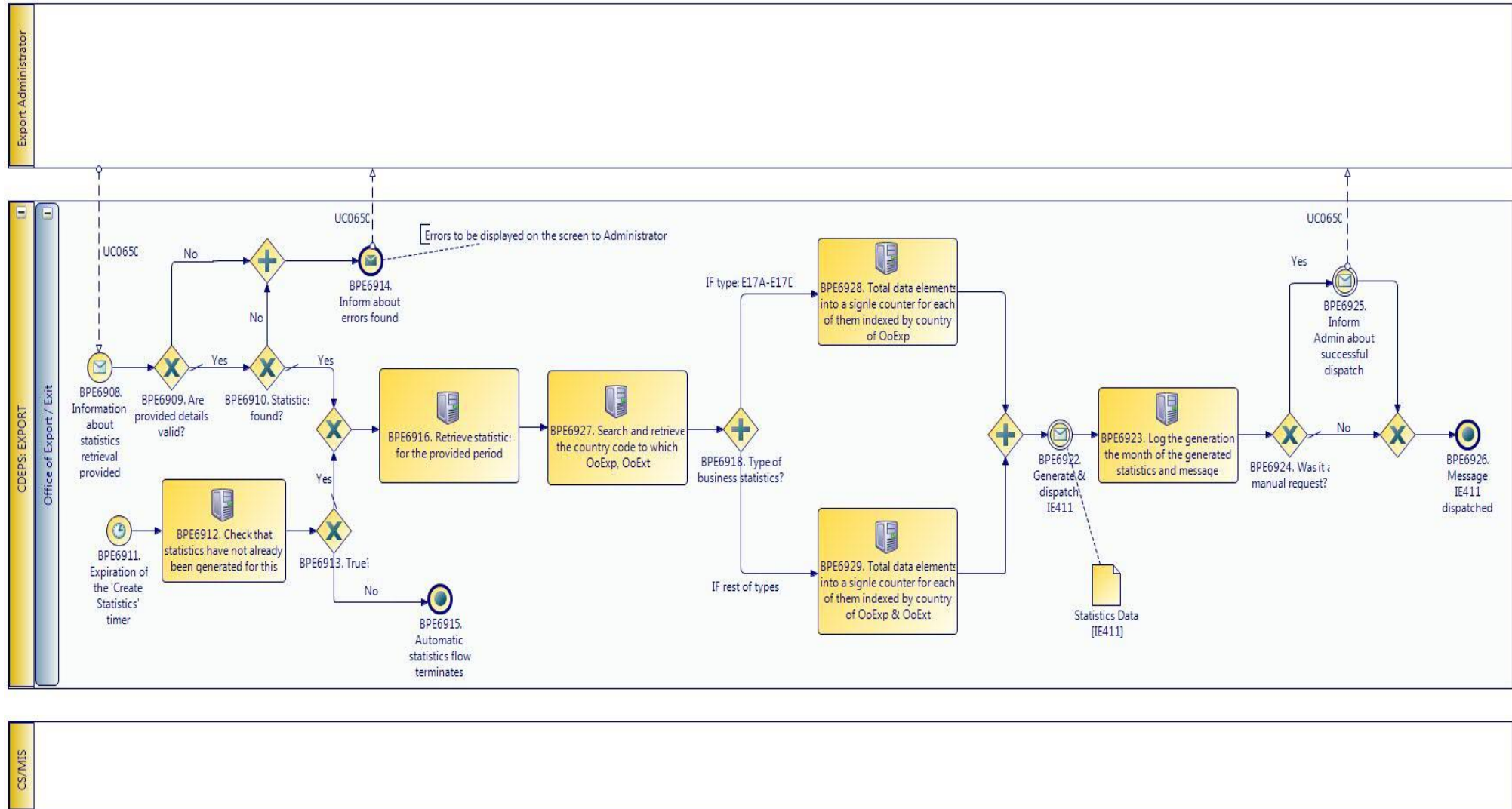

CARM Customs Declaration and Excise Documents Processing system (CDEPS)	REF: CDEPS_EXPORT_BPS
Business Process Specifications for EXPORT System	VER:410

1.1.2.1 Activities

The table below defines the 'Activities' of the 'BP0915. Retrieve Statistics Information' process.

Element Name	Description	Special Type
BPE6912. Check that statistics have not already been generated for this	Check that statistics have not already been generated for this	Service Task
BPE6916. Retrieve statistics for the provided period	Retrieve statistics for the provided period.	Service Task
BPE6923. Log the generation, the month of the generated statistics and message	Log the generation, the month of the generated statistics and message.	Service Task
BPE6927. Search and retrieve the country code to which OoExp, OoExt	Search and retrieve the country code to which OoExp, OoExt.	Service Task
BPE6928. Total data elements into a single counter for each of them indexed by country of OoExp	Total data elements into a single counter for each of them indexed by country of OoExp.	Service Task
BPE6929. Total data elements into a single counter for each of them indexed by country of OoExp & OoExt	Total data elements into a single counter for each of them indexed by country of OoExp & OoExt.	Service Task

CARM Customs Declaration and Excise Documents Processing system (CDEPS)	REF: CDEPS_EXPORT_BPS
Business Process Specifications for EXPORT System	VER:410

1.1.2.2 Event(s)

The table below defines the 'Event(s)' of the 'BP0915. Retrieve Statistics Information' process.

Element Name	Description	Special Type
BPE6908. Information about statistics retrieval provided	Information about statistics retrieval provided by the administrator.	Start
BPE6911. Expiration of the 'Create Statistics' timer	Expiration of the 'Create Statistics' timer.	Start
BPE6914. Inform about errors found	Inform about errors found.	End
BPE6915. Automatic statistics flow terminates	Automatic statistics flow terminates.	End
BPE6922. Generate & dispatch IE411	Generate & dispatch IE411.	Intermediate
BPE6925. Inform Admin about successful dispatch	Inform Admin about successful dispatch.	Intermediate
BPE6926. Message IE411 dispatched	Message IE411 dispatched.	End

1.1.2.3 Gateway(s)

The table below defines the 'Gateway(s)' of the 'BP0915. Retrieve Statistics Information' process.

Element Name	Description	Special Type
BPE6909. Are provided details valid?	Are provided details valid?	Decision
BPE6910. Statistics found?	Statistics found?	Decision
BPE6913. True?	True?	Decision

CARM Customs Declaration and Excise Documents Processing system (CDEPS)	REF: CDEPS_EXPORT_BPS
Business Process Specifications for EXPORT System	VER:410

BPE6918. Type of business statistics?	Type of business statistics?	Decision
BPE6924. Was it a manual request?	Was it a manual request?	Decision

CARM Customs Declaration and Excise Documents Processing system (CDEPS)	REF: CDEPS_EXPORT_BPS
Business Process Specifications for EXPORT System	VER:410

1.1.3.BP0917. Update Statistics Information

Business Process Description

The following table provides general information about the 'BP0917. Update Statistics Information' process. The Business Process Diagram and the description of various business process elements are specified in the following paragraphs.

Description	Handles the updating of Business Statistics at Export Control System.
Precondition(s)	
Trigger	
Postcondition(s)	

Business Process Diagram

The Business Process Diagram of 'BP0917. Update Statistics Information' is shown below in BPMN notation. The definition of a process that might be used as sub-process by the 'BP0917. Update Statistics Information' can be found in this document. Finally, Annex A of CDEPS-BPS-EXPORT provides some explanatory information about the used notation.

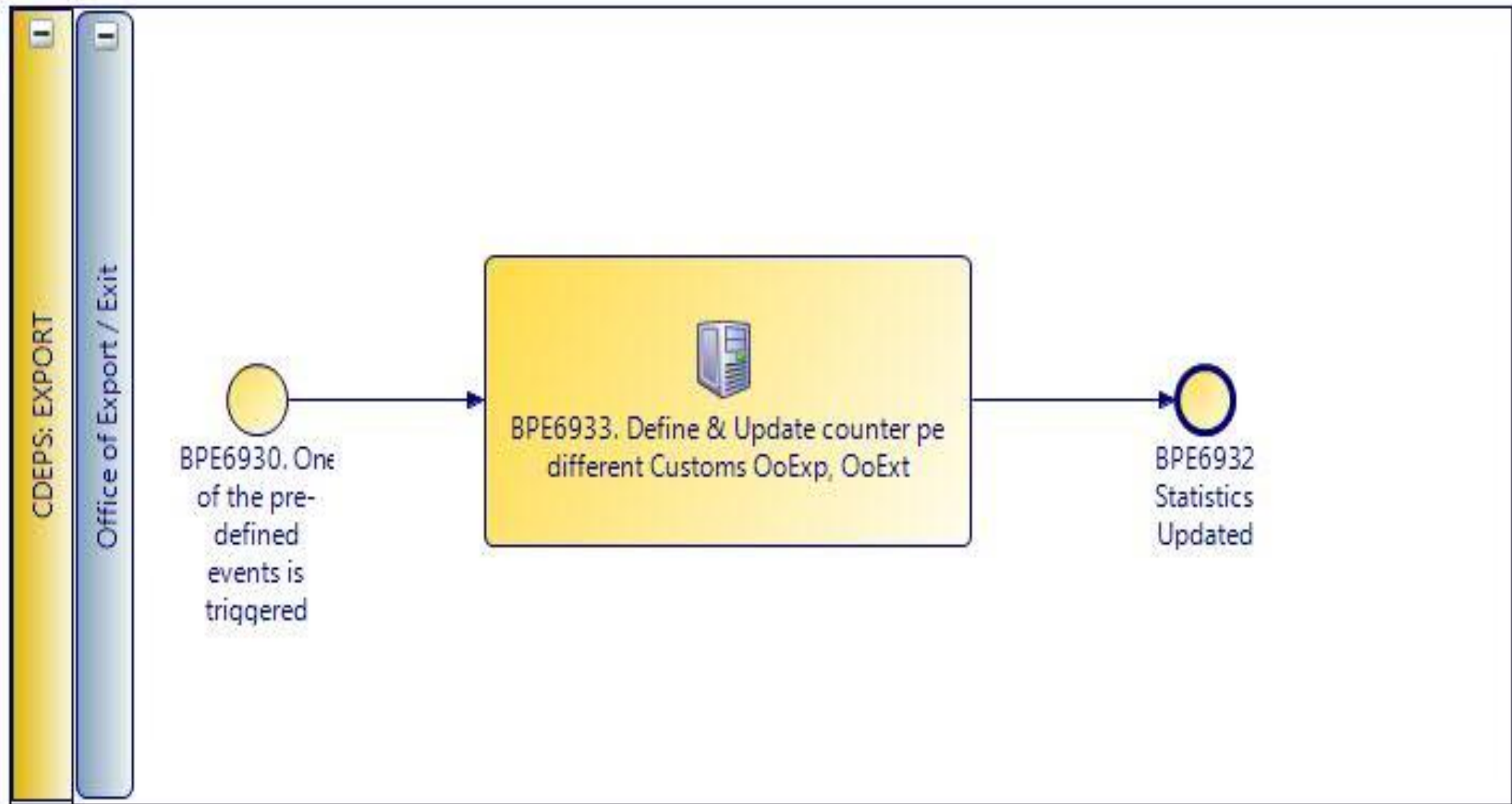

CARM Customs Declaration and Excise Documents Processing system (CDEPS)	REF: CDEPS_EXPORT_BPS
Business Process Specifications for EXPORT System	VER:410

1.1.3.1 Activities

The table below defines the 'Activities' of the 'BP0917. Update Statistics Information' process.

Element Name	Description	Special Type
BPE6933. Define & Update counter per different Customs OoExp, OoExt	Define & Update counter per different Customs OoExp, OoExt.	Service Task

1.1.3.2 Event(s)

The table below defines the 'Event(s)' of the 'BP0917. Update Statistics Information' process.

Element Name	Description	Special Type
BPE6930. One of the pre-defined events is triggered	One of the pre-defined events is triggered.	Start
BPE6932. Statistics Updated	Statistics Updated.	End

CARM Customs Declaration and Excise Documents Processing system (CDEPS)	REF: CDEPS_EXPORT_BPS
Business Process Specifications for EXPORT System	VER:410

1.1.4.BP0026. Process Exit Summary Declaration

Business Process Description

The following table provides general information about the 'BP0026. Process Exit Summary Declaration' process. The Business Process Diagram and the description of various business process elements are specified in the following paragraphs.

Description	Handles the EXS at Office of lodgement, validates, notifies relevant parties of the result and forwards EXS data to Office of Exit
Precondition(s)	The Exit Summary Declaration data are available
Trigger	The process is triggered by the exit summary received electronically by the Trader or manually by the Customs Officer at Office of Lodgement
Postcondition(s)	<ul style="list-style-type: none"> - None - Rejected - Registered

Business Process Diagram

The Business Process Diagram of 'BP0026. Process Exit Summary Declaration' is shown below in BPMN notation. The definition of a process that might be used as sub-process by the 'BP0026. Process Exit Summary Declaration' can be found in this document. Finally, Annex A of CDEPS-BPS-EXPORT provides some explanatory information about the used notation.

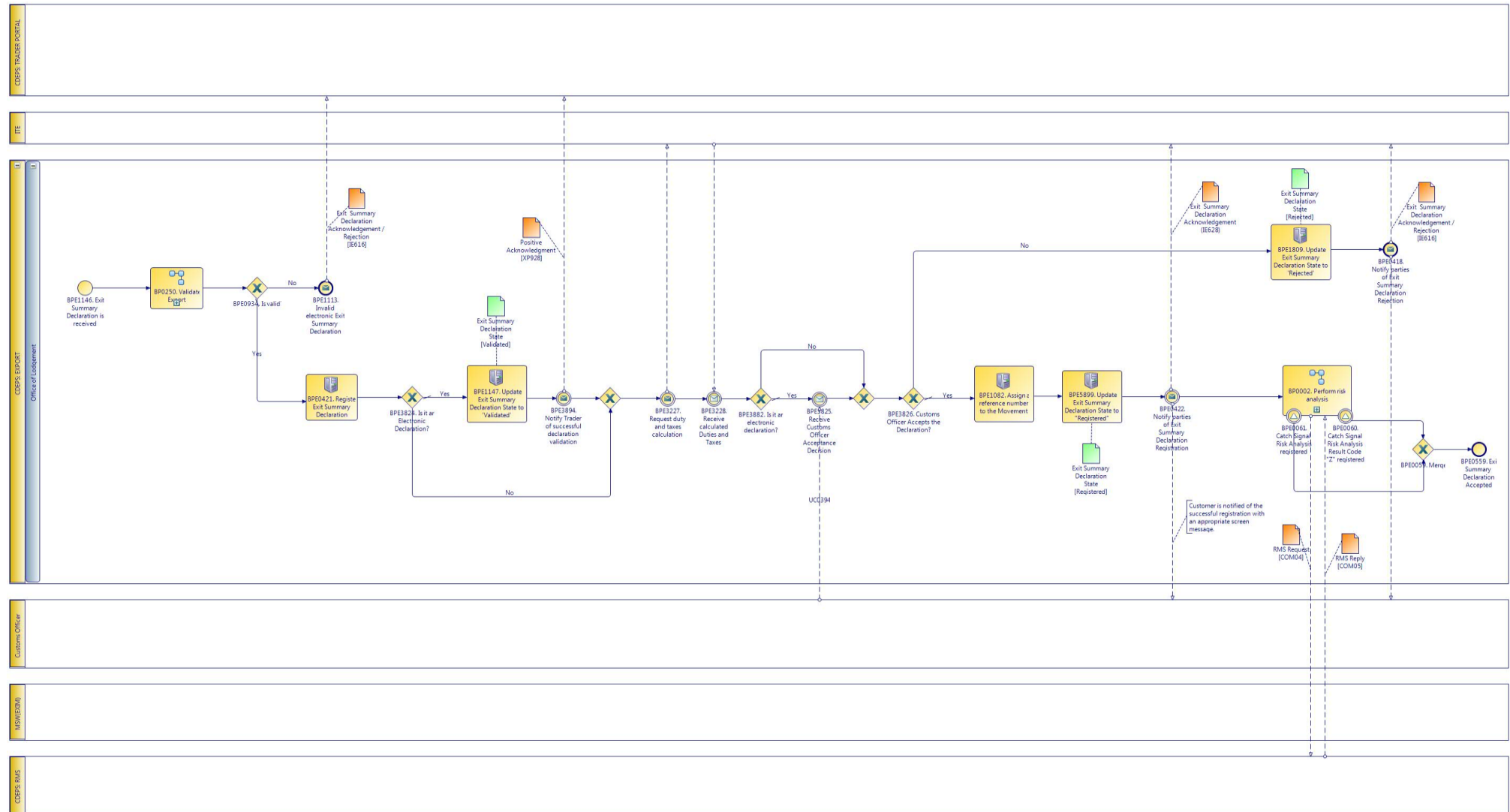

CARM Customs Declaration and Excise Documents Processing system (CDEPS)	REF: CDEPS_EXPORT_BPS
Business Process Specifications for EXPORT System	VER:410

1.1.4.1 Activities

The table below defines the 'Activities' of the 'BP0026. Process Exit Summary Declaration' process.

Element Name	Description	Special Type
BPE0421. Register Exit Summary Declaration	The system registers the exit summary declaration data.	Service Task
BPE1082. Assign a reference number to the Movement	The System assigns a reference number to the Movement	Service Task
↳ Business Rule 253	<i>Movement Reference Number (MRN) Structure</i>	
BPE1147. Update Exit Summary Declaration State to 'Validated'	The system updated the Exit Summary Declaration State to 'Validated'	Service Task
BPE1809. Update Exit Summary Declaration State to 'Rejected'	The system updated the Exit Summary Declaration State to 'Rejected'	Service Task
BPE5899. Update Exit Summary Declaration State to "Registered"	The system updates the Exit Summary Declaration State to "Registered"	Service Task

1.1.4.2 Event(s)

The table below defines the 'Event(s)' of the 'BP0026. Process Exit Summary Declaration' process.

Element Name	Description	Special Type
BPE0061. Catch Signal Risk Analysis registered	Catch Signal Risk Analysis registered (RiskAnalysisCompletedOK).	Intermediate
BPE0416. Receive Exit Summary Declaration	The declaration data is submitted (IE615) to the Office of Lodgement by electronic means. Start	

CARM Customs Declaration and Excise Documents Processing system (CDEPS)	REF: CDEPS_EXPORT_BPS
Business Process Specifications for EXPORT System	VER:410
BPE0418. Notify parties of Exit Summary Declaration Rejection	The validation of received Exit Summary Declaration fails, the corresponding message (IE615) is rejected and is to be notified to the Person Lodging the EXS. End
BPE0422. Notify parties of Exit Summary Declaration Registration	If the declaration is valid, the Office of Lodgement registers the declaration, a MRN is automatically generated. The allocated MRN is communicated (IE628) to the Person Lodging the EXS. Intermediate
BPE0424. Send Exit Summary Declaration and Risk Analysis results	The system forwards the Exit summary Declaration (IE601) to the Declared Office of Exit. Intermediate
BPE0425. Process EXS@OoLdg finalised	The process of registering an EXS at the Office of Lodgment has been finalised. End
BPE0426. Exit Summary Request Rejected	The EXS validation fails, the corresponding message (IE615) is rejected and is to be notified to the Person Lodging the EXS. End
BPE0559. Exit Summary Declaration Accepted	Exit Summary Declaration Accepted End
BPE1113. Invalid electronic Exit Summary Declaration	The Exit Summary declaration is invalid and the process terminates End
BPE1146. Exit Summary Declaration is received	The Exit Summary Declaration is received Start
BPE3227. Request duty and taxes calculation	A request to calculate the duties and taxes is sent to ITE Intermediate
BPE3228. Receive calculated Duties and Taxes	The system receives the calculated Duties and Taxes from ITE Intermediate
BPE3894. Notify Trader of successful declaration validation	The system notifies the Trader of the successful validation of the declaration Intermediate

CARM Customs Declaration and Excise Documents Processing system (CDEPS)	REF: CDEPS_EXPORT_BPS
Business Process Specifications for EXPORT System	VER:410

BPE0060. Catch Signal Risk Analysis Result Code "Z" registered Catch Signal Risk Analysis Result Code "Z" registered (RiskAnalysisZ) Intermediate

1.1.4.3 Gateway(s)

The table below defines the 'Gateway(s)' of the 'BP0026. Process Exit Summary Declaration' process.

Element Name	Description	Special Type
BPE0059. Merge	Merge risk analysis completion signals	Merge
BPE0423. Office of Exit different to Office of Lodgement?	If the OoExt is different to the OoLdg THEN TRUE ELSE FALSE	Decision
↳ Business Rule 58	<i>OoLdg different to OoExt</i>	
BPE0514. Merge Risk Analysis Results	System merging point in order to process the risk analysis results.	Merge
BPE0515. Merge	System merging point in order to finalise the processing of EXS declaration at Office of Lodgment.	Merge
BPE0934. Is Valid?	A decision point in the process to navigate the flow based on the message validation result.	Decision
↳ Business Rule 638	<i>Import declaration type 'X' cannot be cancelled</i>	
↳ Business Rule 646	<i>Guarantees during the registration of Import declaration type 'X'</i>	
↳ Business Rule 80	<i>Valid Message</i>	
BPE3824. Is it an Electronic Declaration?	A decision point in the process to navigate the flow based on whether the declaration is electronic or not	Decision
BPE3825. Receive Customs Officer Acceptance Decision	The system receives Customs Officer acceptance/rejection of the declaration	Decision

CARM Customs Declaration and Excise Documents Processing system (CDEPS)	REF: CDEPS_EXPORT_BPS
Business Process Specifications for EXPORT System	VER:410
BPE3826. Customs Officer Accepts the Declaration?	A decision point in the process to navigate the flow based on whether the declaration is accepted or not Decision
BPE3882. Is it an electronic declaration?	A decision point in the process to navigate the flow based on whether the declaration is electronic or not Decision

CARM Customs Declaration and Excise Documents Processing system (CDEPS)	REF: CDEPS_EXPORT_BPS
Business Process Specifications for EXPORT System	VER:410

1.1.5.BP0250. Validate Export

Business Process Description

The following table provides general information about the 'BP0250. Validate Export' process. The Business Process Diagram and the description of various business process elements are specified in the following paragraphs.

Description	Reusable subprocess that performs the message validation tasks for Export Regime.
Precondition(s)	None
Trigger	The process is triggered when an electronic message is received for validation.
Postcondition(s)	The validation is either completed successfully or with errors reported

Business Process Diagram

The Business Process Diagram of 'BP0250. Validate Export' is shown below in BPMN notation. The definition of a process that might be used as sub-process by the 'BP0250. Validate Export' can be found in this document. Finally, Annex A of CDEPS-BPS-EXPORT provides some explanatory information about the used notation.

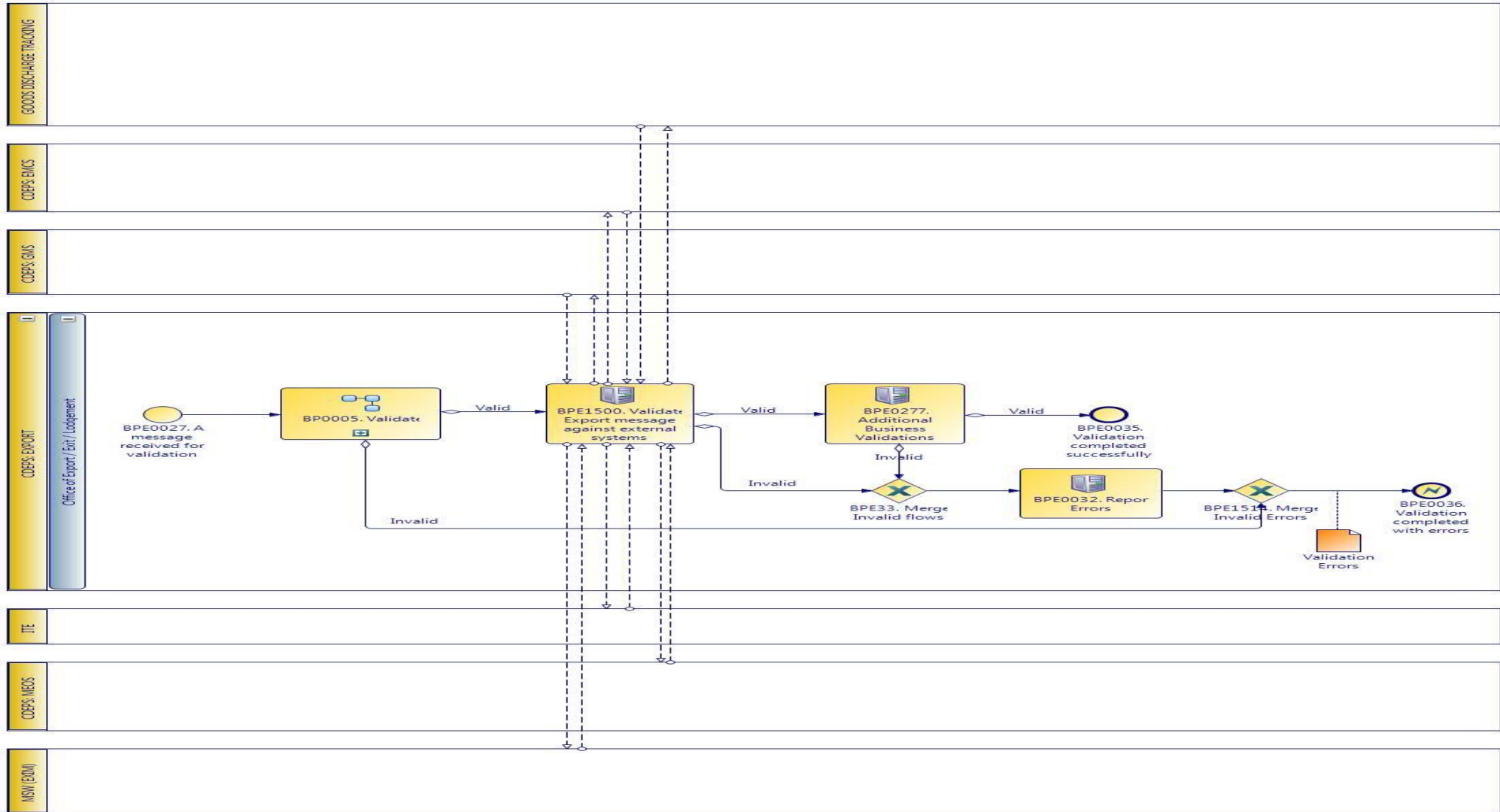

CARM Customs Declaration and Excise Documents Processing system (CDEPS)	REF: CDEPS_EXPORT_BPS
Business Process Specifications for EXPORT System	VER:410

1.1.5.1 Activities

The table below defines the 'Activities' of the 'BP0250. Validate Export' process.

Element Name	Description	Special Type
BPE0032. Report Errors	Report the identified errors from the validation process. The process terminates.	Service Task
BPE0277. Additional Business Validations for Export	The system performs any additional business validations specific to Export System.	Service Task
↳ Business Rule 19	Trader amending data same as Person lodging the declaration	
↳ Business Rule 21	Reject ENS/EXS amendment if ENS/EXS is not in appropriate state	
↳ Business Rule 245	Validate Personal ID	
↳ Business Rule 39	Cancellation Constraint	
↳ Business Rule 520	Import/ Export allowed guarantee types	
↳ Business Rule 70	EXS exists at the Office of Exit	
↳ Business Rule 71	Manifest number in IE547 and IE590	
BPE1500. Validate Export message against external systems	The system performs message validations against external systems.	Service Task
↳ Business Rule 101	Validate Economic Operator against MEOS	
↳ Business Rule 422	Validation of NCTS notifications	
↳ Business Rule 425	Goods Discharge required	
↳ Business Rule 439	Validate against GMS for integrity check	
↳ Business Rule 440	Validate Economic Operator's TIN against MEOS	
↳ Business Rule 494	Orchestrate validation of Export message against external systems	
↳ Business Rule 508	Validation of Export licenses with EXIM	

CARM Customs Declaration and Excise Documents Processing system (CDEPS)	REF: CDEPS_EXPORT_BPS
Business Process Specifications for EXPORT System	VER:410
↳ Business Rule 509	Check Export authorizations with MEOS
↳ Business Rule 51	Validate declared Combined Nomenclature in Declaration against ITE.
↳ Business Rule 510	Check Export authorizations for representation with MEOS
↳ Business Rule 511	Check Evidence of Power of Attorney with MEOS
↳ Business Rule 521	Validate Export declaration against ITE (duty calculation).
↳ Business Rule 522	Validate Export declaration data against Goods Discharge Tracking system
↳ Business Rule 527	Validate Export Declaration data against Excise system

1.1.5.2 Event(s)

The table below defines the 'Event(s)' of the 'BP0250. Validate Export' process.

Element Name	Description	Special Type
BPE0027. A message or event notification from GUI is received for validation	Message input in the validation process.	Start
BPE0035. Validation completed successfully	The validation is completed successfully with no errors reported. The process terminates.	End
BPE0036. Validation completed with errors	The validation completed with errors. The process terminates.	End

1.1.5.3 Gateway(s)

The table below defines the 'Gateway(s)' of the 'BP0250. Validate Export' process.

Element Name	Description	Special Type
BPE1514. Merge Invalid Errors	Combines exclusively either the negative outcome of generic validate process (BP0005. Validate) which reports errors or the errors from the extra checks for the specific system.	Merge

CARM Customs Declaration and Excise Documents Processing system (CDEPS)	REF: CDEPS_EXPORT_BPS
Business Process Specifications for EXPORT System	VER:410

1.1.6.BP0002. Perform risk analysis

Business Process Description

The following table provides general information about the 'BP0002. Perform risk analysis' process. The Business Process Diagram and the description of various business process elements are specified in the following paragraphs.

Description	Reusable subprocess performing the risk analysis task, requesting and handling the response from an external system
Precondition(s)	The declaration is being accepted
Trigger	Risk Analysis request
Postcondition(s)	Risk analysis registered

Business Process Diagram

The Business Process Diagram of 'BP0002. Perform risk analysis' is shown below in BPMN notation. The definition of a process that might be used as sub-process by the 'BP0002. Perform risk analysis' can be found in this document. Finally, Annex A of CDEPS-BPS-EXPORT provides some explanatory information about the used notation.

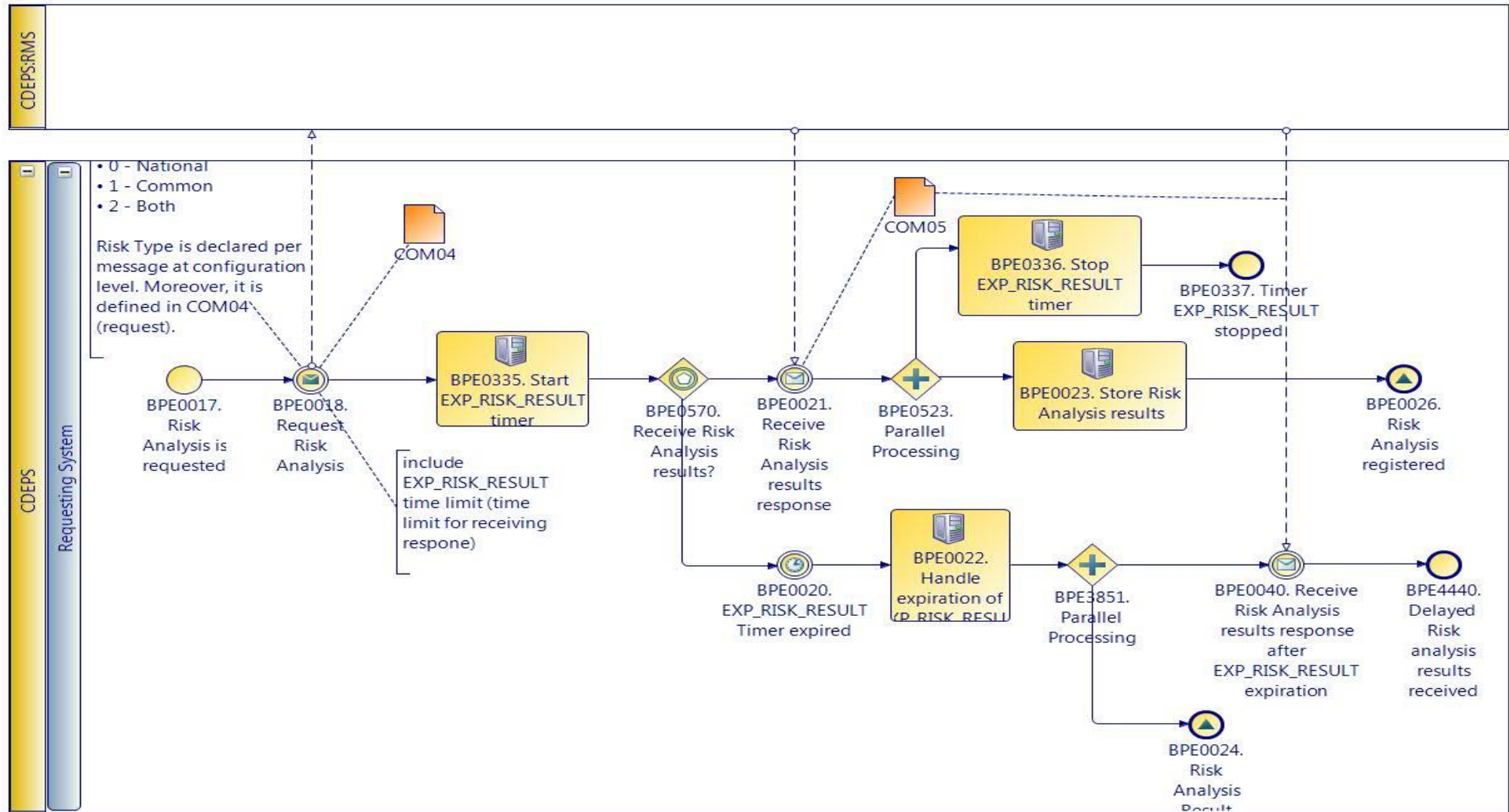

CARM Customs Declaration and Excise Documents Processing system (CDEPS)	REF: CDEPS_EXPORT_BPS
Business Process Specifications for EXPORT System	VER:410

1.1.6.1 Activities

The table below defines the 'Activities' of the 'BP0002. Perform risk analysis' process.

Element Name	Description	Special Type
BPE0018. Request Risk Analysis	When a risk analysis has to be performed, the system prepare and submit a risk analysis request (COM04) to the RMS. This request includes among other information, the risk analysis type and the message for which is risk analysis is requested.	Send Task
BPE0022. Handle expiration of EXP_RISK_RESULT timer.	The system performs the following actions: - registers Risk Analysis result "Z" in order to resume the process. - generates and assigns a random national risk score by employing the national risk algorithm - risk registers delayed Risk Analysis Results.	Service Task
↳ Business Rule 517	<i>Generation of random national risk score</i>	
BPE0023. Store Risk Analysis results	The system registers the received risk analysis results successfully.	Service Task
BPE0335. Start EXP_RISK_RESULT timer	Starts the EXP_RISK_RESULT timer.	User Task
BPE0336. Stop EXP_RISK_RESULT timer	Stop the EXP_RISK_RESULT timer when the Risk Analysis Results (COM05) are received from the RMS.	User Task

1.1.6.2 Event(s)

The table below defines the 'Event(s)' of the 'BP0002. Perform risk analysis' process.

Element Name	Description	Special Type
BPE0017. Risk Analysis is requested	A request is received for performing a risk analysis.	Start
BPE0020. EXP_RISK_RESULT Timer expired	No response is received on time (EXP_RISK_RESULT Timer for risk analysis results response expired)	Intermediate

CARM Customs Declaration and Excise Documents Processing system (CDEPS)	REF: CDEPS_EXPORT_BPS
Business Process Specifications for EXPORT System	VER:410

BPE0021. Receive Risk Analysis results response	Receive the risk analysis results (COM05) on time	Intermediate
BPE0024. Risk Analysis Result Code "Z" registered	A signal "Risk Analysis Result Code "Z" registered" is disseminated for resuming the process requested the risk analysis while at the same time the system expects the risk analysis results at some point of time.	End
BPE0026. Risk Analysis registered	The process ends with the successful registration of risk analysis results	End
BPE0040. Receive Risk Analysis results response after EXP_RISK_RESULT expiration	At some point of time, the system receives the risk analysis results after the expiration of EXP_RISK_RESULT Timer for risk analysis results response.	Intermediate
BPE0337. Timer EXP_RISK_RESULT stopped	This is the ending event in regards to the Timer (T1) stop.	End
BPE4440. Delayed Risk analysis results received	Delayed Risk analysis results received	End

1.1.6.3 Gateway(s)

The table below defines the 'Gateway(s)' of the 'BP0002. Perform risk analysis' process.

Element Name	Description	Special Type
BPE0523. Parallel Processing	Stop timer and store risk analysis results	Fork
BPE0570. Receive Risk Analysis results?	Receive Risk Analysis results response or timer waiting results expired?	Decision
BPE3851. Parallel Processing	Divide the path in two or more parallel paths (concurrent execution of tasks).	Fork

CARM Customs Declaration and Excise Documents Processing system (CDEPS)	REF: CDEPS_EXPORT_BPS
Business Process Specifications for EXPORT System	VER:410

1.1.7.BP0005. Validate

Business Process Description

The following table provides general information about the 'BP0005. Validate' process. The Business Process Diagram and the description of various business process elements are specified in the following paragraphs.

Description	Reusable subprocess that performs the message validation tasks
Precondition(s)	None
Trigger	The process is triggered when an electronic message is received for validation.
Postcondition(s)	

Business Process Diagram

The Business Process Diagram of 'BP0005. Validate' is shown below in BPMN notation. The definition of a process that might be used as sub-process by the 'BP0005. Validate' can be found in this document. Finally, Annex A of CDEPS-BPS-EXPORT provides some explanatory information about the used notation.

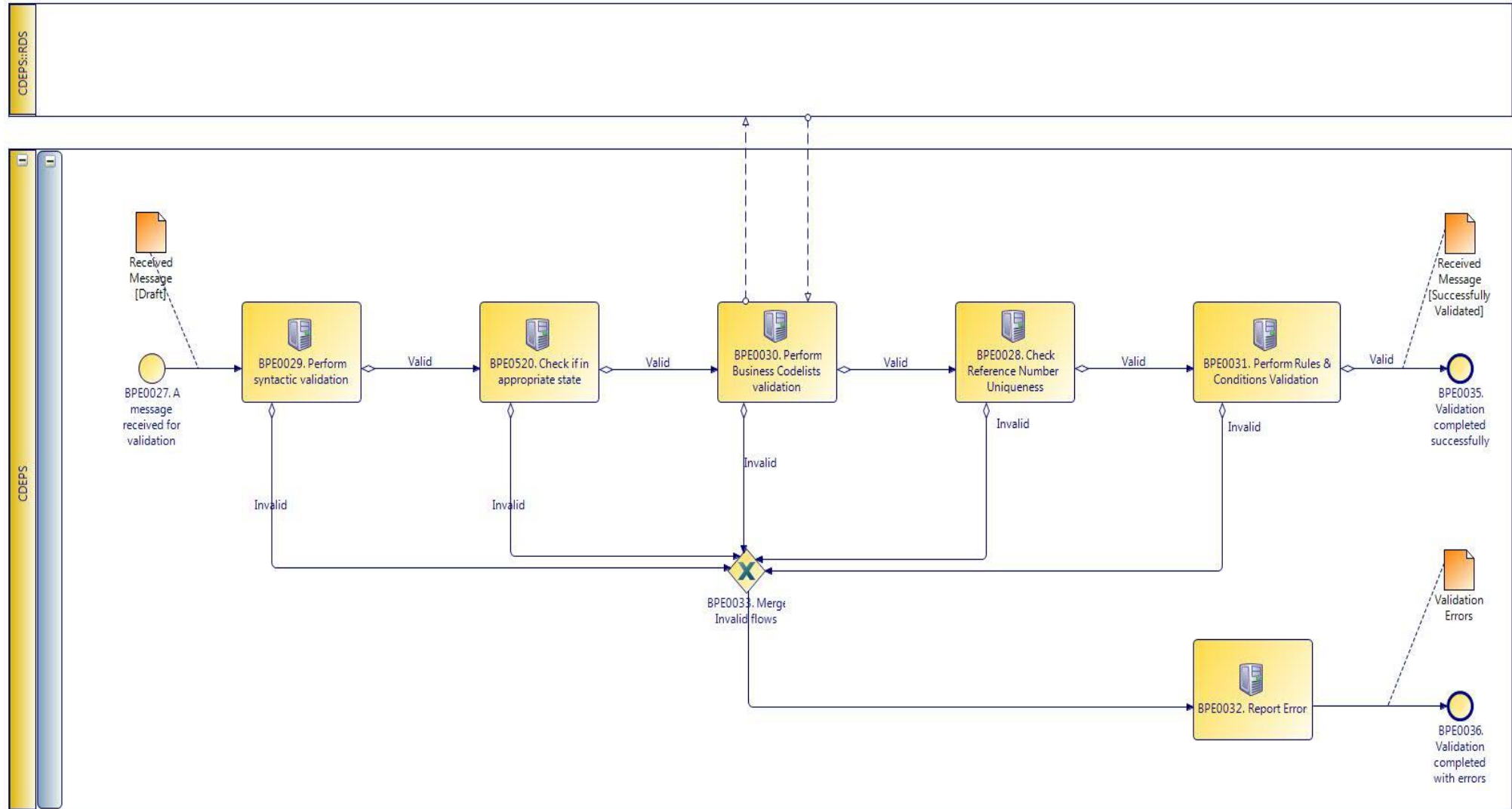

CARM Customs Declaration and Excise Documents Processing system (CDEPS)	REF: CDEPS_EXPORT_BPS
Business Process Specifications for EXPORT System	VER:410

1.1.7.1 Activities

The table below defines the 'Activities' of the 'BP0005. Validate' process.

Element Name	Description	Special Type
BPE0028. Check Reference Number Uniqueness	Check whether message reference numbers are unique in the system.	Service Task
↳ Business Rule 1	<i>Check Message Identification uniqueness</i>	
↳ Business Rule 74	<i>Check Local Reference Number (LRN) uniqueness</i>	
↳ Business Rule 75	<i>Check Movement Reference Number (MRN)uniqueness</i>	
↳ Business Rule 79	<i>Check Manifest reference number uniqueness</i>	
BPE0029. Perform syntactic validation	Check messages against the XSDs.	Service Task
↳ Business Rule 47	<i>Syntactic validation</i>	
BPE0030. Perform Business Codelists validation	Check the message business codelists.	Service Task
↳ Business Rule 50	<i>Business codelist validation against CDEPS:RDS</i>	
BPE0031. Perform Rules & Conditions Validation	Check the rules and conditions of the respective message.	Service Task
BPE0032. Report Errors	Report the identified errors from the validation process. The process terminates.	Service Task
BPE0520. Check if in appropriate state	Check whether the process for the particular entity (e.g. declaration/ application/ document) is on the appropriate state to process the received message. This check shall be performed based on the pertinent State Model of the system.	Service Task
↳ Business Rule 421	<i>Supplementary Declaration validation at Export</i>	
↳ Business Rule 448	<i>Check appropriate state for Export Declaration Amendment</i>	

CARM Customs Declaration and Excise Documents Processing system (CDEPS)	REF: CDEPS_EXPORT_BPS
Business Process Specifications for EXPORT System	VER:410

- ↳ **Business Rule** 449 *Check appropriate state Declaration Goods Presentation*
- ↳ **Business Rule** 468 *Guarantee Amendment*
- ↳ **Business Rule** 492 *Exit control results received at Export*
- ↳ **Business Rule** 493 *Export Declaration request at Export*

1.1.7.2 Event(s)

The table below defines the 'Event(s)' of the 'BP0005. Validate' process.

Element Name	Description	Special Type
BPE0027. A message or event notification from GUI is received for validation	Message input in the validation process.	Start
BPE0035. Validation completed successfully	The validation is completed successfully with no errors reported. The process terminates.	End
BPE0036. Validation completed with errors	The validation completed with errors. The process terminates.	End

1.1.7.3 Gateway(s)

The table below defines the 'Gateway(s)' of the 'BP0005. Validate' process.

Element Name	Description	Special Type
BPE0033. Merge Invalid Flows	Merge into exclusive event based gateway the invalid flows from all validation tasks.	Merge

CARM Customs Declaration and Excise Documents Processing system (CDEPS)	REF: CDEPS_EXPORT_BPS
Business Process Specifications for EXPORT System	VER:410

1.2. Process Group: Exit Summary Declaration processing at Exit

1.2.1.BP0915. Retrieve Statistics Information

Business Process Description

The following table provides general information about the 'BP0915. Retrieve Statistics Information' process. The Business Process Diagram and the description of various business process elements are specified in the following paragraphs.

Description	Handles the Business Statistics at Export Control System and sending the IE411 to CS/MIS.
Precondition(s)	
Trigger	
Postcondition(s)	

Business Process Diagram

The Business Process Diagram of 'BP0915. Retrieve Statistics Information' is shown below in BPMN notation. The definition of a process that might be used as sub-process by the 'BP0915. Retrieve Statistics Information' can be found in this document. Finally, Annex A of CDEPS-BPS-EXPORT provides some explanatory information about the used notation.

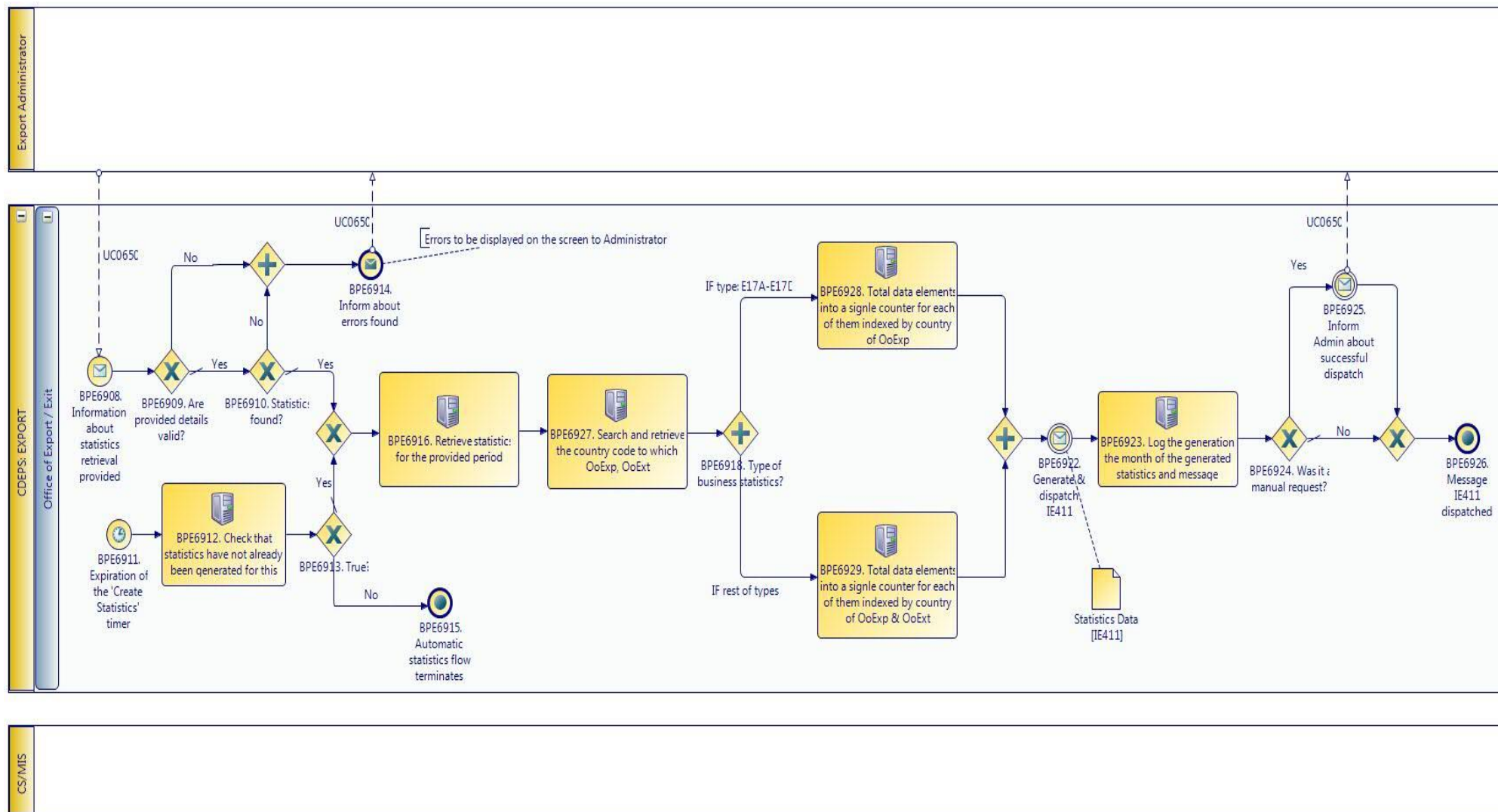

CARM Customs Declaration and Excise Documents Processing system (CDEPS)	REF: CDEPS_EXPORT_BPS
Business Process Specifications for EXPORT System	VER:410

1.2.1.1 Activities

The table below defines the 'Activities' of the 'BP0915. Retrieve Statistics Information' process.

Element Name	Description	Special Type
BPE6912. Check that statistics have not already been generated for this	Check that statistics have not already been generated for this	Service Task
BPE6916. Retrieve statistics for the provided period	Retrieve statistics for the provided period.	Service Task
BPE6923. Log the generation, the month of the generated statistics and message	Log the generation, the month of the generated statistics and message.	Service Task
BPE6927. Search and retrieve the country code to which OoExp, OoExt	Search and retrieve the country code to which OoExp, OoExt.	Service Task
BPE6928. Total data elements into a single counter for each of them indexed by country of OoExp	Total data elements into a single counter for each of them indexed by country of OoExp.	Service Task
BPE6929. Total data elements into a single counter for each of them indexed by country of OoExp & OoExt	Total data elements into a single counter for each of them indexed by country of OoExp & OoExt.	Service Task

CARM Customs Declaration and Excise Documents Processing system (CDEPS)	REF: CDEPS_EXPORT_BPS
Business Process Specifications for EXPORT System	VER:410

1.2.1.2 Event(s)

The table below defines the 'Event(s)' of the 'BP0915. Retrieve Statistics Information' process.

Element Name	Description	Special Type
BPE6908. Information about statistics retrieval provided	Information about statistics retrieval provided by the administrator.	Start
BPE6911. Expiration of the 'Create Statistics' timer	Expiration of the 'Create Statistics' timer.	Start
BPE6914. Inform about errors found	Inform about errors found.	End
BPE6915. Automatic statistics flow terminates	Automatic statistics flow terminates.	End
BPE6922. Generate & dispatch IE411	Generate & dispatch IE411.	Intermediate
BPE6925. Inform Admin about successful dispatch	Inform Admin about successful dispatch.	Intermediate
BPE6926. Message IE411 dispatched	Message IE411 dispatched.	End

1.2.1.3 Gateway(s)

The table below defines the 'Gateway(s)' of the 'BP0915. Retrieve Statistics Information' process.

Element Name	Description	Special Type
BPE6909. Are provided details valid?	Are provided details valid?	Decision
BPE6910. Statistics found?	Statistics found?	Decision
BPE6913. True?	True?	Decision

CARM Customs Declaration and Excise Documents Processing system (CDEPS)	REF: CDEPS_EXPORT_BPS
Business Process Specifications for EXPORT System	VER:410

BPE6918. Type of business statistics?	Type of business statistics?	Decision
BPE6924. Was it a manual request?	Was it a manual request?	Decision

CARM Customs Declaration and Excise Documents Processing system (CDEPS)	REF: CDEPS_EXPORT_BPS
Business Process Specifications for EXPORT System	VER:410

1.2.2.BP0917. Update Statistics Information

Business Process Description

The following table provides general information about the 'BP0917. Update Statistics Information' process. The Business Process Diagram and the description of various business process elements are specified in the following paragraphs.

Description	Handles the updating of Business Statistics at Export Control System.
Precondition(s)	
Trigger	
Postcondition(s)	

Business Process Diagram

The Business Process Diagram of 'BP0917. Update Statistics Information' is shown below in BPMN notation. The definition of a process that might be used as sub-process by the 'BP0917. Update Statistics Information' can be found in this document. Finally, Annex A of CDEPS-BPS-EXPORT provides some explanatory information about the used notation.

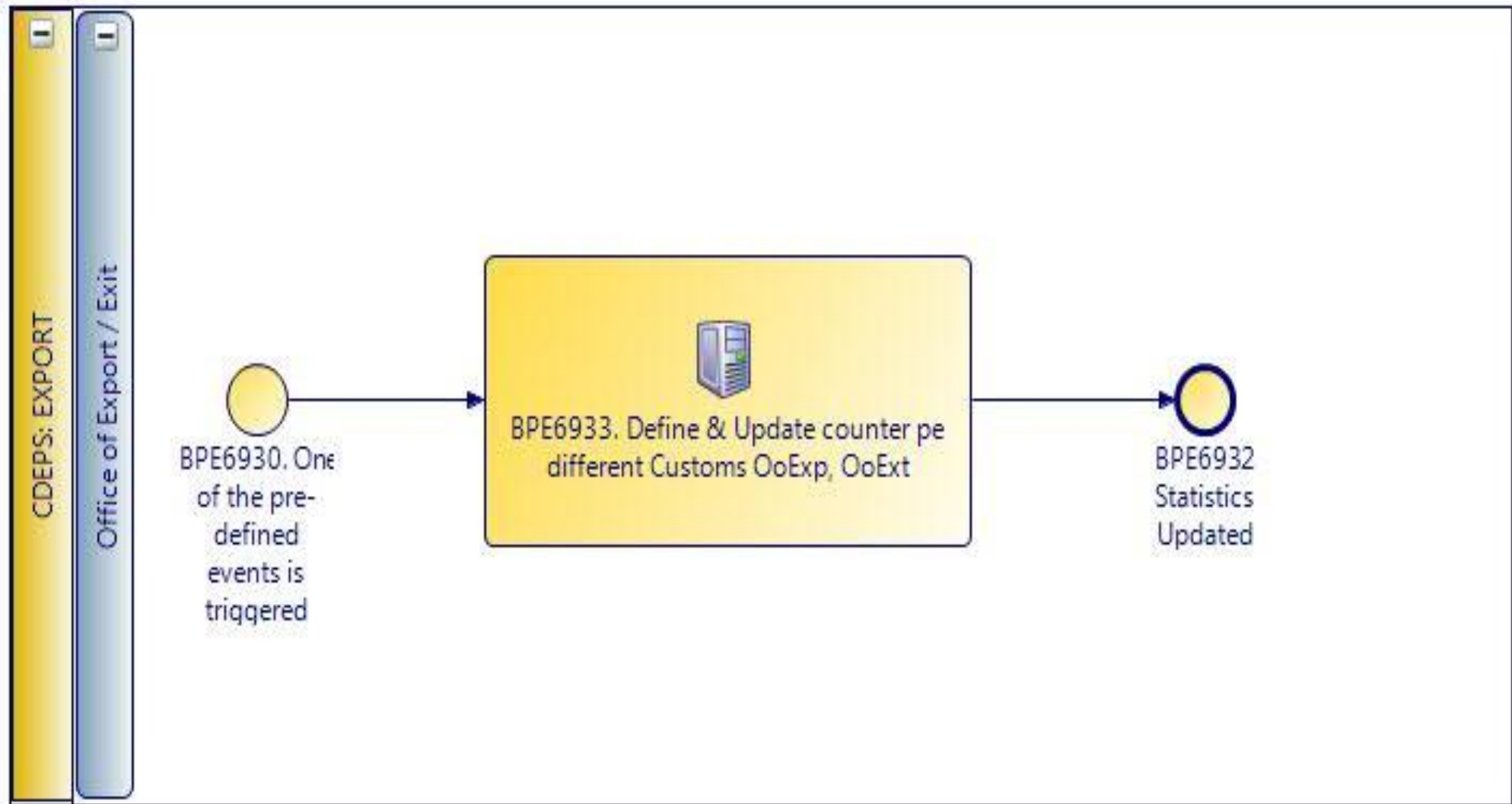

CARM Customs Declaration and Excise Documents Processing system (CDEPS)	REF: CDEPS_EXPORT_BPS
Business Process Specifications for EXPORT System	VER:410

1.2.2.1 Activities

The table below defines the 'Activities' of the 'BP0917. Update Statistics Information' process.

Element Name	Description	Special Type
BPE6933. Define & Update counter per different Customs OoExp, OoExt	Define & Update counter per different Customs OoExp, OoExt.	Service Task

1.2.2.2 Event(s)

The table below defines the 'Event(s)' of the 'BP0917. Update Statistics Information' process.

Element Name	Description	Special Type
BPE6930. One of the pre-defined events is triggered	One of the pre-defined events is triggered.	Start
BPE6932. Statistics Updated	Statistics Updated.	End

CARM Customs Declaration and Excise Documents Processing system (CDEPS)	REF: CDEPS_EXPORT_BPS
Business Process Specifications for EXPORT System	VER:410

1.2.3.BP0157. Process Exit Summary Declaration @ Declared Office of Exit

Business Process Description

The following table provides general information about the 'BP0157. Process Exit Summary Declaration @ Declared Office of Exit' process. The Business Process Diagram and the description of various business process elements are specified in the following paragraphs.

Description	A master process that processes the Exit Summary Declaration at the Office of Exit
Precondition(s)	None
Trigger	The process is triggered by the Exit Summary declaration received electronically at the Declared Office of Exit
Postcondition(s)	- None - EXS Created

Business Process Diagram

The Business Process Diagram of 'BP0157. Process Exit Summary Declaration @ Declared Office of Exit' is shown below in BPMN notation. The definition of a process that might be used as sub-process by the 'BP0157. Process Exit Summary Declaration @ Declared Office of Exit' can be found in this document. Finally, Annex A of CDEPS-BPS-EXPORT provides some explanatory information about the used notation.

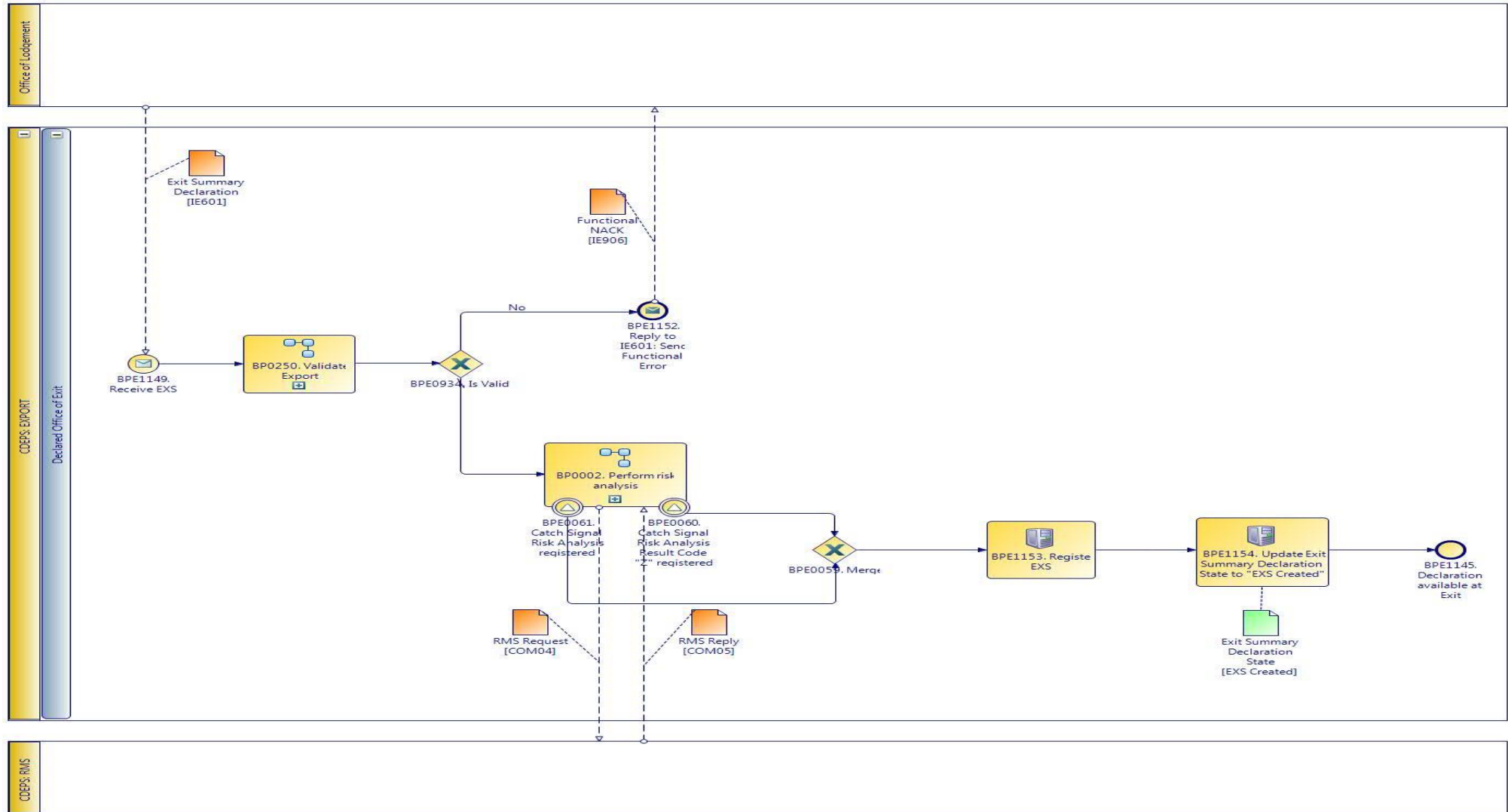

CARM Customs Declaration and Excise Documents Processing system (CDEPS)	REF: CDEPS_EXPORT_BPS
Business Process Specifications for EXPORT System	VER:410

1.2.3.1 Activities

The table below defines the 'Activities' of the 'BP0157. Process Exit Summary Declaration @ Declared Office of Exit' process.

Element Name	Description	Special Type
BPE1153. Register EXS	The Exit Summary Declaration is stored in the system	Service Task
BPE1154. Update Exit Summary Declaration State to "EXS Created"	The system updates the Exit Summary Declaration State to "EXS Created"	Service Task

1.2.3.2 Event(s)

The table below defines the 'Event(s)' of the 'BP0157. Process Exit Summary Declaration @ Declared Office of Exit' process.

Element Name	Description	Special Type
BPE1145. Declaration available at Exit	The declaration is available at Exit and the process terminates	End
BPE1149. Receive EXS	The Office of Exit receives the Exit Summary Declaration	Start
BPE1152. Reply to IE601: Send Functional Error	Reply to IE601: Send Functional Error	End

1.2.3.3 Gateway(s)

The table below defines the 'Gateway(s)' of the 'BP0157. Process Exit Summary Declaration @ Declared Office of Exit' process.

Element Name	Description	Special Type
BPE0934. Is Valid?	A decision point in the process to navigate the flow based on the message validation result.	Decision
↳ Business Rule 638	<i>Import declaration type 'X' cannot be cancelled</i>	
↳ Business Rule 646	<i>Guarantees during the registration of Import declaration type 'X'</i>	
↳ Business Rule 80	<i>Valid Message</i>	

CARM Customs Declaration and Excise Documents Processing system (CDEPS)	REF: CDEPS_EXPORT_BPS
Business Process Specifications for EXPORT System	VER:410

1.2.4.BP0250. Validate Export

Business Process Description

The following table provides general information about the 'BP0250. Validate Export' process. The Business Process Diagram and the description of various business process elements are specified in the following paragraphs.

Description	Reusable subprocess that performs the message validation tasks for Export Regime.
Precondition(s)	None
Trigger	The process is triggered when an electronic message is received for validation.
Postcondition(s)	The validation is either completed successfully or with errors reported

Business Process Diagram

The Business Process Diagram of 'BP0250. Validate Export' is shown below in BPMN notation. The definition of a process that might be used as sub-process by the 'BP0250. Validate Export' can be found in this document. Finally, Annex A of CDEPS-BPS-EXPORT provides some explanatory information about the used notation.

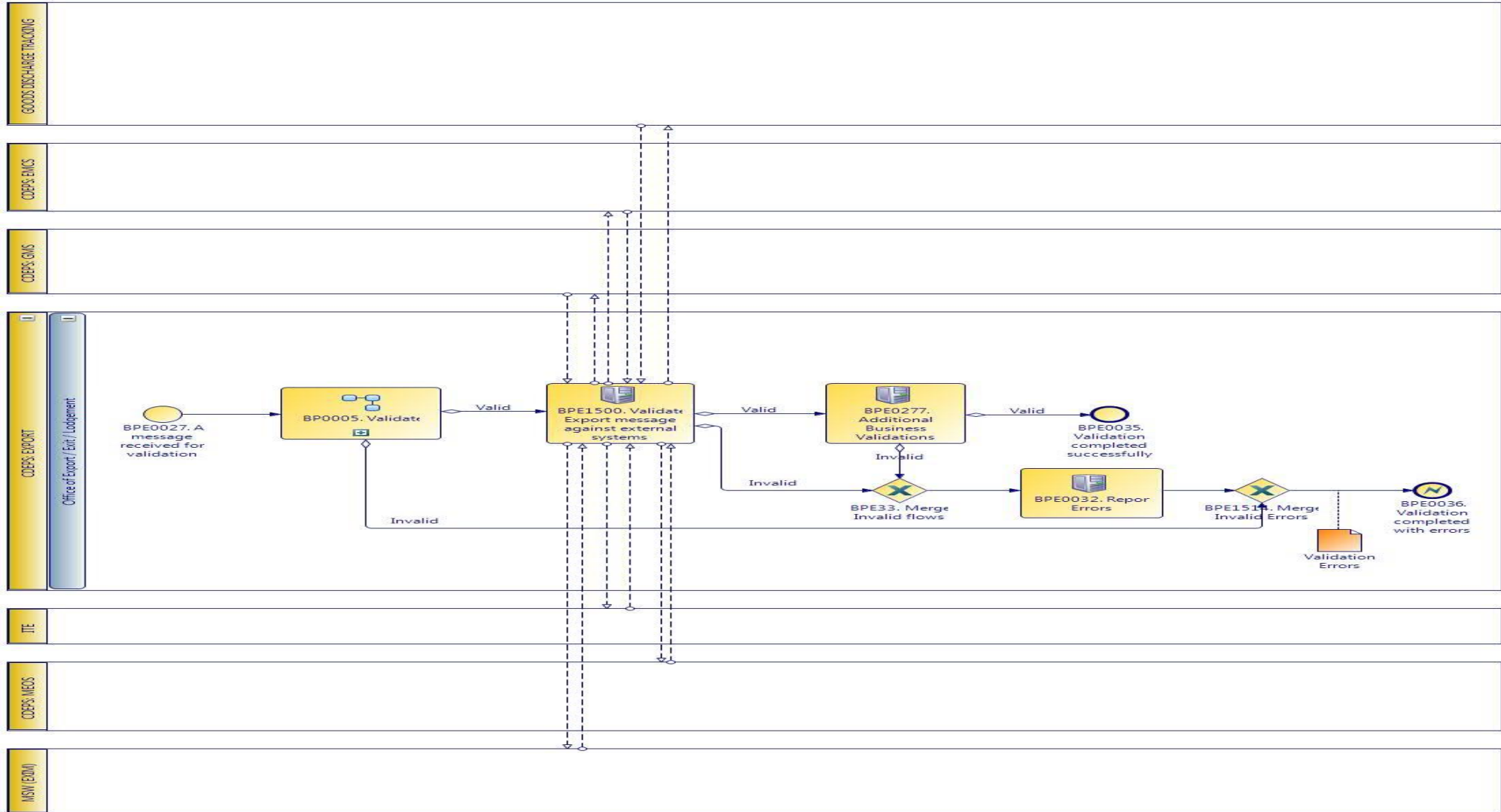

CARM Customs Declaration and Excise Documents Processing system (CDEPS)	REF: CDEPS_EXPORT_BPS
Business Process Specifications for EXPORT System	VER:410

1.2.4.1 Activities

The table below defines the 'Activities' of the 'BP0250. Validate Export' process.

Element Name	Description	Special Type
BPE0032. Report Errors	Report the identified errors from the validation process. The process terminates.	Service Task
BPE0277. Additional Business Validations for Export	The system performs any additional business validations specific to Export System.	Service Task
↳ Business Rule 19	Trader amending data same as Person lodging the declaration	
↳ Business Rule 21	Reject ENS/EXS amendment if ENS/EXS is not in appropriate state	
↳ Business Rule 245	Validate Personal ID	
↳ Business Rule 39	Cancellation Constraint	
↳ Business Rule 520	Import/ Export allowed guarantee types	
↳ Business Rule 70	EXS exists at the Office of Exit	
↳ Business Rule 71	Manifest number in IE547 and IE590	
BPE1500. Validate Export message against external systems	The system performs message validations against external systems.	Service Task
↳ Business Rule 101	Validate Economic Operator against MEOS	
↳ Business Rule 422	Validation of NCTS notifications	
↳ Business Rule 425	Goods Discharge required	
↳ Business Rule 439	Validate against GMS for integrity check	
↳ Business Rule 440	Validate Economic Operator's TIN against MEOS	
↳ Business Rule 494	Orchestrate validation of Export message against external systems	
↳ Business Rule 508	Validation of Export licenses with EXIM	

CARM Customs Declaration and Excise Documents Processing system (CDEPS)	REF: CDEPS_EXPORT_BPS
Business Process Specifications for EXPORT System	VER:410
↳ Business Rule 509	Check Export authorizations with MEOS
↳ Business Rule 51	Validate declared Combined Nomenclature in Declaration against ITE.
↳ Business Rule 510	Check Export authorizations for representation with MEOS
↳ Business Rule 511	Check Evidence of Power of Attorney with MEOS
↳ Business Rule 521	Validate Export declaration against ITE (duty calculation).
↳ Business Rule 522	Validate Export declaration data against Goods Discharge Tracking system
↳ Business Rule 527	Validate Export Declaration data against Excise system

1.2.4.2 Event(s)

The table below defines the 'Event(s)' of the 'BP0250. Validate Export' process.

Element Name	Description	Special Type
BPE0027. A message or event notification from GUI is received for validation	Message input in the validation process.	Start
BPE0035. Validation completed successfully	The validation is completed successfully with no errors reported. The process terminates.	End
BPE0036. Validation completed with errors	The validation completed with errors. The process terminates.	End

1.2.4.3 Gateway(s)

The table below defines the 'Gateway(s)' of the 'BP0250. Validate Export' process.

Element Name	Description	Special Type
BPE1514. Merge Invalid Errors	Combines exclusively either the negative outcome of generic validate process (BP0005. Validate) which reports errors or the errors from the extra checks for the specific system.	Merge

CARM Customs Declaration and Excise Documents Processing system (CDEPS)	REF: CDEPS_EXPORT_BPS
Business Process Specifications for EXPORT System	VER:410

1.2.5.BP0002. Perform risk analysis

Business Process Description

The following table provides general information about the 'BP0002. Perform risk analysis' process. The Business Process Diagram and the description of various business process elements are specified in the following paragraphs.

Description	Reusable subprocess performing the risk analysis task, requesting and handling the response from an external system
Precondition(s)	The declaration is being accepted
Trigger	Risk Analysis request
Postcondition(s)	Risk analysis registered

Business Process Diagram

The Business Process Diagram of 'BP0002. Perform risk analysis' is shown below in BPMN notation. The definition of a process that might be used as sub-process by the 'BP0002. Perform risk analysis' can be found in this document. Finally, Annex A of CDEPS-BPS-EXPORT provides some explanatory information about the used notation.

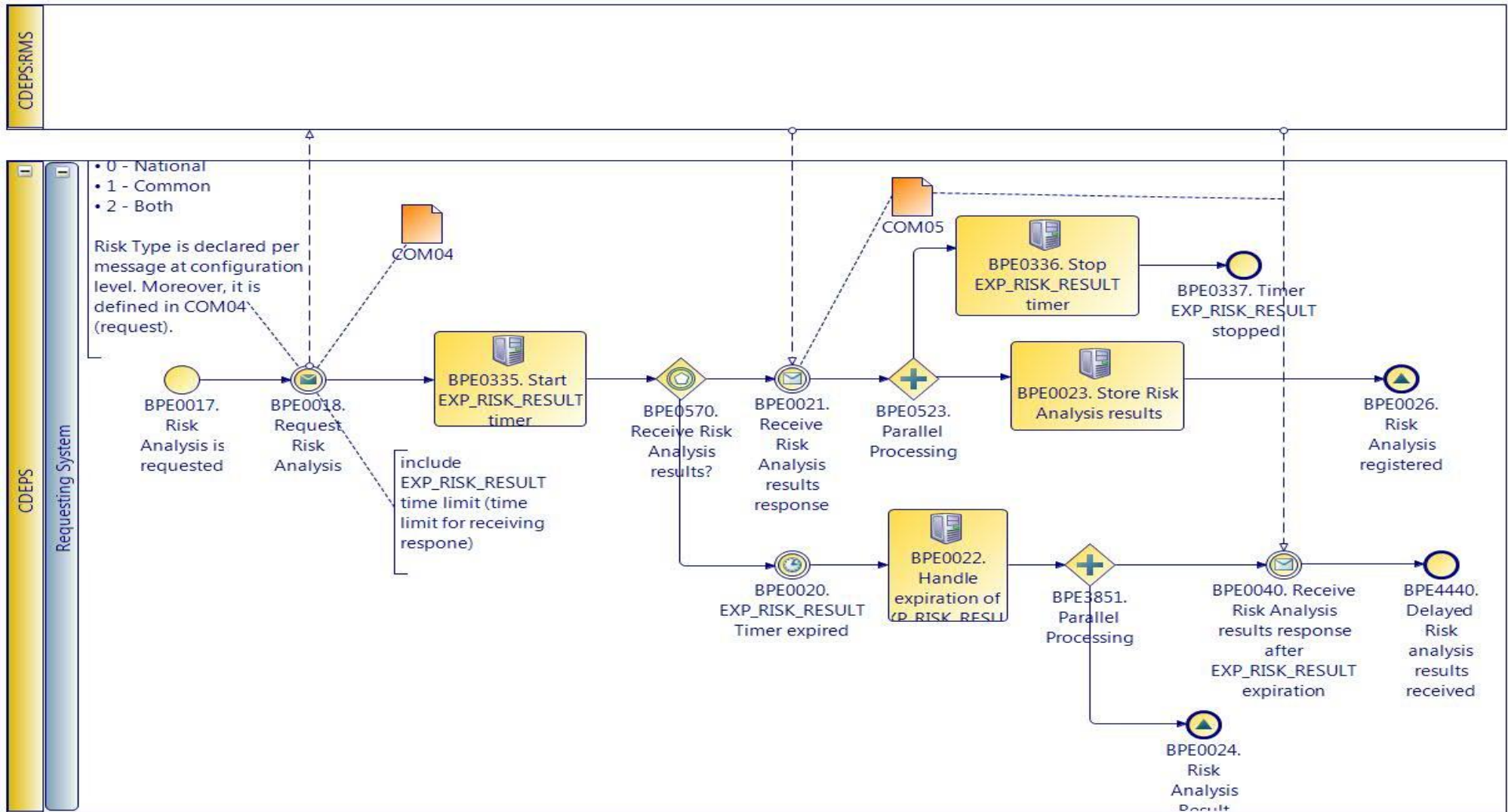

CARM Customs Declaration and Excise Documents Processing system (CDEPS)	REF: CDEPS_EXPORT_BPS
Business Process Specifications for EXPORT System	VER:410

1.2.5.1 Activities

The table below defines the 'Activities' of the 'BP0002. Perform risk analysis' process.

Element Name	Description	Special Type
BPE0018. Request Risk Analysis	When a risk analysis has to be performed, the system prepare and submit a risk analysis request (COM04) to the RMS. This request includes among other information, the risk analysis type and the message for which is risk analysis is requested.	Send Task
BPE0022. Handle expiration of EXP_RISK_RESULT timer.	The system performs the following actions: - registers Risk Analysis result "Z" in order to resume the process. - generates and assigns a random national risk score by employing the national risk algorithm - risk registers delayed Risk Analysis Results.	Service Task
↳ Business Rule 517	<i>Generation of random national risk score</i>	
BPE0023. Store Risk Analysis results	The system registers the received risk analysis results successfully.	Service Task
BPE0335. Start EXP_RISK_RESULT timer	Starts the EXP_RISK_RESULT timer.	User Task
BPE0336. Stop EXP_RISK_RESULT timer	Stop the EXP_RISK_RESULT timer when the Risk Analysis Results (COM05) are received from the RMS.	User Task

1.2.5.2 Event(s)

The table below defines the 'Event(s)' of the 'BP0002. Perform risk analysis' process.

Element Name	Description	Special Type
BPE0017. Risk Analysis is requested	A request is received for performing a risk analysis.	Start
BPE0020. EXP_RISK_RESULT Timer expired	No response is received on time (EXP_RISK_RESULT Timer for risk analysis results response expired)	Intermediate

CARM Customs Declaration and Excise Documents Processing system (CDEPS)	REF: CDEPS_EXPORT_BPS
Business Process Specifications for EXPORT System	VER:410

BPE0021. Receive Risk Analysis results response	Receive the risk analysis results (COM05) on time	Intermediate
BPE0024. Risk Analysis Result Code "Z" registered	A signal "Risk Analysis Result Code "Z" registered" is disseminated for resuming the process requested the risk analysis while at the same time the system expects the risk analysis results at some point of time.	End
BPE0026. Risk Analysis registered	The process ends with the successful registration of risk analysis results	End
BPE0040. Receive Risk Analysis results response after EXP_RISK_RESULT expiration	At some point of time, the system receives the risk analysis results after the expiration of EXP_RISK_RESULT Timer for risk analysis results response.	Intermediate
BPE0337. Timer EXP_RISK_RESULT stopped	This is the ending event in regards to the Timer (T1) stop.	End
BPE4440. Delayed Risk analysis results received	Delayed Risk analysis results received	End

1.2.5.3 Gateway(s)

The table below defines the 'Gateway(s)' of the 'BP0002. Perform risk analysis' process.

Element Name	Description	Special Type
BPE0523. Parallel Processing	Stop timer and store risk analysis results	Fork
BPE0570. Receive Risk Analysis results?	Receive Risk Analysis results response or timer waiting results expired?	Decision
BPE3851. Parallel Processing	Divide the path in two or more parallel paths (concurrent execution of tasks).	Fork

CARM Customs Declaration and Excise Documents Processing system (CDEPS)	REF: CDEPS_EXPORT_BPS
Business Process Specifications for EXPORT System	VER:410

1.2.6.BP0005. Validate

Business Process Description

The following table provides general information about the 'BP0005. Validate' process. The Business Process Diagram and the description of various business process elements are specified in the following paragraphs.

Description	Reusable subprocess that performs the message validation tasks
Precondition(s)	None
Trigger	The process is triggered when an electronic message is received for validation.
Postcondition(s)	

Business Process Diagram

The Business Process Diagram of 'BP0005. Validate' is shown below in BPMN notation. The definition of a process that might be used as sub-process by the 'BP0005. Validate' can be found in this document. Finally, Annex A of CDEPS-BPS-EXPORT provides some explanatory information about the used notation.

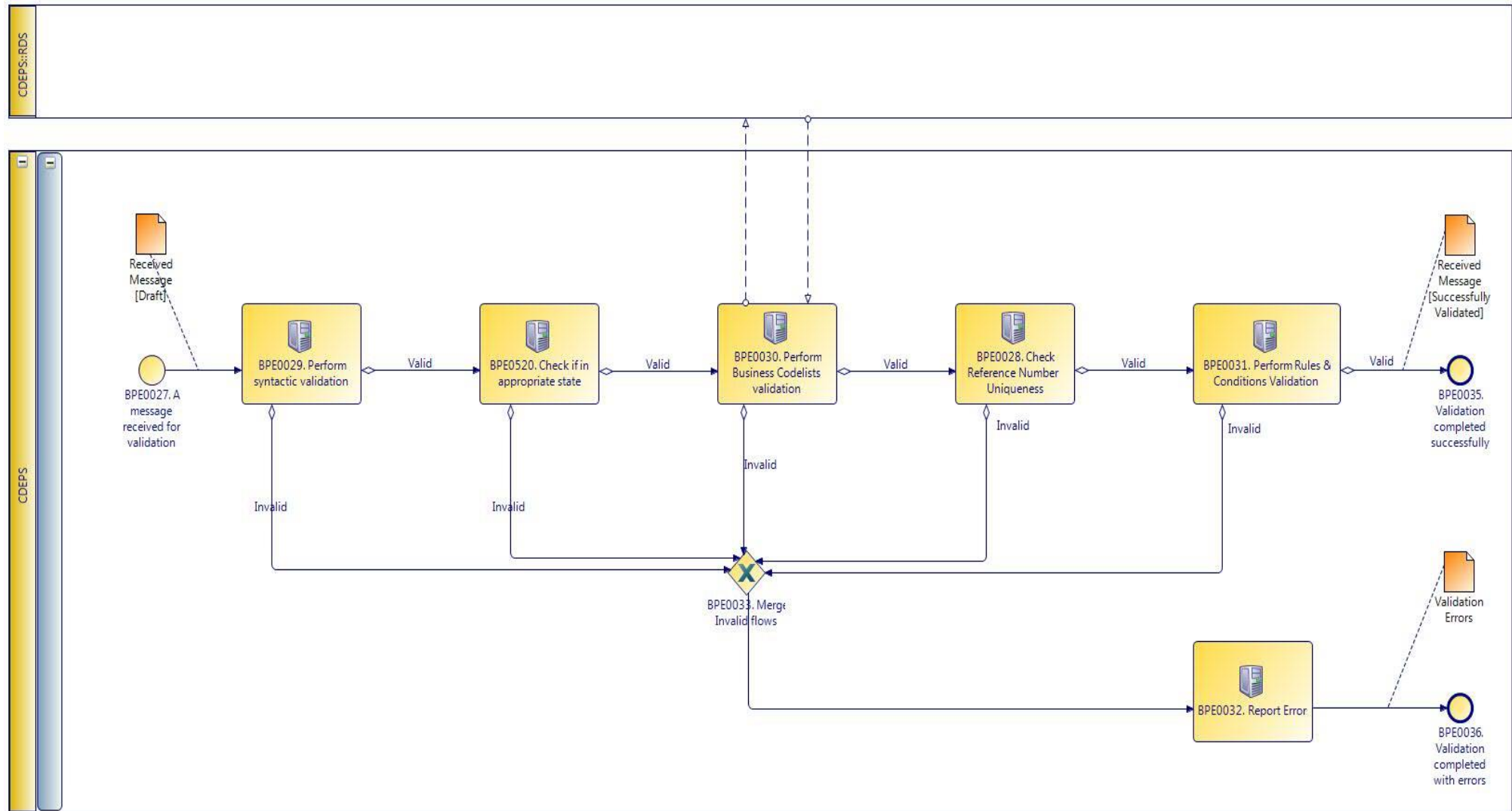

CARM Customs Declaration and Excise Documents Processing system (CDEPS)	REF: CDEPS_EXPORT_BPS
Business Process Specifications for EXPORT System	VER:410

1.2.6.1 Activities

The table below defines the 'Activities' of the 'BP0005. Validate' process.

Element Name	Description	Special Type
BPE0028. Check Reference Number Uniqueness	Check whether message reference numbers are unique in the system.	Service Task
↳ Business Rule 1	<i>Check Message Identification uniqueness</i>	
↳ Business Rule 74	<i>Check Local Reference Number (LRN) uniqueness</i>	
↳ Business Rule 75	<i>Check Movement Reference Number (MRN)uniqueness</i>	
↳ Business Rule 79	<i>Check Manifest reference number uniqueness</i>	
BPE0029. Perform syntactic validation	Check messages against the XSDs.	Service Task
↳ Business Rule 47	<i>Syntactic validation</i>	
BPE0030. Perform Business Codelists validation	Check the message business codelists.	Service Task
↳ Business Rule 50	<i>Business codelist validation against CDEPS:RDS</i>	
BPE0031. Perform Rules & Conditions Validation	Check the rules and conditions of the respective message.	Service Task
BPE0032. Report Errors	Report the identified errors from the validation process. The process terminates.	Service Task
BPE0520. Check if in appropriate state	Check whether the process for the particular entity (e.g. declaration/ application/ document) is on the appropriate state to process the received message. This check shall be performed based on the pertinent State Model of the system.	Service Task
↳ Business Rule 421	<i>Supplementary Declaration validation at Export</i>	
↳ Business Rule 448	<i>Check appropriate state for Export Declaration Amendment</i>	

CARM Customs Declaration and Excise Documents Processing system (CDEPS)	REF: CDEPS_EXPORT_BPS
Business Process Specifications for EXPORT System	VER:410

- ↳ **Business Rule** 449 *Check appropriate state Declaration Goods Presentation*
- ↳ **Business Rule** 468 *Guarantee Amendment*
- ↳ **Business Rule** 492 *Exit control results received at Export*
- ↳ **Business Rule** 493 *Export Declaration request at Export*

1.2.6.2 Event(s)

The table below defines the 'Event(s)' of the 'BP0005. Validate' process.

Element Name	Description	Special Type
BPE0027. A message or event notification from GUI is received for validation	Message input in the validation process.	Start
BPE0035. Validation completed successfully	The validation is completed successfully with no errors reported. The process terminates.	End
BPE0036. Validation completed with errors	The validation completed with errors. The process terminates.	End

1.2.6.3 Gateway(s)

The table below defines the 'Gateway(s)' of the 'BP0005. Validate' process.

Element Name	Description	Special Type
BPE0033. Merge Invalid Flows	Merge into exclusive event based gateway the invalid flows from all validation tasks.	Merge

CARM Customs Declaration and Excise Documents Processing system (CDEPS)	REF: CDEPS_EXPORT_BPS
Business Process Specifications for EXPORT System	VER:410

1.3. Process Group: Exit Summary Declaration arrival at Exit

1.3.1.BP0141. Process Arrival @ Actual Office of Exit

Business Process Description

The following table provides general information about the 'BP0141. Process Arrival @ Actual Office of Exit' process. The Business Process Diagram and the description of various business process elements are specified in the following paragraphs.

Description	A high level process describing the actions performed by the system in order to process the arrival at the Actual Office of Exit.
Precondition(s)	None
Trigger	The process is triggered by the reception of either an electronic arrival notification by the Trader or manually by the Customs Officer
Postcondition(s)	<ul style="list-style-type: none"> - Goods not Presented at Exit - Goods held for Storing - Goods Released for Immediate Leave

Business Process Diagram

The Business Process Diagram of 'BP0141. Process Arrival @ Actual Office of Exit' is shown below in BPMN notation. The definition of a process that might be used as sub-process by the 'BP0141. Process Arrival @ Actual Office of Exit' can be found in this document. Finally, Annex A of CDEPS-BPS-EXPORT provides some explanatory information about the used notation.

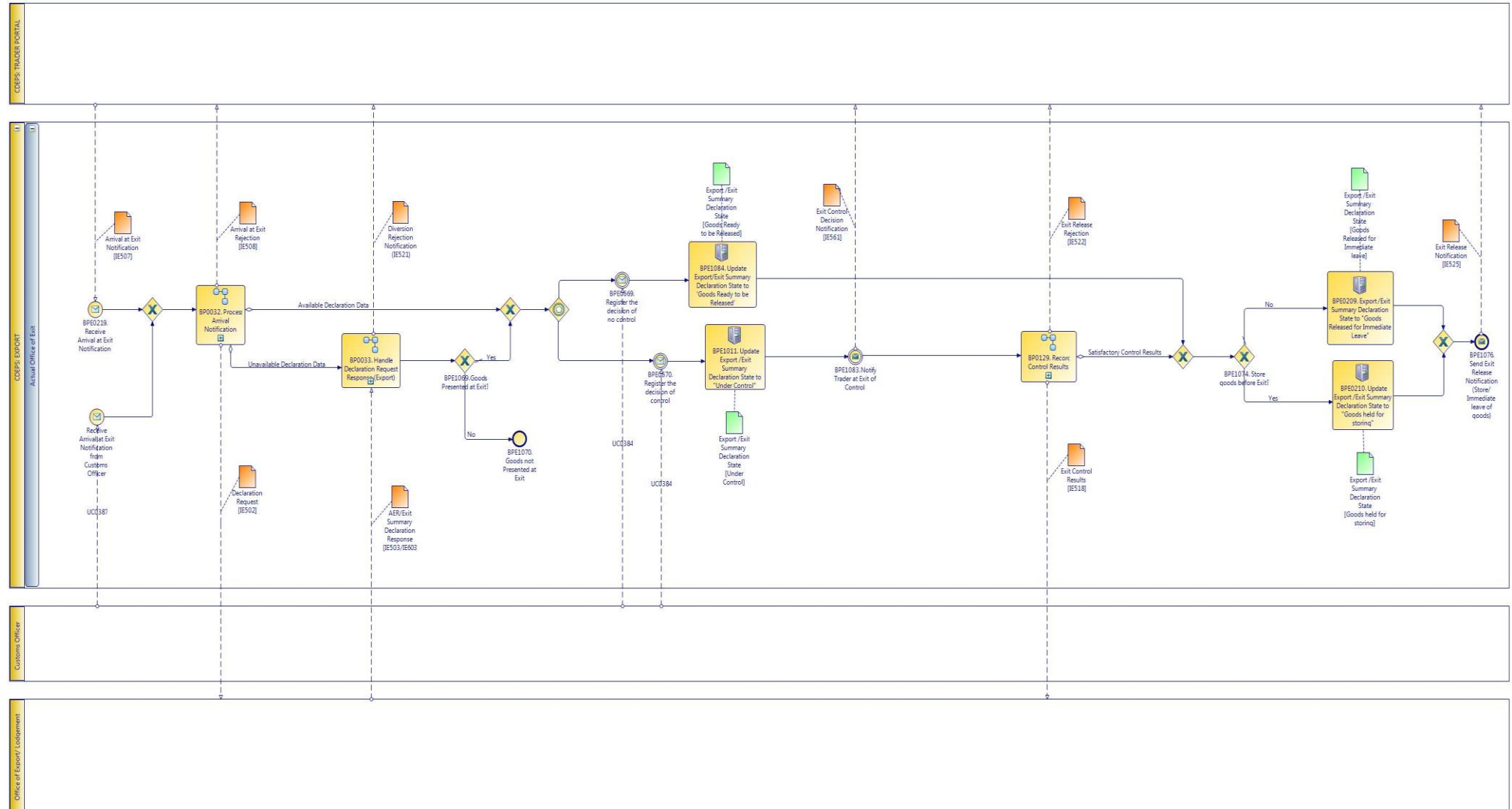

CARM Customs Declaration and Excise Documents Processing system (CDEPS)	REF: CDEPS_EXPORT_BPS
Business Process Specifications for EXPORT System	VER:410

1.3.1.1 Activities

The table below defines the 'Activities' of the 'BP0141. Process Arrival @ Actual Office of Exit' process.

Element Name	Description	Special Type
BPE0209. Update Export /Exit Summary Declaration State to "Goods Released for Immediate Leave"	The system updates the Export /Exit Summary Declaration State to "Goods released for immediate leave".	
BPE0210. Update Export /Exit Summary Declaration State to "Goods held for storing"	The system updates the Export /Exit Summary Declaration State to "Goods held for storing".	
BPE1011. Update Export /Exit Summary Declaration State to "Under Control"	The system updates the Export /Exit Summary Declaration State to "Under Control" upon the customs officer's decision to control.	Service Task

1.3.1.2 Event(s)

The table below defines the 'Event(s)' of the 'BP0141. Process Arrival @ Actual Office of Exit' process.

Element Name	Description	Special Type
BPE0219. Receive Arrival at Exit Notification	Office of Exit receives an arrival notification from the premises of the Trader at Exit (Carrier)	Start
BPE0669. Register the decision of no control	The Customs Officer at Office of Exit registers his decision no to control the goods.	Intermediate
BPE0670. Register the decision of control	The Customs Officer at Office of Exit registers his decision to control the goods.	Intermediate
BPE1070. Goods not Presented at Exit	The Goods are not presented at Exit and the AER/EXS is rejected. The process ends.	End

CARM Customs Declaration and Excise Documents Processing system (CDEPS)	REF: CDEPS_EXPORT_BPS
Business Process Specifications for EXPORT System	VER:410

BPE1076. Send Exit Release Notification (Store/Immediate leave of goods) The system sends an Exit Release Notification to Trader to communicate the release of the goods. End

BPE1083. Notify Trader at Exit of Control The system sends a notification to Trader at Exit to communicate the decision for control at Exit. Intermediate

1.3.1.3 Gateway(s)

The table below defines the 'Gateway(s)' of the 'BP0141. Process Arrival @ Actual Office of Exit' process.

Element Name	Description	Special Type
BPE1069. Goods Presented at Exit?	A decision point on the flow to decide whether the goods are presented at Exit based on the outgoing flow of the precedent process.	Decision
BPE1074. Store goods before Exit?	A decision gateway to decide whether the goods will be held for storing before exit or will be released for immediate leave.	Decision

CARM Customs Declaration and Excise Documents Processing system (CDEPS)	REF: CDEPS_EXPORT_BPS
Business Process Specifications for EXPORT System	VER:410

1.3.2.BP0032. Process Arrival Notification

Business Process Description

The following table provides general information about the 'BP0032. Process Arrival Notification' process. The Business Process Diagram and the description of various business process elements are specified in the following paragraphs.

Description	Goods are presented (IE507) to the Office of Exit (trader sends this message in the OfExt) either for immediately leaving the Community or for being stored in a warehouse prior to their exit.
Precondition(s)	Arrival Notification received
Trigger	The process starts when the Office of Exit has received the Arrival Notification.
Postcondition(s)	<ul style="list-style-type: none"> - Arrival Notification Rejected - Goods Presented at Exit - AER Requested

Business Process Diagram

The Business Process Diagram of 'BP0032. Process Arrival Notification' is shown below in BPMN notation. The definition of a process that might be used as sub-process by the 'BP0032. Process Arrival Notification' can be found in this document. Finally, Annex A of CDEPS-BPS-EXPORT provides some explanatory information about the used notation.

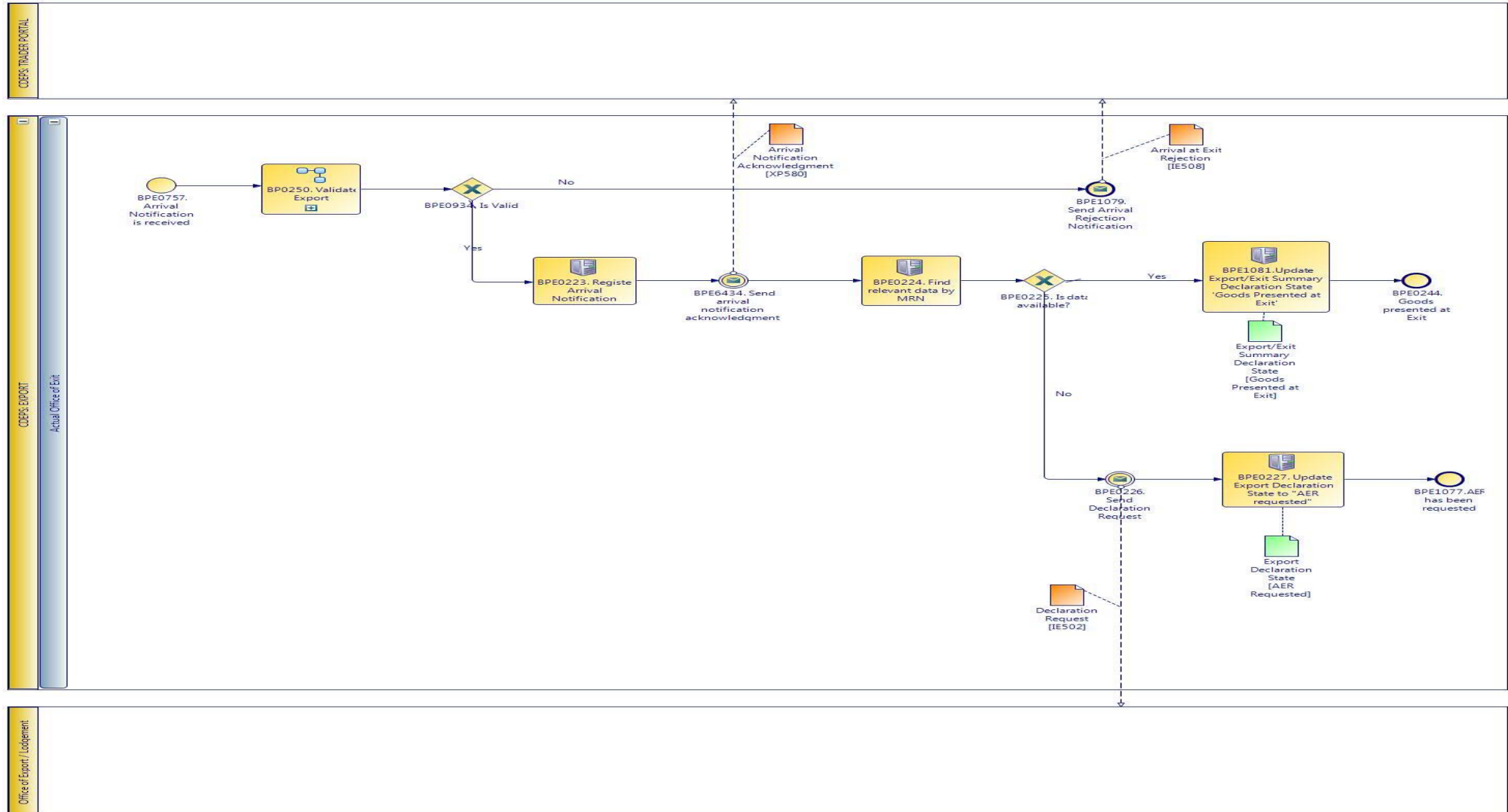

CARM Customs Declaration and Excise Documents Processing system (CDEPS)	REF: CDEPS_EXPORT_BPS
Business Process Specifications for EXPORT System	VER:410

1.3.2.1 Activities

The table below defines the 'Activities' of the 'BP0032. Process Arrival Notification' process.

Element Name	Description	Special Type
BPE0223. Register Arrival Notification	Validation is successful, arrival notification is registered	Service Task
BPE0224. Find relevant data by MRN	Query database to find relevant data by MRN	Service Task
BPE0227. Update Export Declaration State to "AER requested"	The system updates the Export Declaration State to "AER requested"	Service Task
BPE1081. Update Export/Exit Summary Declaration State to 'Goods Presented at Exit'	The system updates the Export/Exit Summary Declaration State to 'Goods Presented at Exit'	Service Task

1.3.2.2 Event(s)

The table below defines the 'Event(s)' of the 'BP0032. Process Arrival Notification' process.

Element Name	Description	Special Type
BPE0226. Send Declaration Request	Data not found, declaration request is sent to the Office of Export	Intermediate
BPE0244. Goods presented at Exit	Final state signaling that goods presented at Exit	End
BPE0757. Arrival Notification is received	The Arrival Notification is received at Actual Office of Exit.	Start
BPE1077. AER has been requested	The AER has been requested from the Office of Export and the process terminates.	End
BPE1079. Send Arrival Rejection Notification	The Arrival notification failed the validations and the Trader is notified about the rejection. End	

CARM Customs Declaration and Excise Documents Processing system (CDEPS)	REF: CDEPS_EXPORT_BPS
Business Process Specifications for EXPORT System	VER:410

BPE6434. Send arrival notification acknowledgment	Send arrival notification acknowledgment	Intermediate
--	--	--------------

1.3.2.3 Gateway(s)

The table below defines the 'Gateway(s)' of the 'BP0032. Process Arrival Notification' process.

Element Name	Description	Special Type
BPE0225. Is data available?	Check if relevant Export data is found based on the MRN provided	Decision
↳ Business Rule 62	<i>Locate movement in the OoExt</i>	
BPE0934. Is Valid?	A decision point in the process to navigate the flow based on the message validation result.	Decision
↳ Business Rule 638	<i>Import declaration type 'X' cannot be cancelled</i>	
↳ Business Rule 646	<i>Guarantees during the registration of Import declaration type 'X'</i>	
↳ Business Rule 80	<i>Valid Message</i>	

CARM Customs Declaration and Excise Documents Processing system (CDEPS)	REF: CDEPS_EXPORT_BPS
Business Process Specifications for EXPORT System	VER:410

1.3.3.BP0250. Validate Export

Business Process Description

The following table provides general information about the 'BP0250. Validate Export' process. The Business Process Diagram and the description of various business process elements are specified in the following paragraphs.

Description	Reusable subprocess that performs the message validation tasks for Export Regime.
Precondition(s)	None
Trigger	The process is triggered when an electronic message is received for validation.
Postcondition(s)	The validation is either completed successfully or with errors reported

Business Process Diagram

The Business Process Diagram of 'BP0250. Validate Export' is shown below in BPMN notation. The definition of a process that might be used as sub-process by the 'BP0250. Validate Export' can be found in this document. Finally, Annex A of CDEPS-BPS-EXPORT provides some explanatory information about the used notation.

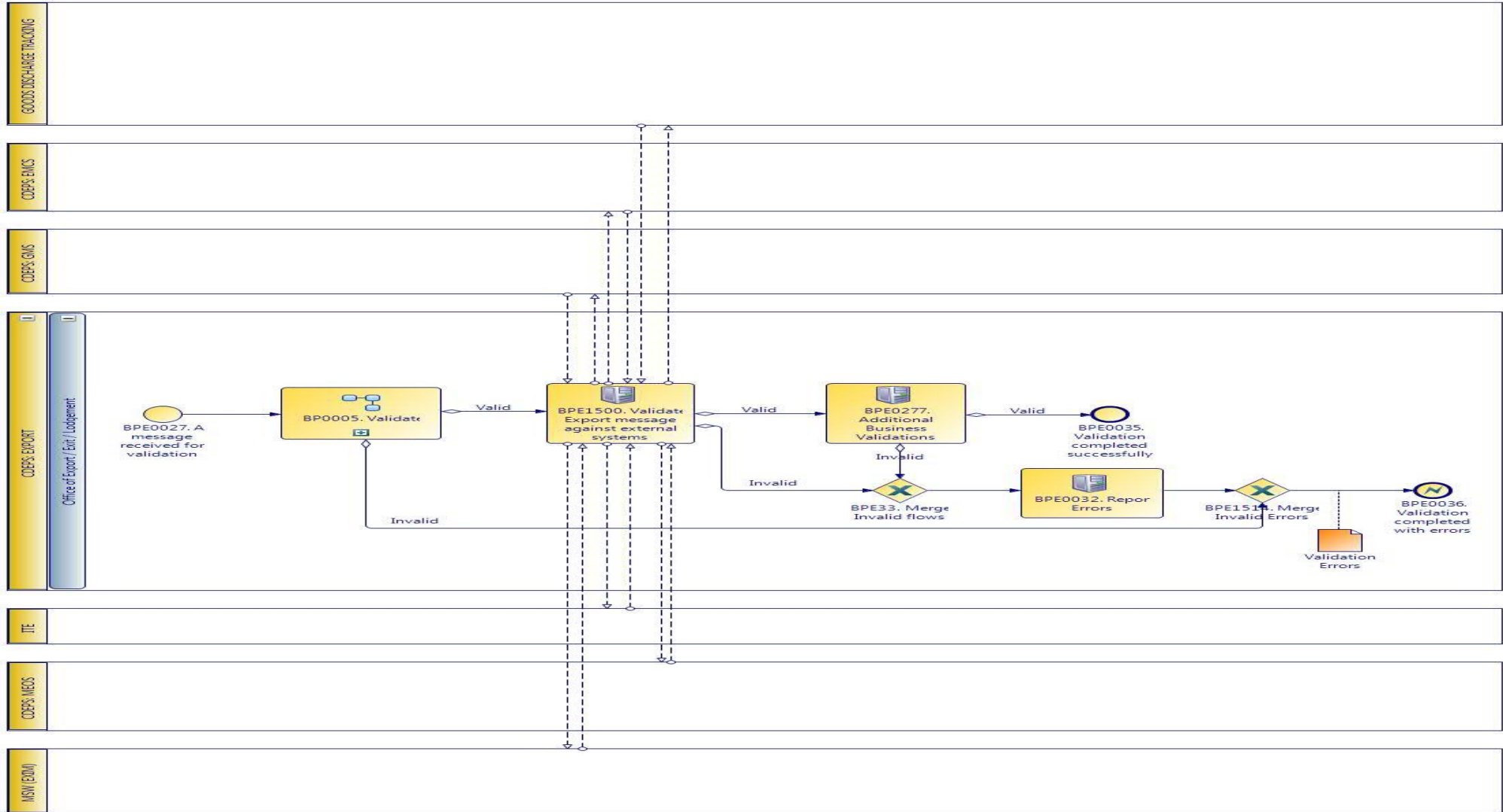

CARM Customs Declaration and Excise Documents Processing system (CDEPS)	REF: CDEPS_EXPORT_BPS
Business Process Specifications for EXPORT System	VER:410

1.3.3.1 Activities

The table below defines the 'Activities' of the 'BP0250. Validate Export' process.

Element Name	Description	Special Type
BPE0032. Report Errors	Report the identified errors from the validation process. The process terminates.	Service Task
BPE0277. Additional Business Validations for Export	The system performs any additional business validations specific to Export System.	Service Task
↳ Business Rule 19	Trader amending data same as Person lodging the declaration	
↳ Business Rule 21	Reject ENS/EXS amendment if ENS/EXS is not in appropriate state	
↳ Business Rule 245	Validate Personal ID	
↳ Business Rule 39	Cancellation Constraint	
↳ Business Rule 520	Import/ Export allowed guarantee types	
↳ Business Rule 70	EXS exists at the Office of Exit	
↳ Business Rule 71	Manifest number in IE547 and IE590	
BPE1500. Validate Export message against external systems	The system performs message validations against external systems.	Service Task
↳ Business Rule 101	Validate Economic Operator against MEOS	
↳ Business Rule 422	Validation of NCTS notifications	
↳ Business Rule 425	Goods Discharge required	
↳ Business Rule 439	Validate against GMS for integrity check	
↳ Business Rule 440	Validate Economic Operator's TIN against MEOS	
↳ Business Rule 494	Orchestrate validation of Export message against external systems	
↳ Business Rule 508	Validation of Export licenses with EXIM	

CARM Customs Declaration and Excise Documents Processing system (CDEPS)	REF: CDEPS_EXPORT_BPS
Business Process Specifications for EXPORT System	VER:410
↳ Business Rule 509	Check Export authorizations with MEOS
↳ Business Rule 51	Validate declared Combined Nomenclature in Declaration against ITE.
↳ Business Rule 510	Check Export authorizations for representation with MEOS
↳ Business Rule 511	Check Evidence of Power of Attorney with MEOS
↳ Business Rule 521	Validate Export declaration against ITE (duty calculation).
↳ Business Rule 522	Validate Export declaration data against Goods Discharge Tracking system
↳ Business Rule 527	Validate Export Declaration data against Excise system

1.3.3.2 Event(s)

The table below defines the 'Event(s)' of the 'BP0250. Validate Export' process.

Element Name	Description	Special Type
BPE0027. A message or event notification from GUI is received for validation	Message input in the validation process.	Start
BPE0035. Validation completed successfully	The validation is completed successfully with no errors reported. The process terminates.	End
BPE0036. Validation completed with errors	The validation completed with errors. The process terminates.	End

1.3.3.3 Gateway(s)

The table below defines the 'Gateway(s)' of the 'BP0250. Validate Export' process.

Element Name	Description	Special Type
BPE1514. Merge Invalid Errors	Combines exclusively either the negative outcome of generic validate process (BP0005. Validate) which reports errors or the errors from the extra checks for the specific system.	Merge

CARM Customs Declaration and Excise Documents Processing system (CDEPS)	REF: CDEPS_EXPORT_BPS
Business Process Specifications for EXPORT System	VER:410

1.3.4.BP0033. Handle Declaration Request Response (Export)

Business Process Description

The following table provides general information about the 'BP0033. Handle Declaration Request Response (Export)' process. The Business Process Diagram and the description of various business process elements are specified in the following paragraphs.

Description	The Office of Exit receives the export or exit summary declaration response from the Country of Export or Lodgement.
Precondition(s)	- AER Requested
Trigger	The system receives the response to the declaration request
Postcondition(s)	- None - Diversion Rejected - Goods Presented at Exit

Business Process Diagram

The Business Process Diagram of 'BP0033. Handle Declaration Request Response (Export)' is shown below in BPMN notation. The definition of a process that might be used as sub-process by the 'BP0033. Handle Declaration Request Response (Export)' can be found in this document. Finally, Annex A of CDEPS-BPS-EXPORT provides some explanatory information about the used notation.

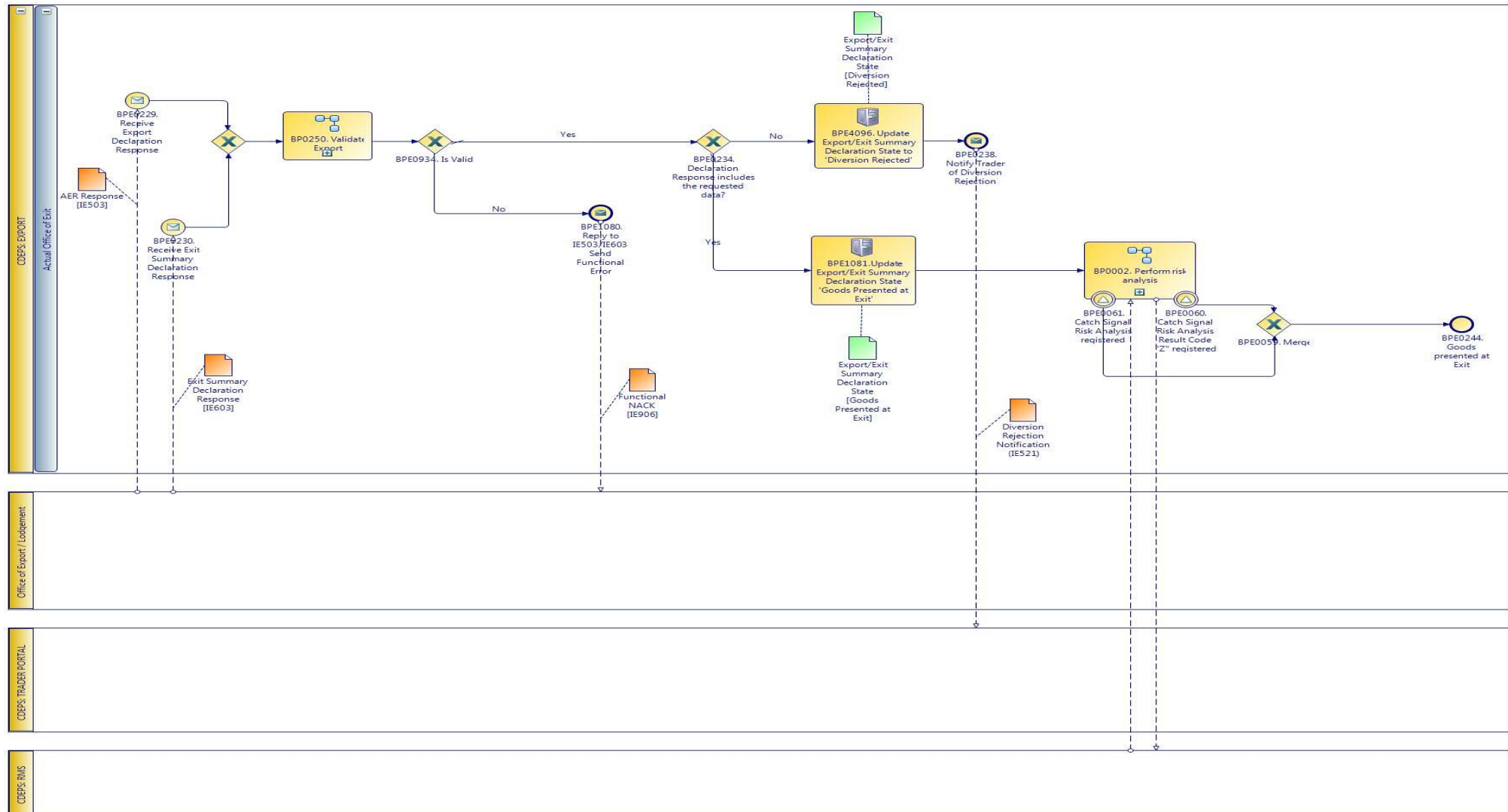

CARM Customs Declaration and Excise Documents Processing system (CDEPS)	REF: CDEPS_EXPORT_BPS
Business Process Specifications for EXPORT System	VER:410

1.3.4.1 Activities

The table below defines the 'Activities' of the 'BP0033. Handle Declaration Request Response (Export)' process.

Element Name	Description	Special Type
BPE1081. Update Export/Exit Summary Declaration State to 'Goods Presented at Exit'	The system updates the Export/Exit Summary Declaration State to 'Goods Presented at Exit'	Service Task
BPE4096. Update Export/Exit Summary Declaration State to 'Diversion Rejected'	The system updates the state of the declaration to 'Diversion Rejected'	Service Task

1.3.4.2 Event(s)

The table below defines the 'Event(s)' of the 'BP0033. Handle Declaration Request Response (Export)' process.

Element Name	Description	Special Type
BPE0229. Receive Export Declaration Response	In case data relates to Export declaration (it can be positive or negative response)	Start
BPE0230. Receive Exit Summary Declaration Response	In case data relates to Exit Summary Declaration (it can be positive or negative response)	Start
BPE0238. Notify Trader of Diversion Rejection	Diversion rejection notification is sent to the Trader at Exit	End
BPE0244. Goods presented at Exit	Final state signaling that goods presented at Exit	End
BPE1080. Reply to IE503/IE603 : Send Functional Error	The Export/Exit Summary declaration response failed the validations and the Office of Export/Lodgement is notified accordingly.	End

CARM Customs Declaration and Excise Documents Processing system (CDEPS)	REF: CDEPS_EXPORT_BPS
Business Process Specifications for EXPORT System	VER:410

1.3.4.3 Gateway(s)

The table below defines the 'Gateway(s)' of the 'BP0033. Handle Declaration Request Response (Export)' process.

Element Name	Description	Special Type
BPE0059. Merge	Merge risk analysis completion signals	Merge
BPE0234. Declaration Response includes the requested data?	Check if Declaration Response includes the requested data and decide	Decision
↳ Business Rule 61	<i>Notify diversion to the OoExt</i>	
BPE0934. Is Valid?	A decision point in the process to navigate the flow based on the message validation result.	Decision
↳ Business Rule 638	<i>Import declaration type 'X' cannot be cancelled</i>	
↳ Business Rule 646	<i>Guarantees during the registration of Import declaration type 'X'</i>	
↳ Business Rule 80	<i>Valid Message</i>	

CARM Customs Declaration and Excise Documents Processing system (CDEPS)	REF: CDEPS_EXPORT_BPS
Business Process Specifications for EXPORT System	VER:410

1.3.5.BP0129. Record Control Results

Business Process Description

The following table provides general information about the 'BP0129. Record Control Results' process. The Business Process Diagram and the description of various business process elements are specified in the following paragraphs.

Description	The Custom Officer records the Control Results Control results of type 'A' (satisfactory or minor discrepancies): the system records that the goods are ready to be released. In case of minor discrepancies, the goods may also be ready to be released for exit. Control results of type 'B' (not satisfactory): The Office of Export is notified about the exit control results (IE518 reporting the detected discrepancies) and the goods may not be released for exit;
Precondition(s)	Control of goods is finalised
Trigger	The process is triggered when the Customs Officer selects to register the Exit Control Results
Postcondition(s)	- Goods Ready to be Released - Goods not Allowed to Exit

Business Process Diagram

The Business Process Diagram of 'BP0129. Record Control Results' is shown below in BPMN notation. The definition of a process that might be used as sub-process by the 'BP0129. Record Control Results' can be found in this document. Finally, Annex A of CDEPS-BPS-EXPORT provides some explanatory information about the used notation.

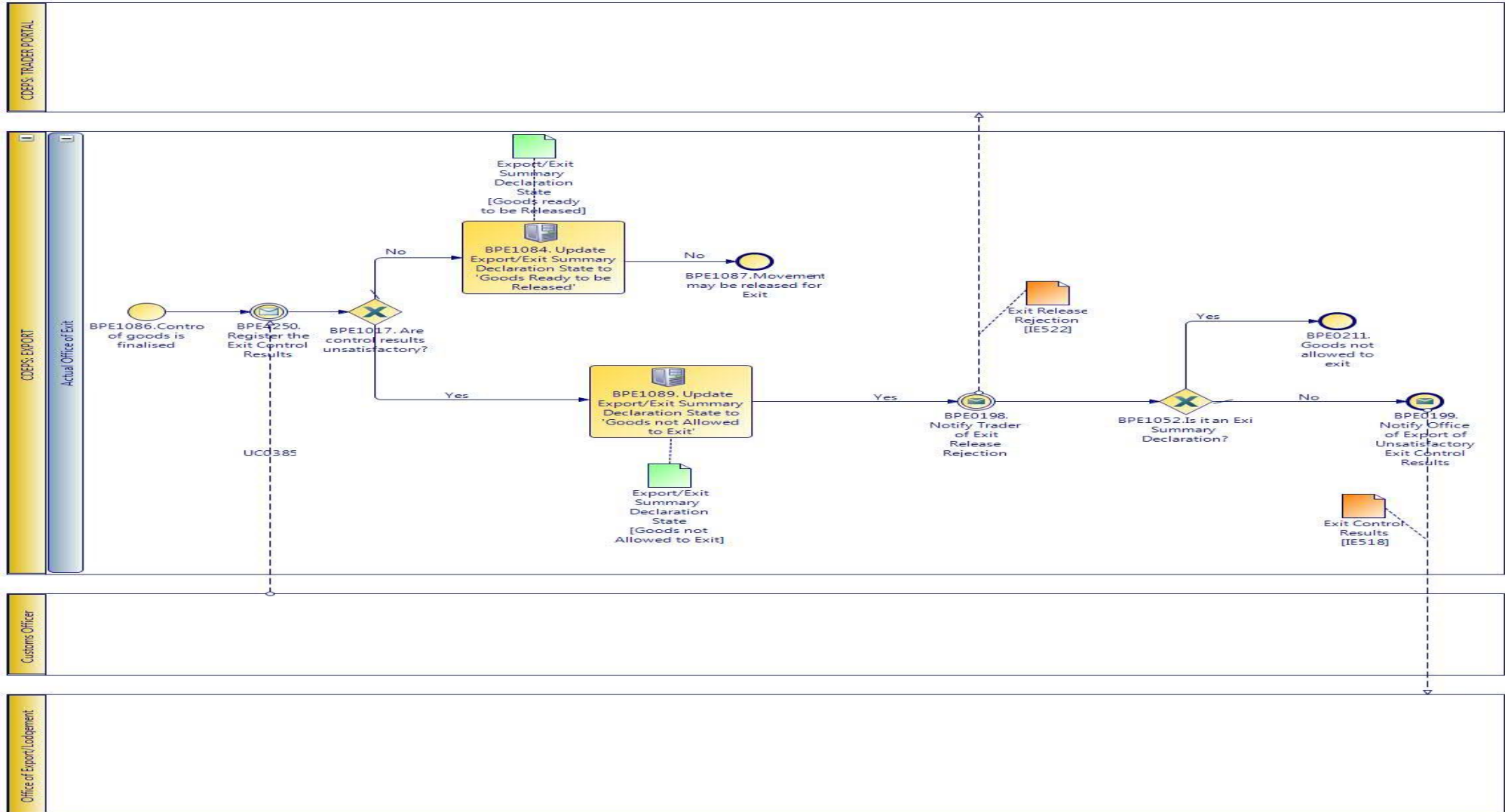

CARM Customs Declaration and Excise Documents Processing system (CDEPS)	REF: CDEPS_EXPORT_BPS
Business Process Specifications for EXPORT System	VER:410

1.3.5.1 Activities

The table below defines the 'Activities' of the 'BP0129. Record Control Results' process.

Element Name	Description	Special Type
BPE1089. Update Export/Exit Summary Declaration State to 'Goods not Allowed to Exit'	The control results are satisfactory and the system updates the state of the declaration to 'Goods not Allowed to Exit'.	Service Task

1.3.5.2 Event(s)

The table below defines the 'Event(s)' of the 'BP0129. Record Control Results' process.

Element Name	Description	Special Type
BPE0198. Notify Trader of Exit Release Rejection	Control results are not satisfactory, Trader at Exit is notified that goods are stopped at exit	Intermediate
BPE0199. Notify Office of Export of Unsatisfactory Exit Control Results	Office of Export is notified of unsatisfactory exit control results	End
BPE0211. Goods not allowed to exit	Control results are not satisfactory in the exit process, goods are stopped	End
BPE1086. Control of goods is finalised	The goods have been controlled.	Start
BPE1087. Movement may be released for Exit	The control results are satisfactory and the movement may be released for Exit. The process terminates.	End
BPE4250. Register the Exit Control Results	The Customs Officer registers the exit control results to the system	Intermediate

CARM Customs Declaration and Excise Documents Processing system (CDEPS)	REF: CDEPS_EXPORT_BPS
Business Process Specifications for EXPORT System	VER:410

1.3.5.3 Gateway(s)

The table below defines the 'Gateway(s)' of the 'BP0129. Record Control Results' process.

Element Name	Description	Special Type
BPE1017. Are control results unsatisfactory?	A decision point in the process to navigate the flow based on whether the control results are satisfactory or not.	Decision
BPE1052. Is it an Exit Summary Declaration?	A decision point on the process to navigate the flow based on the type of the declaration (Export or Exit Summary).	Decision

CARM Customs Declaration and Excise Documents Processing system (CDEPS)	REF: CDEPS_EXPORT_BPS
Business Process Specifications for EXPORT System	VER:410

1.3.6.BP0005. Validate

Business Process Description

The following table provides general information about the 'BP0005. Validate' process. The Business Process Diagram and the description of various business process elements are specified in the following paragraphs.

Description	Reusable subprocess that performs the message validation tasks
Precondition(s)	None
Trigger	The process is triggered when an electronic message is received for validation.
Postcondition(s)	

Business Process Diagram

The Business Process Diagram of 'BP0005. Validate' is shown below in BPMN notation. The definition of a process that might be used as sub-process by the 'BP0005. Validate' can be found in this document. Finally, Annex A of CDEPS-BPS-EXPORT provides some explanatory information about the used notation.

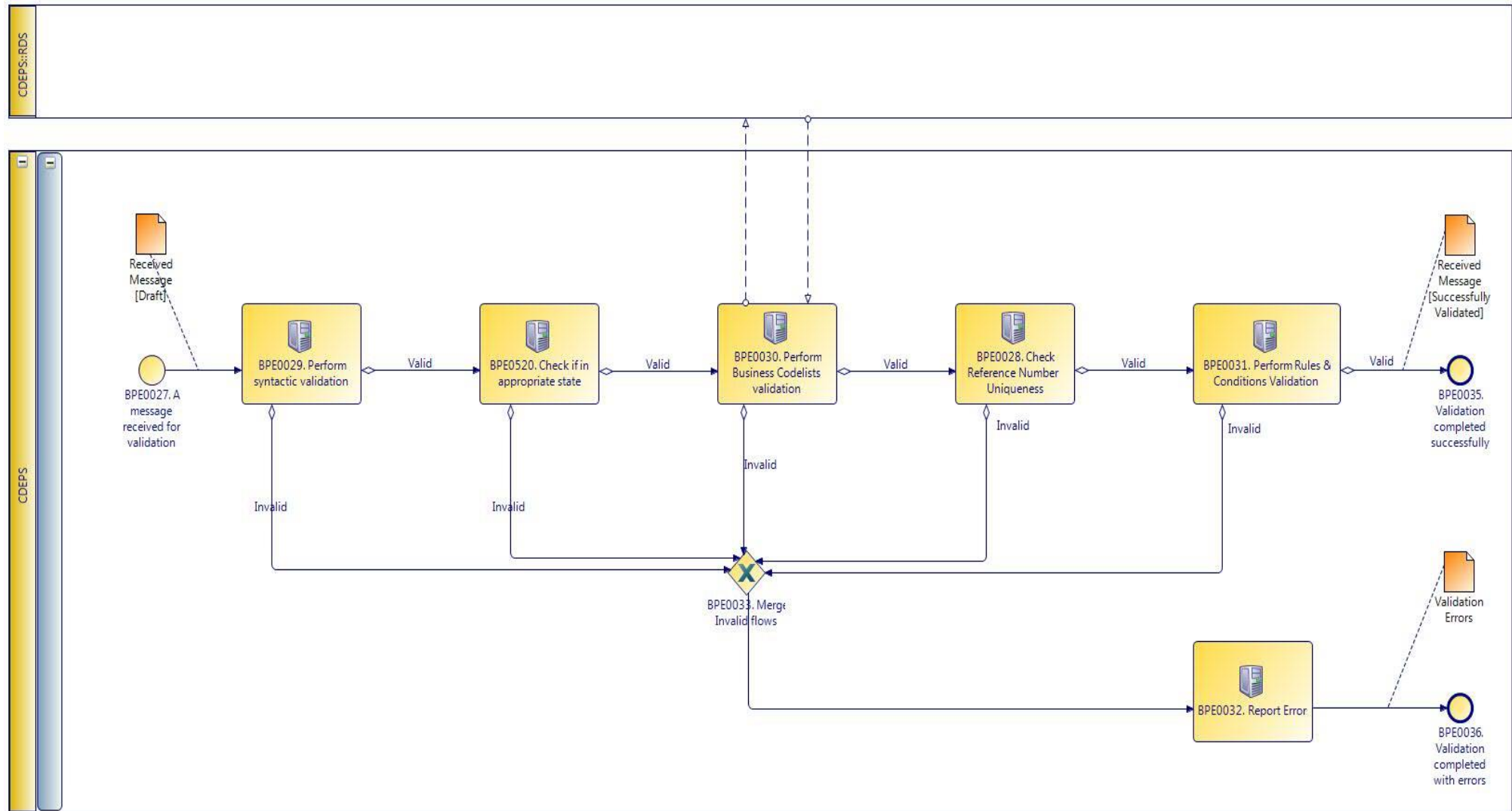

CARM Customs Declaration and Excise Documents Processing system (CDEPS)	REF: CDEPS_EXPORT_BPS
Business Process Specifications for EXPORT System	VER:410

1.3.6.1 Activities

The table below defines the 'Activities' of the 'BP0005. Validate' process.

Element Name	Description	Special Type
BPE0028. Check Reference Number Uniqueness	Check whether message reference numbers are unique in the system.	Service Task
↳ Business Rule 1	<i>Check Message Identification uniqueness</i>	
↳ Business Rule 74	<i>Check Local Reference Number (LRN) uniqueness</i>	
↳ Business Rule 75	<i>Check Movement Reference Number (MRN)uniqueness</i>	
↳ Business Rule 79	<i>Check Manifest reference number uniqueness</i>	
BPE0029. Perform syntactic validation	Check messages against the XSDs.	Service Task
↳ Business Rule 47	<i>Syntactic validation</i>	
BPE0030. Perform Business Codelists validation	Check the message business codelists.	Service Task
↳ Business Rule 50	<i>Business codelist validation against CDEPS:RDS</i>	
BPE0031. Perform Rules & Conditions Validation	Check the rules and conditions of the respective message.	Service Task
BPE0032. Report Errors	Report the identified errors from the validation process. The process terminates.	Service Task
BPE0520. Check if in appropriate state	Check whether the process for the particular entity (e.g. declaration/ application/ document) is on the appropriate state to process the received message. This check shall be performed based on the pertinent State Model of the system.	Service Task
↳ Business Rule 421	<i>Supplementary Declaration validation at Export</i>	
↳ Business Rule 448	<i>Check appropriate state for Export Declaration Amendment</i>	

CARM Customs Declaration and Excise Documents Processing system (CDEPS)	REF: CDEPS_EXPORT_BPS
Business Process Specifications for EXPORT System	VER:410

- ↳ **Business Rule** 449 *Check appropriate state Declaration Goods Presentation*
- ↳ **Business Rule** 468 *Guarantee Amendment*
- ↳ **Business Rule** 492 *Exit control results received at Export*
- ↳ **Business Rule** 493 *Export Declaration request at Export*

1.3.6.2 Event(s)

The table below defines the 'Event(s)' of the 'BP0005. Validate' process.

Element Name	Description	Special Type
BPE0027. A message or event notification from GUI is received for validation	Message input in the validation process.	Start
BPE0035. Validation completed successfully	The validation is completed successfully with no errors reported. The process terminates.	End
BPE0036. Validation completed with errors	The validation completed with errors. The process terminates.	End

1.3.6.3 Gateway(s)

The table below defines the 'Gateway(s)' of the 'BP0005. Validate' process.

Element Name	Description	Special Type
BPE0033. Merge Invalid Flows	Merge into exclusive event based gateway the invalid flows from all validation tasks.	Merge

CARM Customs Declaration and Excise Documents Processing system (CDEPS)	REF: CDEPS_EXPORT_BPS
Business Process Specifications for EXPORT System	VER:410

1.4. Process Group: Exit Summary Declaration arrival at Lodgement

1.4.1.BP0161. Process Arrival @ Office of Lodgement

Business Process Description

The following table provides general information about the 'BP0161. Process Arrival @ Office of Lodgement' process. The Business Process Diagram and the description of various business process elements are specified in the following paragraphs.

Description	A master process that processes the arrival at the Office of Lodgement
Precondition(s)	- None - Accepted
Trigger	The process is triggered by the reception of a Declaration Request
Postcondition(s)	None

Business Process Diagram

The Business Process Diagram of 'BP0161. Process Arrival @ Office of Lodgement' is shown below in BPMN notation. The definition of a process that might be used as sub-process by the 'BP0161. Process Arrival @ Office of Lodgement' can be found in this document. Finally, Annex A of CDEPS-BPS-EXPORT provides some explanatory information about the used notation.

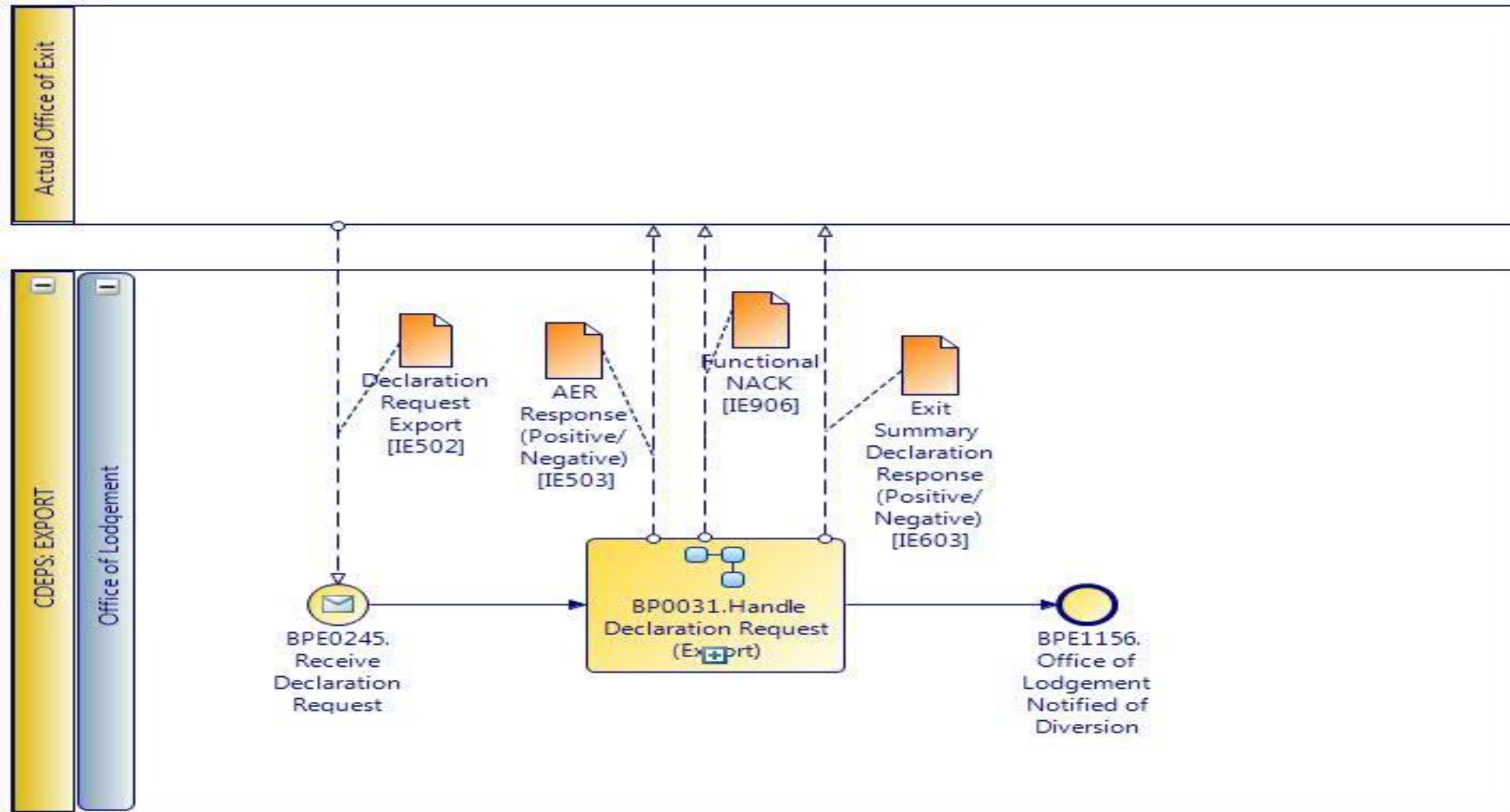

CARM Customs Declaration and Excise Documents Processing system (CDEPS)	REF: CDEPS_EXPORT_BPS
Business Process Specifications for EXPORT System	VER:410

1.4.1.1 Event(s)

The table below defines the 'Event(s)' of the 'BP0161. Process Arrival @ Office of Lodgement' process.

Element Name	Description	Special Type
BPE0245. Receive Declaration Request	Receive an export declaration request from the Office of Exit	Start
BPE1156. Office of Lodgement Notified of Diversion	The Office of Lodgement is notified of Diversion and the process terminates	End

CARM Customs Declaration and Excise Documents Processing system (CDEPS)	REF: CDEPS_EXPORT_BPS
Business Process Specifications for EXPORT System	VER:410

1.4.2.BP0031. Handle Declaration Request (Export)

Business Process Description

The following table provides general information about the 'BP0031. Handle Declaration Request (Export)' process. The Business Process Diagram and the description of various business process elements are specified in the following paragraphs.

Description	This process is used for export and exit summary declarations to request and retrieve data (if available) on an EXPORT Operation for which data is not available in the Member State of the Actual Office of Exit (international diversion or other exceptional cases).
Precondition(s)	Declaration request is received
Trigger	The process is triggered by the declaration request (IE502) from the Office of Exit
Postcondition(s)	None

Business Process Diagram

The Business Process Diagram of 'BP0031. Handle Declaration Request (Export)' is shown below in BPMN notation. The definition of a process that might be used as sub-process by the 'BP0031. Handle Declaration Request (Export)' can be found in this document. Finally, Annex A of CDEPS-BPS-EXPORT provides some explanatory information about the used notation.

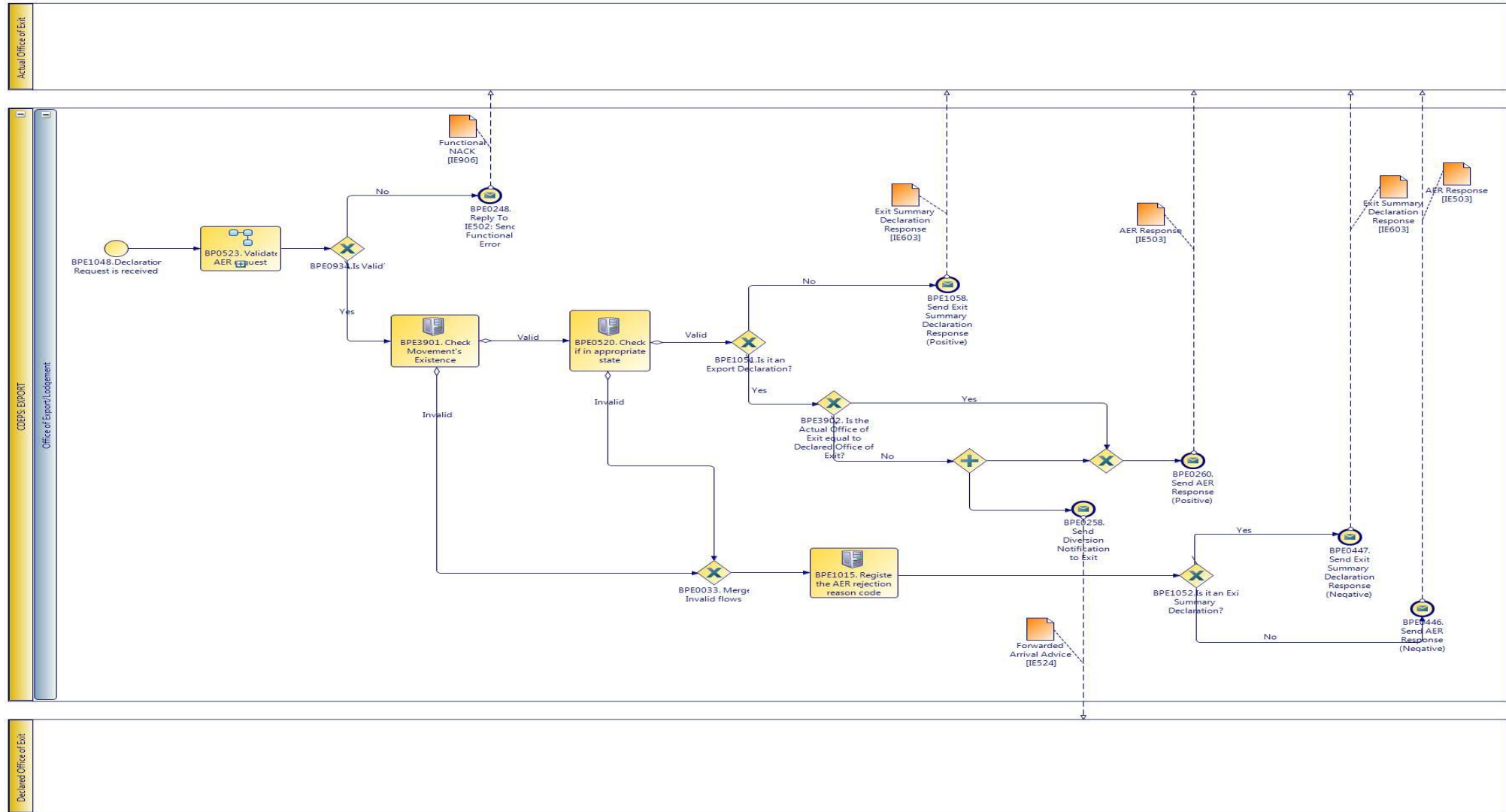

CARM Customs Declaration and Excise Documents Processing system (CDEPS)	REF: CDEPS_EXPORT_BPS
Business Process Specifications for EXPORT System	VER:410

1.4.2.1 Activities

The table below defines the 'Activities' of the 'BP0031. Handle Declaration Request (Export)' process.

Element Name	Description	Special Type
BPE0520. Check if in appropriate state	Check whether the process for the particular entity (e.g. declaration/ application/ document) is on the appropriate state to process the received message. This check shall be performed based on the pertinent State Model of the system.	Service Task
↳ Business Rule 421	<i>Supplementary Declaration validation at Export</i>	
↳ Business Rule 448	<i>Check appropriate state for Export Declaration Amendment</i>	
↳ Business Rule 449	<i>Check appropriate state Declaration Goods Presentation</i>	
↳ Business Rule 468	<i>Guarantee Amendment</i>	
↳ Business Rule 492	<i>Exit control results received at Export</i>	
↳ Business Rule 493	<i>Export Declaration request at Export</i>	
BPE1015. Register the Declaration Request rejection reason code	The system registers the Declaration Request rejection reason code based on the results of the checks performed previously	Service Task
BPE1051. Is it an Export Declaration?	A decision point on the process to navigate the flow based on the type of the declaration (Export or Exit Summary).	
BPE3901. Check Movement's Existence	The system checks whether the movement exists	Service Task

1.4.2.2 Event(s)

The table below defines the 'Event(s)' of the 'BP0031. Handle Declaration Request (Export)' process.

Element Name	Description	Special Type
BPE0248. Reply To IE502: Send Functional Error	The system sends a Functional Error message back to the Office of Exit as a reply to the invalid Declaration Request received.	End
BPE0258. Send Diversion Notification to Exit	Declaration response is positive, notify diversion to the declared OoExt	End

CARM Customs Declaration and Excise Documents Processing system (CDEPS)	REF: CDEPS_EXPORT_BPS
Business Process Specifications for EXPORT System	VER:410

BPE0260. Send AER Response (Positive)	A positive AER response is sent to the Office of Exit in case the MRN is known and the export declaration is in the appropriate state.	End
BPE0446. Send AER Response (Negative)	A negative AER response is sent to the Office of Exit in case either the MRN is unknown or the the MRN is known but the export declaration is not in an appropriate state.	End
BPE0447. Send Exit Summary Declaration Response (Negative)	A negative Exit Summary Declaration response is sent to the Office of Exit in case either the MRN is unknown or the the MRN is known but the summary declaration is not in an appropriate state.	End
BPE1048. Declaration Request is received	A Declaration Request from Office of Exit is received	Start
BPE1058. Send Exit Summary Declaration Response (Positive)	A positive Exit Summary Declaration response is sent to the Office of Exit in case the MRN is known and the summary declaration is in the appropriate state.	End

1.4.2.3 Gateway(s)

The table below defines the 'Gateway(s)' of the 'BP0031. Handle Declaration Request (Export)' process.

Element Name	Description	Special Type
BPE0033. Merge Invalid Flows	Merge into exclusive event based gateway the invalid flows from all validation tasks.	Merge
BPE0246. Is Declaration Request valid?	IF BP5.result = "Validation completed successfully" THEN TRUE ELSE FALSE	Decision
BPE0934. Is Valid?	A decision point in the process to navigate the flow based on the message validation result.	Decision
↳ Business Rule	638 <i>Import declaration type 'X' cannot be cancelled</i>	
↳ Business Rule	646 <i>Guarantees during the registration of Import declaration type 'X'</i>	
↳ Business Rule	80 <i>Valid Message</i>	
BPE1052. Is it an Exit Summary Declaration?	A decision point on the process to navigate the flow based on the type of the declaration (Export or Exit Summary).	Decision

CARM Customs Declaration and Excise Documents Processing system (CDEPS)	REF: CDEPS_EXPORT_BPS
Business Process Specifications for EXPORT System	VER:410

BPE3902. Is the Actual Office of Exit equal to Declared Office of Exit? A decision point in the process to navigate the flow based on whether the IActual Office Decision of Exit is equal to Declared Office of Exit

CARM Customs Declaration and Excise Documents Processing system (CDEPS)	REF: CDEPS_EXPORT_BPS
Business Process Specifications for EXPORT System	VER:410

1.4.3.BP0523. Validate Declaration Request

Business Process Description

The following table provides general information about the 'BP0523. Validate Declaration Request' process. The Business Process Diagram and the description of various business process elements are specified in the following paragraphs.

Description	Reusable subprocess that describes the tasks performed by the system in order to validate the Declaration request received from the Office of Exit
Precondition(s)	None
Trigger	AER request received for validation
Postcondition(s)	- Validation completed successfully - Validation completed with errors

Business Process Diagram

The Business Process Diagram of 'BP0523. Validate Declaration Request' is shown below in BPMN notation. The definition of a process that might be used as sub-process by the 'BP0523. Validate Declaration Request' can be found in this document. Finally, Annex A of CDEPS-BPS-EXPORT provides some explanatory information about the used notation.

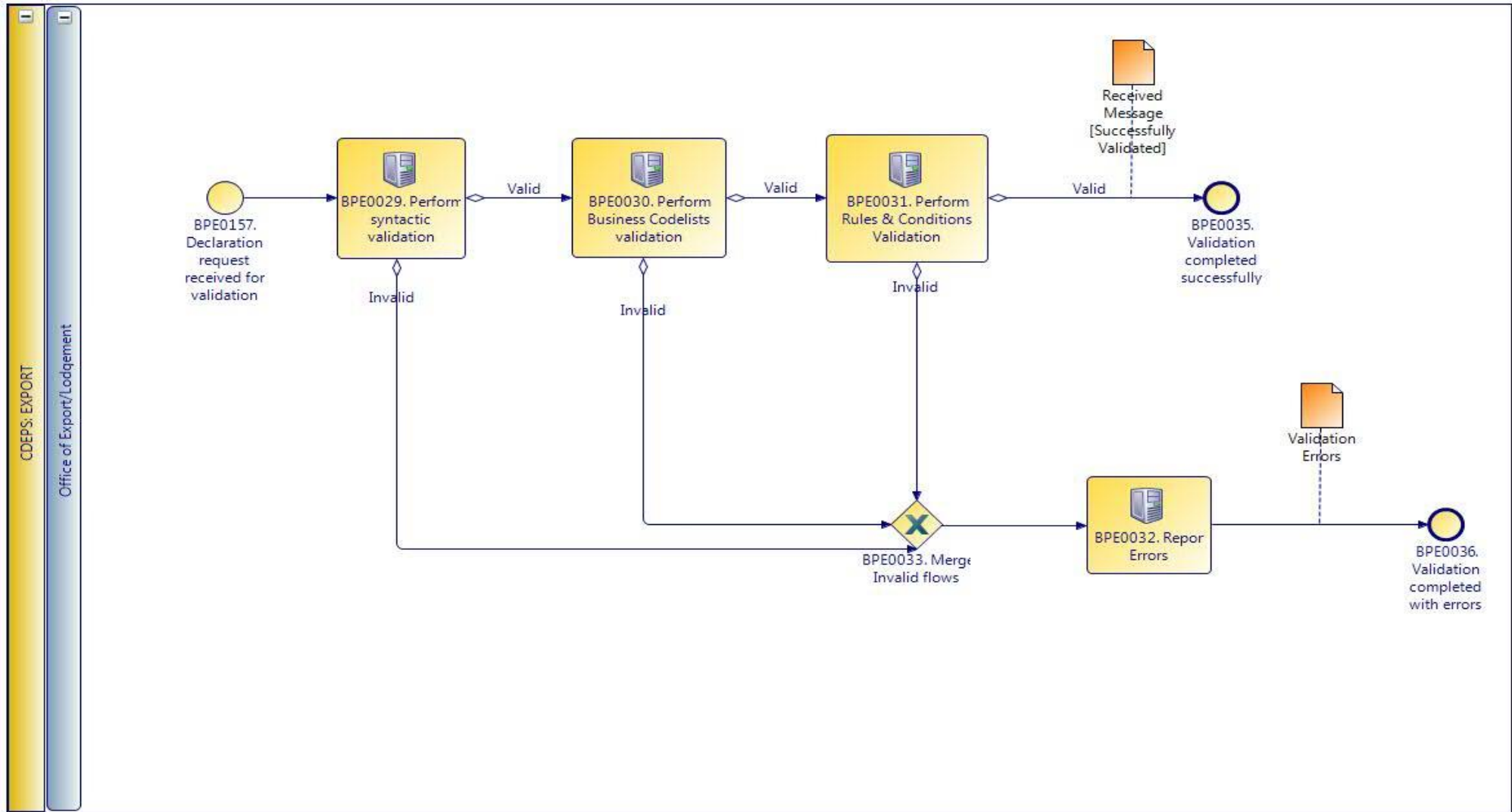

CARM Customs Declaration and Excise Documents Processing system (CDEPS)	REF: CDEPS_EXPORT_BPS
Business Process Specifications for EXPORT System	VER:410

1.4.3.1 Activities

The table below defines the 'Activities' of the 'BP0523. Validate Declaration Request' process.

Element Name	Description	Special Type
BPE0029. Perform syntactic validation	Check messages against the XSDs.	Service Task
↳ Business Rule 47	<i>Syntactic validation</i>	
BPE0030. Perform Business Codelists validation	Check the message business codelists.	Service Task
↳ Business Rule 50	<i>Business codelist validation against CDEPS:RDS</i>	
BPE0031. Perform Rules & Conditions Validation	Check the rules and conditions of the respective message.	Service Task
BPE0032. Report Errors	Report the identified errors from the validation process. The process terminates.	Service Task

1.4.3.2 Event(s)

The table below defines the 'Event(s)' of the 'BP0523. Validate Declaration Request' process.

Element Name	Description	Special Type
BPE0035. Validation completed successfully	The validation is completed successfully with no errors reported. The process terminates.	End
BPE0036. Validation completed with errors	The validation completed with errors. The process terminates.	End
BPE0157. Declaration request received for validation	Declaration request received for validation	Start

CARM Customs Declaration and Excise Documents Processing system (CDEPS)	REF: CDEPS_EXPORT_BPS
Business Process Specifications for EXPORT System	VER:410

1.4.3.3 Gateway(s)

The table below defines the 'Gateway(s)' of the 'BP0523. Validate Declaration Request' process.

Element Name	Description	Special Type
BPE0033. Merge Invalid Flows	Merge into exclusive event based gateway the invalid flows from all validation tasks.	Merge

CARM Customs Declaration and Excise Documents Processing system (CDEPS)	REF: CDEPS_EXPORT_BPS
Business Process Specifications for EXPORT System	VER:410

1.4.4.BP0005. Validate

Business Process Description

The following table provides general information about the 'BP0005. Validate' process. The Business Process Diagram and the description of various business process elements are specified in the following paragraphs.

Description	Reusable subprocess that performs the message validation tasks
Precondition(s)	None
Trigger	The process is triggered when an electronic message is received for validation.
Postcondition(s)	

Business Process Diagram

The Business Process Diagram of 'BP0005. Validate' is shown below in BPMN notation. The definition of a process that might be used as sub-process by the 'BP0005. Validate' can be found in this document. Finally, Annex A of CDEPS-BPS-EXPORT provides some explanatory information about the used notation.

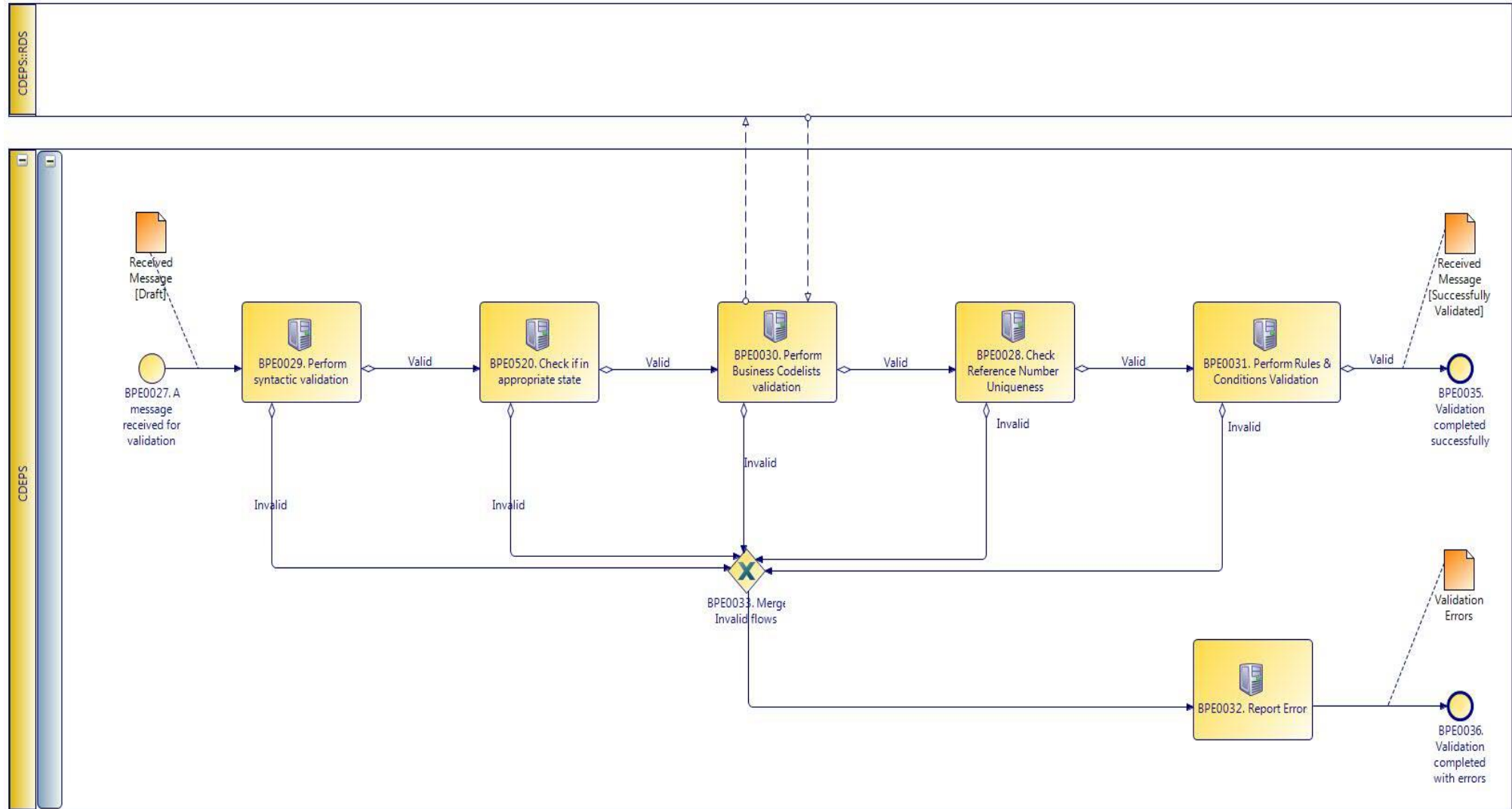

CARM Customs Declaration and Excise Documents Processing system (CDEPS)	REF: CDEPS_EXPORT_BPS
Business Process Specifications for EXPORT System	VER:410

1.4.4.1 Activities

The table below defines the 'Activities' of the 'BP0005. Validate' process.

Element Name	Description	Special Type
BPE0028. Check Reference Number Uniqueness	Check whether message reference numbers are unique in the system.	Service Task
↳ Business Rule 1	<i>Check Message Identification uniqueness</i>	
↳ Business Rule 74	<i>Check Local Reference Number (LRN) uniqueness</i>	
↳ Business Rule 75	<i>Check Movement Reference Number (MRN)uniqueness</i>	
↳ Business Rule 79	<i>Check Manifest reference number uniqueness</i>	
BPE0029. Perform syntactic validation	Check messages against the XSDs.	Service Task
↳ Business Rule 47	<i>Syntactic validation</i>	
BPE0030. Perform Business Codelists validation	Check the message business codelists.	Service Task
↳ Business Rule 50	<i>Business codelist validation against CDEPS:RDS</i>	
BPE0031. Perform Rules & Conditions Validation	Check the rules and conditions of the respective message.	Service Task
BPE0032. Report Errors	Report the identified errors from the validation process. The process terminates.	Service Task
BPE0520. Check if in appropriate state	Check whether the process for the particular entity (e.g. declaration/ application/ document) is on the appropriate state to process the received message. This check shall be performed based on the pertinent State Model of the system.	Service Task
↳ Business Rule 421	<i>Supplementary Declaration validation at Export</i>	
↳ Business Rule 448	<i>Check appropriate state for Export Declaration Amendment</i>	

CARM Customs Declaration and Excise Documents Processing system (CDEPS)	REF: CDEPS_EXPORT_BPS
Business Process Specifications for EXPORT System	VER:410

- ↳ **Business Rule** 449 *Check appropriate state Declaration Goods Presentation*
- ↳ **Business Rule** 468 *Guarantee Amendment*
- ↳ **Business Rule** 492 *Exit control results received at Export*
- ↳ **Business Rule** 493 *Export Declaration request at Export*

1.4.4.2 Event(s)

The table below defines the 'Event(s)' of the 'BP0005. Validate' process.

Element Name	Description	Special Type
BPE0027. A message or event notification from GUI is received for validation	Message input in the validation process.	Start
BPE0035. Validation completed successfully	The validation is completed successfully with no errors reported. The process terminates.	End
BPE0036. Validation completed with errors	The validation completed with errors. The process terminates.	End

1.4.4.3 Gateway(s)

The table below defines the 'Gateway(s)' of the 'BP0005. Validate' process.

Element Name	Description	Special Type
BPE0033. Merge Invalid Flows	Merge into exclusive event based gateway the invalid flows from all validation tasks.	Merge

CARM Customs Declaration and Excise Documents Processing system (CDEPS)	REF: CDEPS_EXPORT_BPS
Business Process Specifications for EXPORT System	VER:410

1.5. Process Group: Exit Summary operation exit at Exit

1.5.1.BP0915. Retrieve Statistics Information

Business Process Description

The following table provides general information about the 'BP0915. Retrieve Statistics Information' process. The Business Process Diagram and the description of various business process elements are specified in the following paragraphs.

Description	Handles the Business Statistics at Export Control System and sending the IE411 to CS/MIS.
Precondition(s)	
Trigger	
Postcondition(s)	

Business Process Diagram

The Business Process Diagram of 'BP0915. Retrieve Statistics Information' is shown below in BPMN notation. The definition of a process that might be used as sub-process by the 'BP0915. Retrieve Statistics Information' can be found in this document. Finally, Annex A of CDEPS-BPS-EXPORT provides some explanatory information about the used notation.

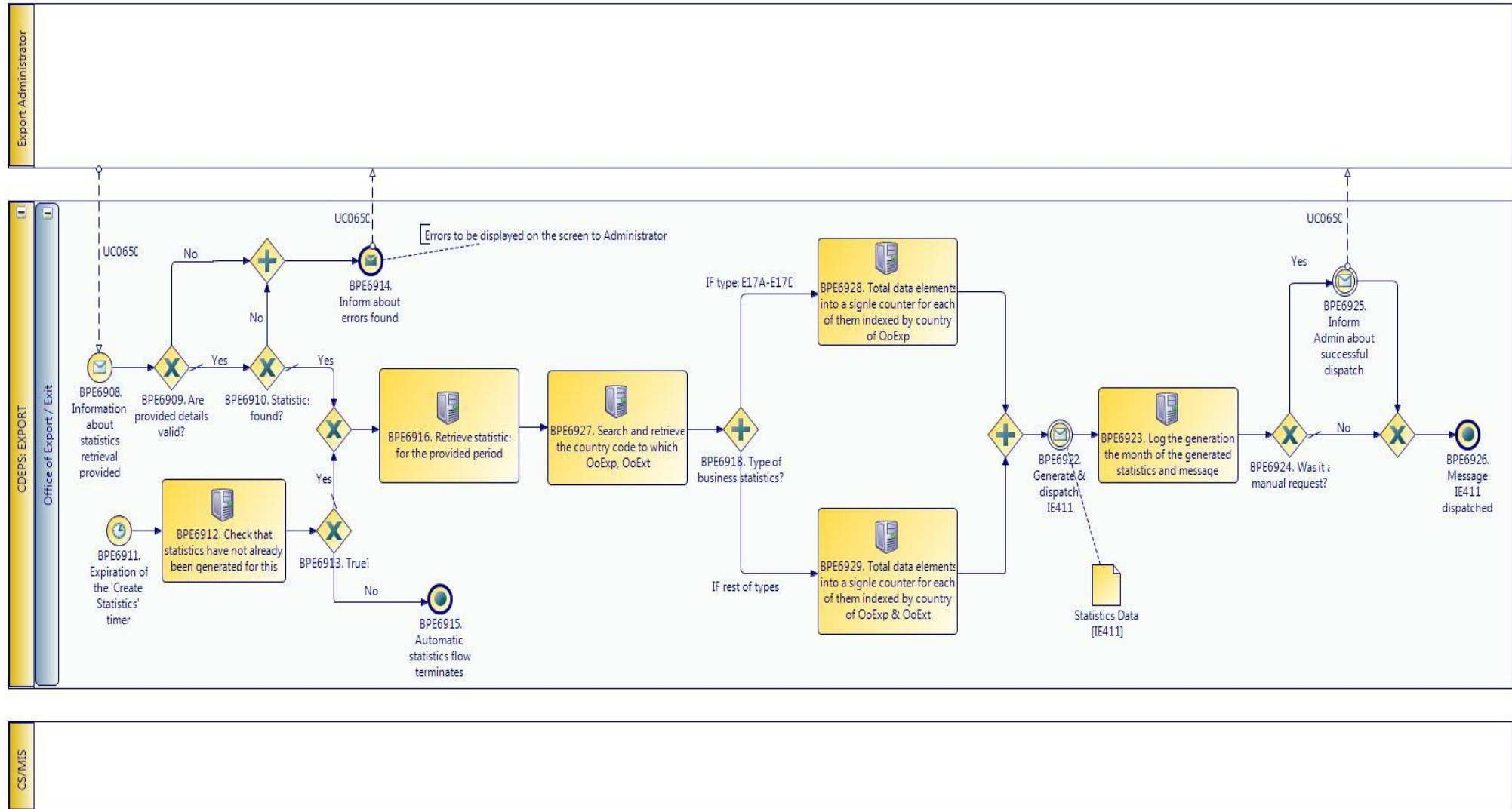

CARM Customs Declaration and Excise Documents Processing system (CDEPS)	REF: CDEPS_EXPORT_BPS
Business Process Specifications for EXPORT System	VER:410

1.5.1.1 Activities

The table below defines the 'Activities' of the 'BP0915. Retrieve Statistics Information' process.

Element Name	Description	Special Type
BPE6912. Check that statistics have not already been generated for this	Check that statistics have not already been generated for this	Service Task
BPE6916. Retrieve statistics for the provided period	Retrieve statistics for the provided period.	Service Task
BPE6923. Log the generation, the month of the generated statistics and message	Log the generation, the month of the generated statistics and message.	Service Task
BPE6927. Search and retrieve the country code to which OoExp, OoExt	Search and retrieve the country code to which OoExp, OoExt.	Service Task
BPE6928. Total data elements into a single counter for each of them indexed by country of OoExp	Total data elements into a single counter for each of them indexed by country of OoExp.	Service Task
BPE6929. Total data elements into a single counter for each of them indexed by country of OoExp & OoExt	Total data elements into a single counter for each of them indexed by country of OoExp & OoExt.	Service Task

CARM Customs Declaration and Excise Documents Processing system (CDEPS)	REF: CDEPS_EXPORT_BPS
Business Process Specifications for EXPORT System	VER:410

1.5.1.2 Event(s)

The table below defines the 'Event(s)' of the 'BP0915. Retrieve Statistics Information' process.

Element Name	Description	Special Type
BPE6908. Information about statistics retrieval provided	Information about statistics retrieval provided by the administrator.	Start
BPE6911. Expiration of the 'Create Statistics' timer	Expiration of the 'Create Statistics' timer.	Start
BPE6914. Inform about errors found	Inform about errors found.	End
BPE6915. Automatic statistics flow terminates	Automatic statistics flow terminates.	End
BPE6922. Generate & dispatch IE411	Generate & dispatch IE411.	Intermediate
BPE6925. Inform Admin about successful dispatch	Inform Admin about successful dispatch.	Intermediate
BPE6926. Message IE411 dispatched	Message IE411 dispatched.	End

1.5.1.3 Gateway(s)

The table below defines the 'Gateway(s)' of the 'BP0915. Retrieve Statistics Information' process.

Element Name	Description	Special Type
BPE6909. Are provided details valid?	Are provided details valid?	Decision
BPE6910. Statistics found?	Statistics found?	Decision
BPE6913. True?	True?	Decision

CARM Customs Declaration and Excise Documents Processing system (CDEPS)	REF: CDEPS_EXPORT_BPS
Business Process Specifications for EXPORT System	VER:410

BPE6918. Type of business statistics?	Type of business statistics?	Decision
BPE6924. Was it a manual request?	Was it a manual request?	Decision

CARM Customs Declaration and Excise Documents Processing system (CDEPS)	REF: CDEPS_EXPORT_BPS
Business Process Specifications for EXPORT System	VER:410

1.5.2.BP0917. Update Statistics Information

Business Process Description

The following table provides general information about the 'BP0917. Update Statistics Information' process. The Business Process Diagram and the description of various business process elements are specified in the following paragraphs.

Description	Handles the updating of Business Statistics at Export Control System.
Precondition(s)	
Trigger	
Postcondition(s)	

Business Process Diagram

The Business Process Diagram of 'BP0917. Update Statistics Information' is shown below in BPMN notation. The definition of a process that might be used as sub-process by the 'BP0917. Update Statistics Information' can be found in this document. Finally, Annex A of CDEPS-BPS-EXPORT provides some explanatory information about the used notation.

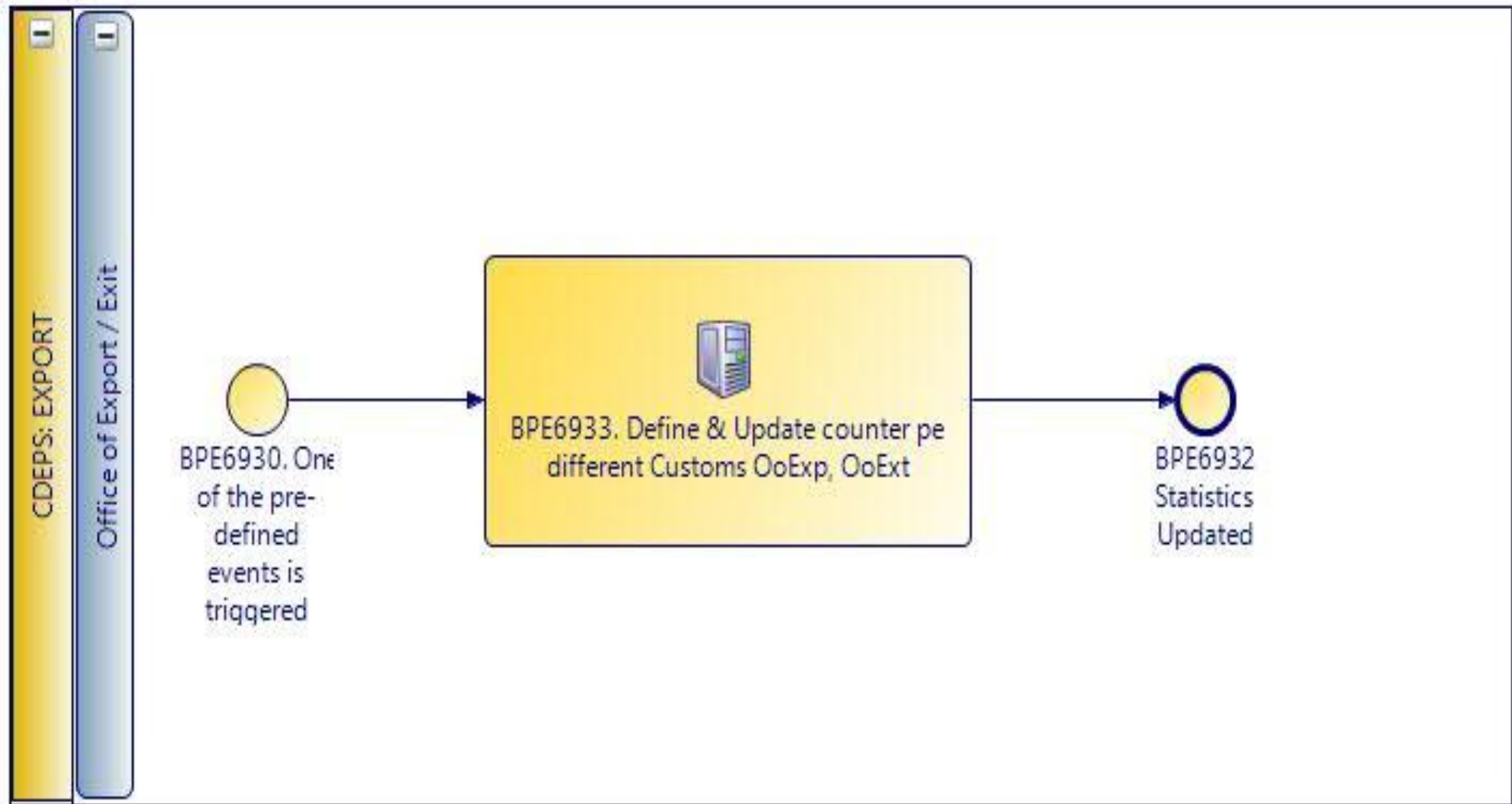

CARM Customs Declaration and Excise Documents Processing system (CDEPS)	REF: CDEPS_EXPORT_BPS
Business Process Specifications for EXPORT System	VER:410

1.5.2.1 Activities

The table below defines the 'Activities' of the 'BP0917. Update Statistics Information' process.

Element Name	Description	Special Type
BPE6933. Define & Update counter per different Customs OoExp, OoExt	Define & Update counter per different Customs OoExp, OoExt.	Service Task

1.5.2.2 Event(s)

The table below defines the 'Event(s)' of the 'BP0917. Update Statistics Information' process.

Element Name	Description	Special Type
BPE6930. One of the pre-defined events is triggered	One of the pre-defined events is triggered.	Start
BPE6932. Statistics Updated	Statistics Updated.	End

CARM Customs Declaration and Excise Documents Processing system (CDEPS)	REF: CDEPS_EXPORT_BPS
Business Process Specifications for EXPORT System	VER:410

1.5.3.BP0143. Process Exit @ Actual Office of Exit

Business Process Description

The following table provides general information about the 'BP0143. Process Exit @ Actual Office of Exit' process. The Business Process Diagram and the description of various business process elements are specified in the following paragraphs.

Description	A high level process describing the actions performed by the system in order to process the exit of the movement at the Actual Office of Exit
Precondition(s)	Goods are released for Exit
Trigger	The processed is triggered by the manifest presentation either received electronically by the Trader or captured manually by the Customs Officer
Postcondition(s)	None

Business Process Diagram

The Business Process Diagram of 'BP0143. Process Exit @ Actual Office of Exit' is shown below in BPMN notation. The definition of a process that might be used as sub-process by the 'BP0143. Process Exit @ Actual Office of Exit' can be found in this document. Finally, Annex A of CDEPS-BPS-EXPORT provides some explanatory information about the used notation.

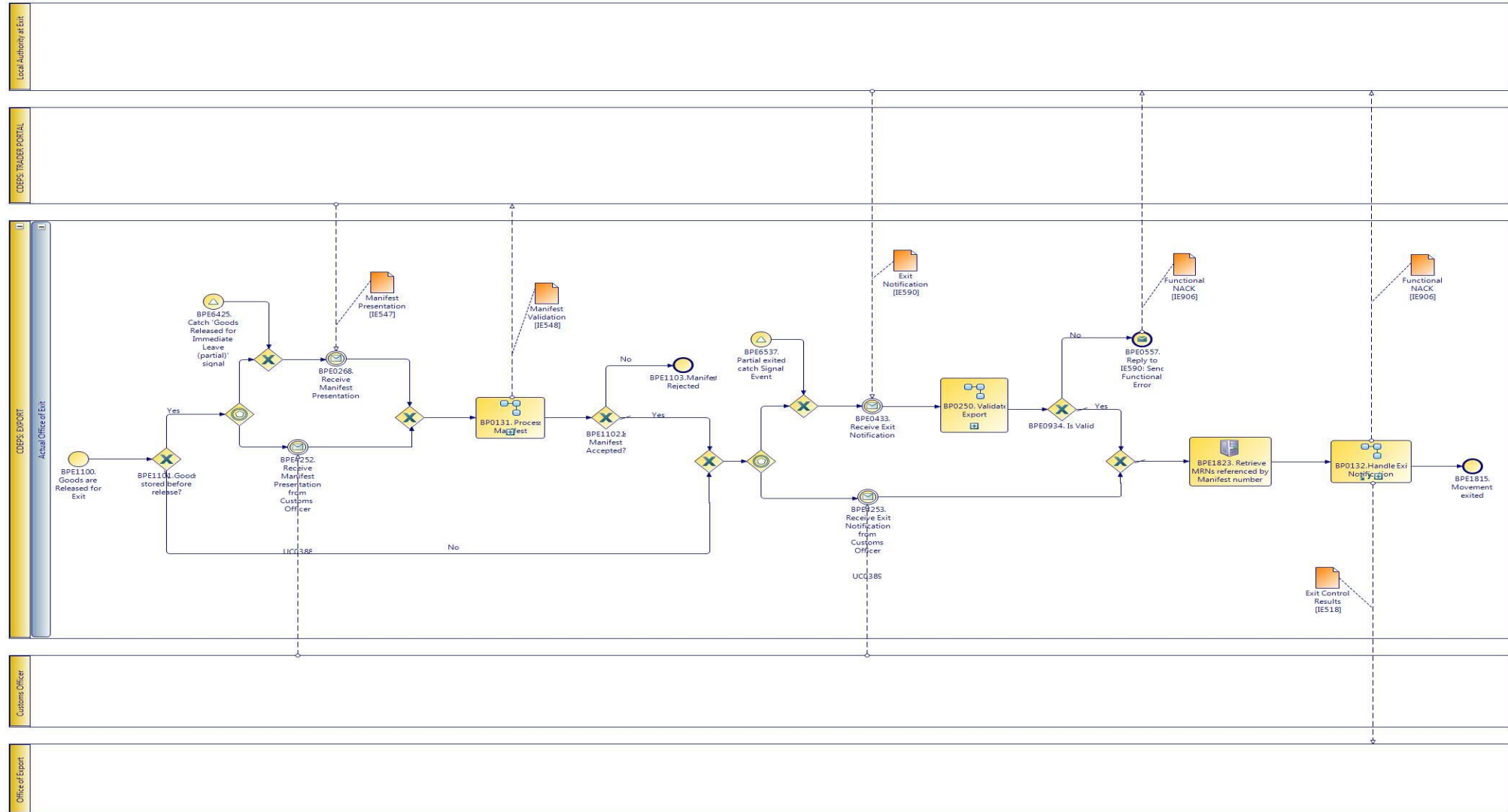

CARM Customs Declaration and Excise Documents Processing system (CDEPS)	REF: CDEPS_EXPORT_BPS
Business Process Specifications for EXPORT System	VER:410

1.5.3.1 Activities

The table below defines the 'Activities' of the 'BP0143. Process Exit @ Actual Office of Exit' process.

Element Name	Description	Special Type
BPE1823. Retrieve MRNs referenced by Manifest number	The system retrieves and processes the MRNs referenced by the specific manifest number.	Service Task

1.5.3.2 Event(s)

The table below defines the 'Event(s)' of the 'BP0143. Process Exit @ Actual Office of Exit' process.

Element Name	Description	Special Type
BPE0268. Receive Manifest Presentation	Trader at Exit presents manifest	Intermediate
BPE0433. Receive Exit Notification	The system in the Actual Office of Exit receives an Exit Notification (IE590) by the Local Authorities in charge of verifying the actual exit.	Start
BPE0557. Reply to IE590: Send Functional Error	Send functional error in case of rejection	End
BPE1100. Goods are Released for Exit	The goods have been released for Exit and their processing at the Actual Office of Exit begins.	Start
BPE1103. Manifest Rejected	The Manifest has been rejected upon its invalidation. The process terminates.	End
BPE1815. Movement exited	The movement is exited and the process terminates.	End
BPE4252. Receive Manifest Presentation from Customs Officer	Customs Officer at Exit presents Manifest	Intermediate
BPE6425. Catch 'Goods Released for Immediate Leave (partial)' signal	Catch 'Goods Released for Immediate Leave (partial)' signal	Start

CARM Customs Declaration and Excise Documents Processing system (CDEPS)	REF: CDEPS_EXPORT_BPS
Business Process Specifications for EXPORT System	VER:410

BPE6537. Partial exited catch Signal Event A start event that catches the partial exited signal event Start

1.5.3.3 Gateway(s)

The table below defines the 'Gateway(s)' of the 'BP0143. Process Exit @ Actual Office of Exit' process.

Element Name	Description	Special Type
BPE0934. Is Valid?	A decision point in the process to navigate the flow based on the message validation result.	Decision
↳ Business Rule 638	<i>Import declaration type 'X' cannot be cancelled</i>	
↳ Business Rule 646	<i>Guarantees during the registration of Import declaration type 'X'</i>	
↳ Business Rule 80	<i>Valid Message</i>	
BPE1101. Goods stored before release?	A decision point in the process to navigate the flow based on whether the goods have been stored before their release.	Decision
BPE1102. Is Manifest Accepted?	A decision point in the process to navigate the flow based on whether the received manifest has been accepted.	Decision

CARM Customs Declaration and Excise Documents Processing system (CDEPS)	REF: CDEPS_EXPORT_BPS
Business Process Specifications for EXPORT System	VER:410

1.5.4.BP0131. Process Manifest

Business Process Description

The following table provides general information about the 'BP0131. Process Manifest' process. The Business Process Diagram and the description of various business process elements are specified in the following paragraphs.

Description	The process describes the actions performed by the system in order to process the manifest received
Precondition(s)	Manifest Presentation is Received
Trigger	The process is triggered when a manifest presentation is received
Postcondition(s)	<ul style="list-style-type: none"> - None - Goods Released for Immediate Leave (partial) - Goods Released for Immediate Leave - Partially Exited

Business Process Diagram

The Business Process Diagram of 'BP0131. Process Manifest' is shown below in BPMN notation. The definition of a process that might be used as sub-process by the 'BP0131. Process Manifest' can be found in this document. Finally, Annex A of CDEPS-BPS-EXPORT provides some explanatory information about the used notation.

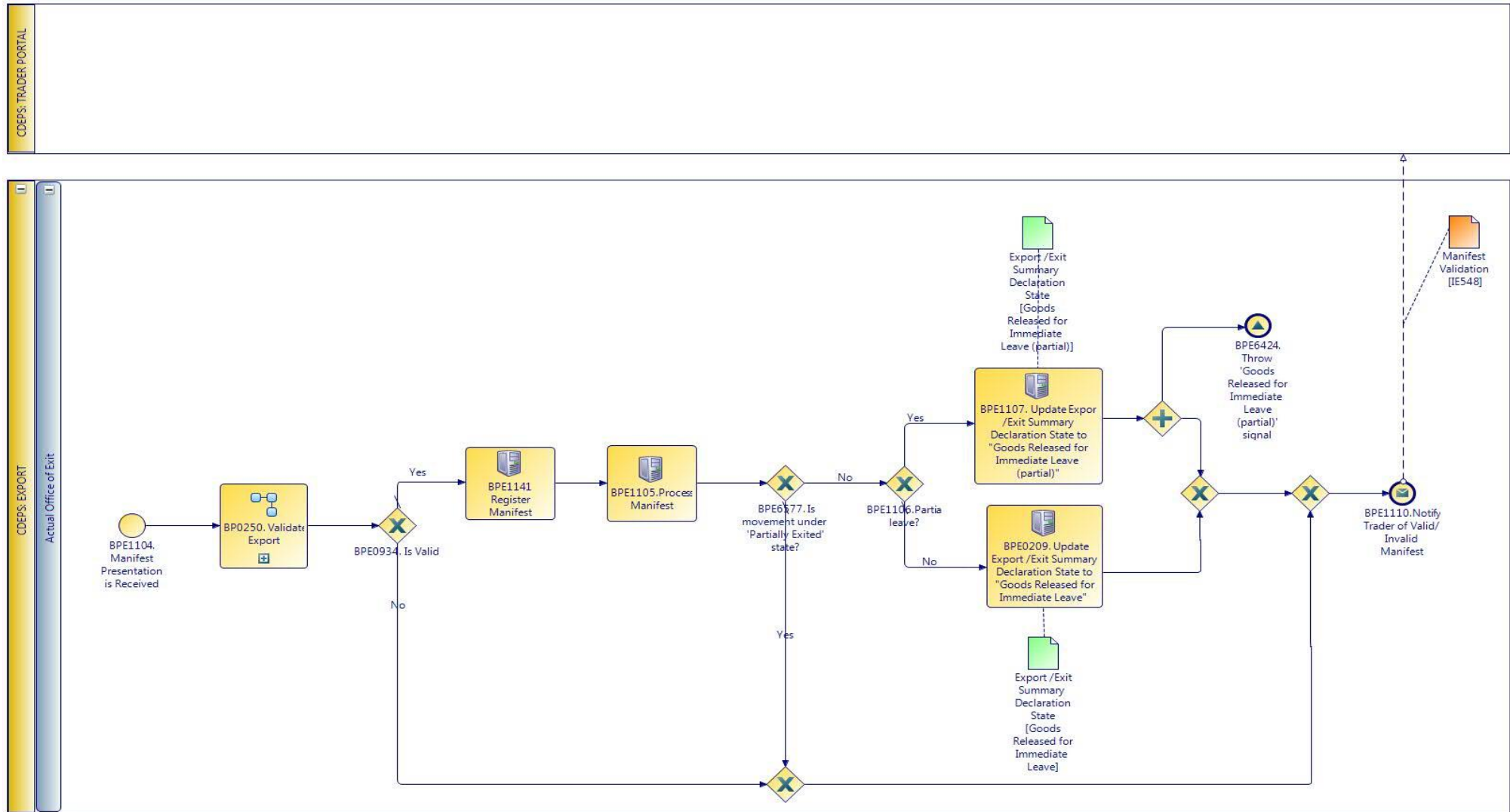

CARM Customs Declaration and Excise Documents Processing system (CDEPS)	REF: CDEPS_EXPORT_BPS
Business Process Specifications for EXPORT System	VER:410

1.5.4.1 Activities

The table below defines the 'Activities' of the 'BP0131. Process Manifest' process.

Element Name	Description	Special Type
BPE0209. Update Export /Exit Summary Declaration State to "Goods Released for Immediate Leave"	The system updates the Export /Exit Summary Declaration State to "Goods released for immediate leave".	
BPE1105. Process Manifest	The system handles and processes the manifest presentation received by the Trader upon its validation.	Service Task
↳ Business Rule	416 <i>Manifest Number structure</i>	
BPE1107. Update Export /Exit Summary Declaration State to "Goods Released for Immediate Leave (partial)"	The system updates the Export /Exit Summary Declaration State to "Goods Released for Immediate Leave" (partial) upon the decision of goods partial leave.	Service Task
BPE1141. Register Manifest	The system registers the manifest presented at the Office of Exit	Service Task

1.5.4.2 Event(s)

The table below defines the 'Event(s)' of the 'BP0131. Process Manifest' process.

Element Name	Description	Special Type
BPE1104. Manifest Presentation is Received	In case the goods are stored before release, the Manifest Presentation sent by the Trader is received.	Start
BPE1110. Notify Trader of Valid/Invalid Manifest	The Trader is being notified that the manifest has been either validated or invalidated	End

CARM Customs Declaration and Excise Documents Processing system (CDEPS)	REF: CDEPS_EXPORT_BPS
Business Process Specifications for EXPORT System	VER:410

BPE6424. Throw 'Goods Released for Immediate Leave (partial)' signal End

1.5.4.3 Gateway(s)

The table below defines the 'Gateway(s)' of the 'BP0131. Process Manifest' process.

Element Name	Description	Special Type
BPE0934. Is Valid?	A decision point in the process to navigate the flow based on the message validation result.	Decision
↳ Business Rule 638	<i>Import declaration type 'X' cannot be cancelled</i>	
↳ Business Rule 646	<i>Guarantees during the registration of Import declaration type 'X'</i>	
↳ Business Rule 80	<i>Valid Message</i>	
BPE1106. Partial leave?	A decision point in the process to navigate the flow based on whether the goods have been released for partial leave or not.	Decision
BPE6577. Is movement under 'Partially Exited' state?	Is movement under 'Partially Exited' state?	Decision

CARM Customs Declaration and Excise Documents Processing system (CDEPS)	REF: CDEPS_EXPORT_BPS
Business Process Specifications for EXPORT System	VER:410

1.5.5.BP0250. Validate Export

Business Process Description

The following table provides general information about the 'BP0250. Validate Export' process. The Business Process Diagram and the description of various business process elements are specified in the following paragraphs.

Description	Reusable subprocess that performs the message validation tasks for Export Regime.
Precondition(s)	None
Trigger	The process is triggered when an electronic message is received for validation.
Postcondition(s)	The validation is either completed successfully or with errors reported

Business Process Diagram

The Business Process Diagram of 'BP0250. Validate Export' is shown below in BPMN notation. The definition of a process that might be used as sub-process by the 'BP0250. Validate Export' can be found in this document. Finally, Annex A of CDEPS-BPS-EXPORT provides some explanatory information about the used notation.

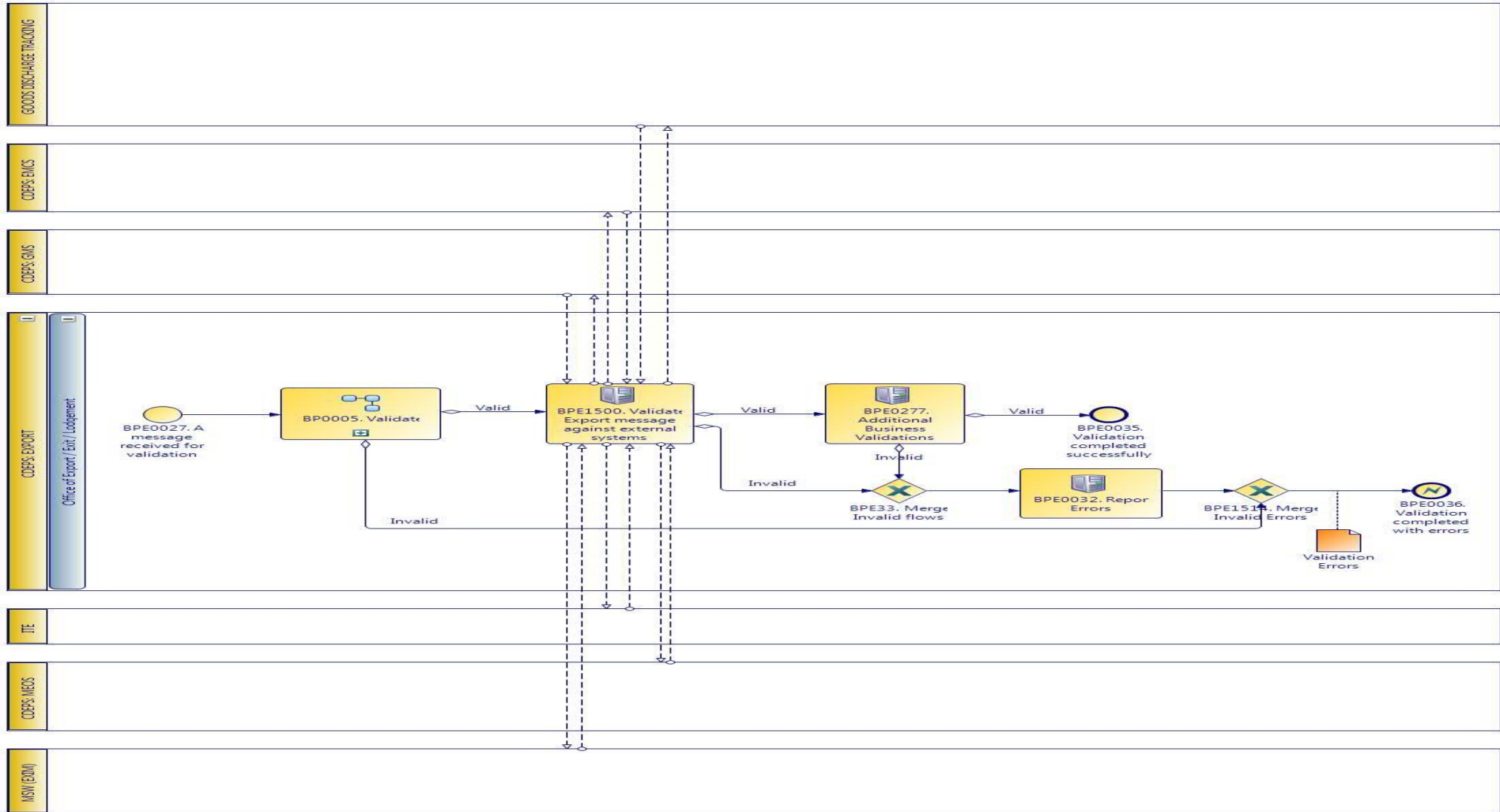

CARM Customs Declaration and Excise Documents Processing system (CDEPS)	REF: CDEPS_EXPORT_BPS
Business Process Specifications for EXPORT System	VER:410

1.5.5.1 Activities

The table below defines the 'Activities' of the 'BP0250. Validate Export' process.

Element Name	Description	Special Type
BPE0032. Report Errors	Report the identified errors from the validation process. The process terminates.	Service Task
BPE0277. Additional Business Validations for Export	The system performs any additional business validations specific to Export System.	Service Task
↳ Business Rule 19	Trader amending data same as Person lodging the declaration	
↳ Business Rule 21	Reject ENS/EXS amendment if ENS/EXS is not in appropriate state	
↳ Business Rule 245	Validate Personal ID	
↳ Business Rule 39	Cancellation Constraint	
↳ Business Rule 520	Import/ Export allowed guarantee types	
↳ Business Rule 70	EXS exists at the Office of Exit	
↳ Business Rule 71	Manifest number in IE547 and IE590	
BPE1500. Validate Export message against external systems	The system performs message validations against external systems.	Service Task
↳ Business Rule 101	Validate Economic Operator against MEOS	
↳ Business Rule 422	Validation of NCTS notifications	
↳ Business Rule 425	Goods Discharge required	
↳ Business Rule 439	Validate against GMS for integrity check	
↳ Business Rule 440	Validate Economic Operator's TIN against MEOS	
↳ Business Rule 494	Orchestrate validation of Export message against external systems	
↳ Business Rule 508	Validation of Export licenses with EXIM	

CARM Customs Declaration and Excise Documents Processing system (CDEPS)	REF: CDEPS_EXPORT_BPS
Business Process Specifications for EXPORT System	VER:410
↳ Business Rule 509	Check Export authorizations with MEOS
↳ Business Rule 51	Validate declared Combined Nomenclature in Declaration against ITE.
↳ Business Rule 510	Check Export authorizations for representation with MEOS
↳ Business Rule 511	Check Evidence of Power of Attorney with MEOS
↳ Business Rule 521	Validate Export declaration against ITE (duty calculation).
↳ Business Rule 522	Validate Export declaration data against Goods Discharge Tracking system
↳ Business Rule 527	Validate Export Declaration data against Excise system

1.5.5.2 Event(s)

The table below defines the 'Event(s)' of the 'BP0250. Validate Export' process.

Element Name	Description	Special Type
BPE0027. A message or event notification from GUI is received for validation	Message input in the validation process.	Start
BPE0035. Validation completed successfully	The validation is completed successfully with no errors reported. The process terminates.	End
BPE0036. Validation completed with errors	The validation completed with errors. The process terminates.	End

1.5.5.3 Gateway(s)

The table below defines the 'Gateway(s)' of the 'BP0250. Validate Export' process.

Element Name	Description	Special Type
BPE1514. Merge Invalid Errors	Combines exclusively either the negative outcome of generic validate process (BP0005. Validate) which reports errors or the errors from the extra checks for the specific system.	Merge

CARM Customs Declaration and Excise Documents Processing system (CDEPS)	REF: CDEPS_EXPORT_BPS
Business Process Specifications for EXPORT System	VER:410

1.5.6.BP0132. Handle Exit Notification

Business Process Description

The following table provides general information about the 'BP0132. Handle Exit Notification' process. The Business Process Diagram and the description of various business process elements are specified in the following paragraphs.

Description	The process describes the actions performed by the system in order to handle the received Exit Notification
Precondition(s)	Exit Notification is received
Trigger	The process is triggered when an Exit Notification is received.
Postcondition(s)	- None - Exited

Business Process Diagram

The Business Process Diagram of 'BP0132. Handle Exit Notification' is shown below in BPMN notation. The definition of a process that might be used as sub-process by the 'BP0132. Handle Exit Notification' can be found in this document. Finally, Annex A of CDEPS-BPS-EXPORT provides some explanatory information about the used notation.

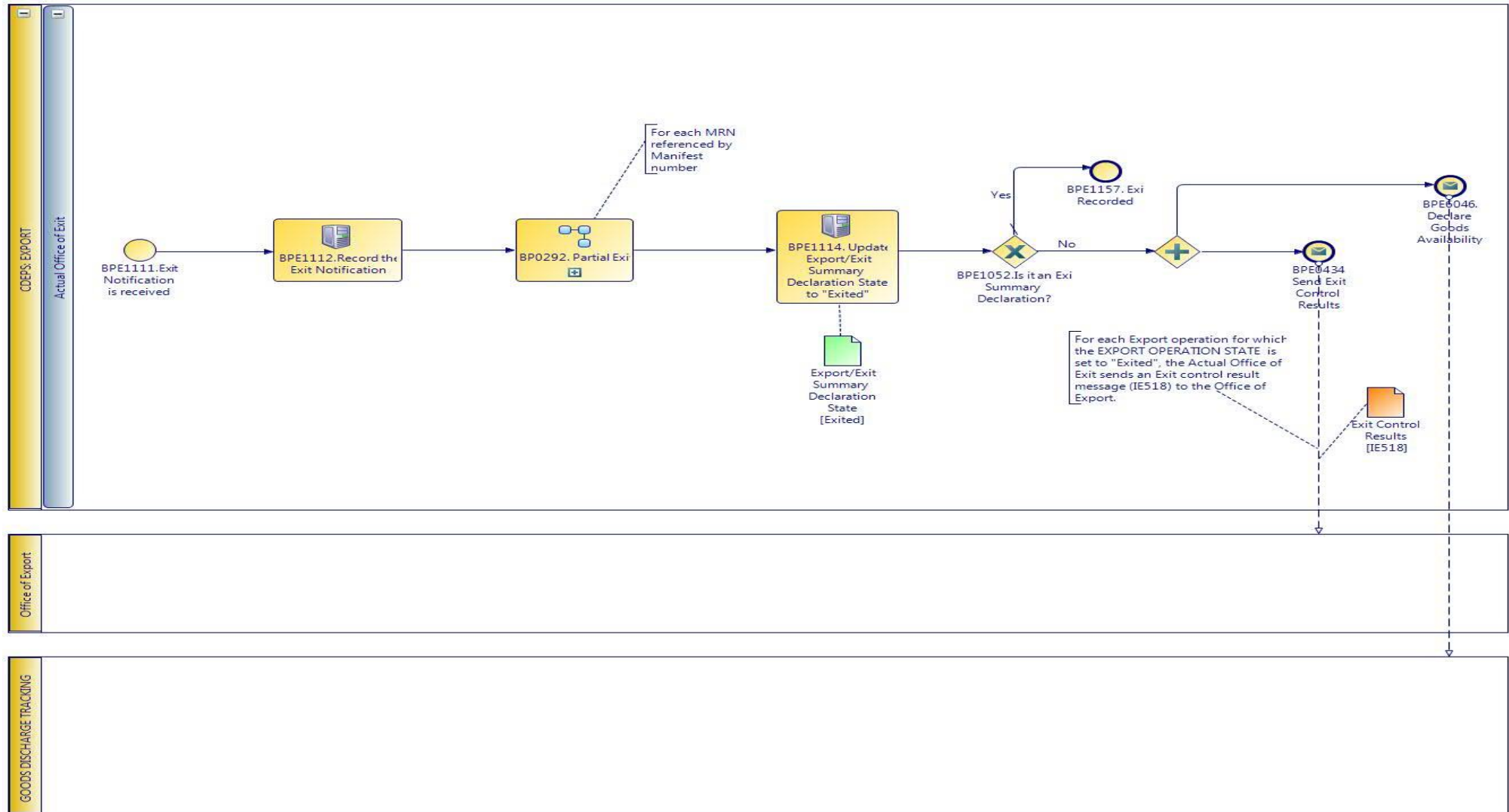

CARM Customs Declaration and Excise Documents Processing system (CDEPS)	REF: CDEPS_EXPORT_BPS
Business Process Specifications for EXPORT System	VER:410

1.5.6.1 Activities

The table below defines the 'Activities' of the 'BP0132. Handle Exit Notification' process.

Element Name	Description	Special Type
BPE0556. Reject Exit Notification	In case of validation errors identified, reject Exit Notification	User Task
BPE1112. Record the Exit Notification	The validated Exit Notification received by the Local Authority at Exit is being recorded into the system.	Service Task
BPE1114. Update Export/Exit Summary Declaration State to "Exited"	The system updates the Export/Exit Summary Declaration state to "Exited" upon the total exit of the goods.	Service Task

1.5.6.2 Event(s)

The table below defines the 'Event(s)' of the 'BP0132. Handle Exit Notification' process.

Element Name	Description	Special Type
BPE0434. Send Exit Control Results	The system at the Office of Exit sends the exit control results (IE518) to the Office of Export.	End
BPE1111. Exit Notification is received	The system receives the Exit Notification by the Local Authority at Exit and the process begins.	Start
BPE1157. Exit Recorded	The Exit Summary declaration has been recorded an the process terminates.	End
BPE6046. Declare Goods Availability	The current document declare its goods as available to be used by upcoming Movements.	End
↳ Business Rule	604 Goods availability to Discharge Module according previous procedure	
↳ Business Rule	605 Goods availability to Discharge Module according procedure	
↳ Business Rule	640 Import declaration type 'X' to discharge module	

CARM Customs Declaration and Excise Documents Processing system (CDEPS)	REF: CDEPS_EXPORT_BPS
Business Process Specifications for EXPORT System	VER:410

1.5.6.3 Gateway(s)

The table below defines the 'Gateway(s)' of the 'BP0132. Handle Exit Notification' process.

Element Name	Description	Special Type
BPE1052. Is it an Exit Summary Declaration?	A decision point on the process to navigate the flow based on the type of the declaration (Export or Exit Summary).	Decision

CARM Customs Declaration and Excise Documents Processing system (CDEPS)	REF: CDEPS_EXPORT_BPS
Business Process Specifications for EXPORT System	VER:410

1.5.7.BP0292. Partial Exit

Business Process Description

The following table provides general information about the 'BP0292. Partial Exit' process. The Business Process Diagram and the description of various business process elements are specified in the following paragraphs.

Description	The process describes the actions performed by the system in order to handle the partial exit
Precondition(s)	Export Goods Item referenced by Manifest Number received
Trigger	The process is triggered when the Export Goods Item referenced by Manifest Number are received.
Postcondition(s)	- None - Partially Exited

Business Process Diagram

The Business Process Diagram of 'BP0292. Partial Exit' is shown below in BPMN notation. The definition of a process that might be used as sub-process by the 'BP0292. Partial Exit' can be found in this document. Finally, Annex A of CDEPS-BPS-EXPORT provides some explanatory information about the used notation.

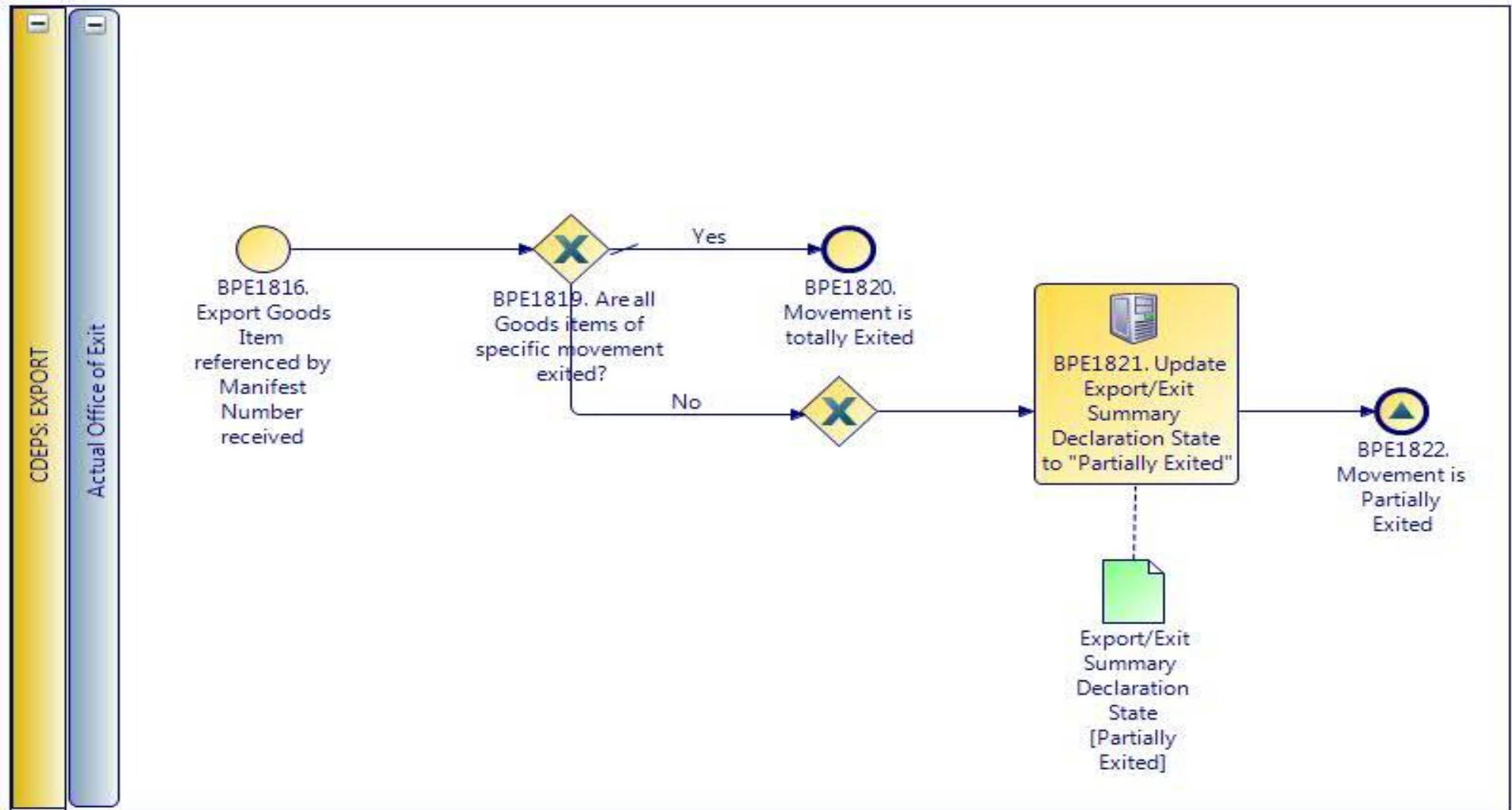

CARM Customs Declaration and Excise Documents Processing system (CDEPS)	REF: CDEPS_EXPORT_BPS
Business Process Specifications for EXPORT System	VER:410

1.5.7.1 Activities

The table below defines the 'Activities' of the 'BP0292. Partial Exit' process.

Element Name	Description	Special Type
BPE1821. Update Export/Exit Summary Declaration State to "Partially Exited"	The system updates the Export/Exit Summary Declaration State to "Partially Exited".	Service Task

1.5.7.2 Event(s)

The table below defines the 'Event(s)' of the 'BP0292. Partial Exit' process.

Element Name	Description	Special Type
BPE1816. Export Goods Item referenced by Manifest Number received	Export Goods Item referenced by Manifest Number received	Start
BPE1820. Movement is totally Exited	The Movement is totally Exited and the process terminates.	End
BPE1822. Movement is Partially Exited	The Movement is Partially Exited and the process terminates.	End

1.5.7.3 Gateway(s)

The table below defines the 'Gateway(s)' of the 'BP0292. Partial Exit' process.

Element Name	Description	Special Type
BPE1819. Are all Goods items of specific movement exited?	A decision point in the process to navigate the flow based on whether all the goods of a specific movement are exited?	Decision

↳ **Business Rule** 68 *Check Partial Exit*

CARM Customs Declaration and Excise Documents Processing system (CDEPS)	REF: CDEPS_EXPORT_BPS
Business Process Specifications for EXPORT System	VER:410

1.5.8.BP0005. Validate

Business Process Description

The following table provides general information about the 'BP0005. Validate' process. The Business Process Diagram and the description of various business process elements are specified in the following paragraphs.

Description	Reusable subprocess that performs the message validation tasks
Precondition(s)	None
Trigger	The process is triggered when an electronic message is received for validation.
Postcondition(s)	

Business Process Diagram

The Business Process Diagram of 'BP0005. Validate' is shown below in BPMN notation. The definition of a process that might be used as sub-process by the 'BP0005. Validate' can be found in this document. Finally, Annex A of CDEPS-BPS-EXPORT provides some explanatory information about the used notation.

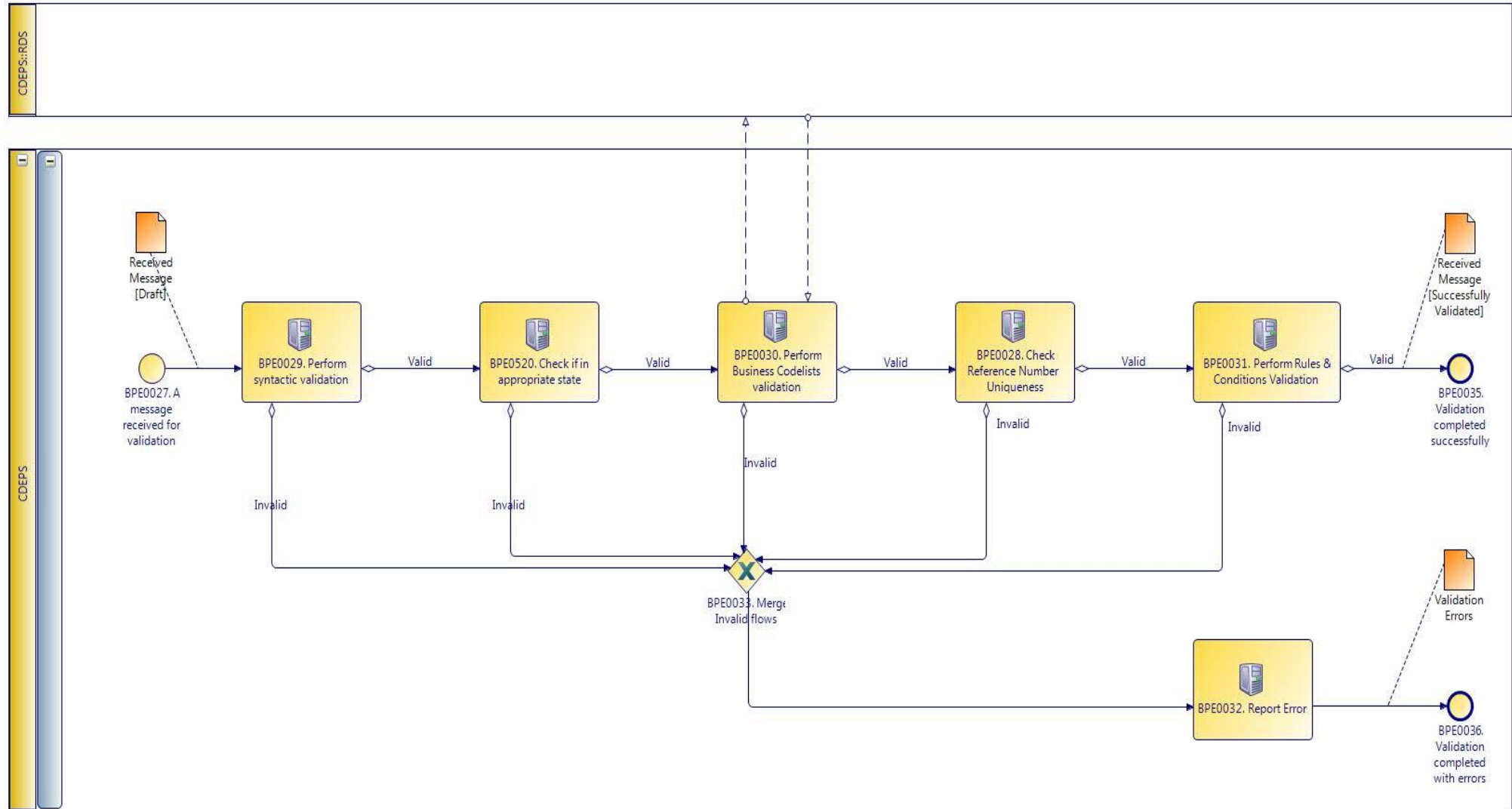

CARM Customs Declaration and Excise Documents Processing system (CDEPS)	REF: CDEPS_EXPORT_BPS
Business Process Specifications for EXPORT System	VER:410

1.5.8.1 Activities

The table below defines the 'Activities' of the 'BP0005. Validate' process.

Element Name	Description	Special Type
BPE0028. Check Reference Number Uniqueness	Check whether message reference numbers are unique in the system.	Service Task
↳ Business Rule 1	<i>Check Message Identification uniqueness</i>	
↳ Business Rule 74	<i>Check Local Reference Number (LRN) uniqueness</i>	
↳ Business Rule 75	<i>Check Movement Reference Number (MRN)uniqueness</i>	
↳ Business Rule 79	<i>Check Manifest reference number uniqueness</i>	
BPE0029. Perform syntactic validation	Check messages against the XSDs.	Service Task
↳ Business Rule 47	<i>Syntactic validation</i>	
BPE0030. Perform Business Codelists validation	Check the message business codelists.	Service Task
↳ Business Rule 50	<i>Business codelist validation against CDEPS:RDS</i>	
BPE0031. Perform Rules & Conditions Validation	Check the rules and conditions of the respective message.	Service Task
BPE0032. Report Errors	Report the identified errors from the validation process. The process terminates.	Service Task
BPE0520. Check if in appropriate state	Check whether the process for the particular entity (e.g. declaration/ application/ document) is on the appropriate state to process the received message. This check shall be performed based on the pertinent State Model of the system.	Service Task
↳ Business Rule 421	<i>Supplementary Declaration validation at Export</i>	
↳ Business Rule 448	<i>Check appropriate state for Export Declaration Amendment</i>	

CARM Customs Declaration and Excise Documents Processing system (CDEPS)	REF: CDEPS_EXPORT_BPS
Business Process Specifications for EXPORT System	VER:410

- ↳ **Business Rule** 449 *Check appropriate state Declaration Goods Presentation*
- ↳ **Business Rule** 468 *Guarantee Amendment*
- ↳ **Business Rule** 492 *Exit control results received at Export*
- ↳ **Business Rule** 493 *Export Declaration request at Export*

1.5.8.2 Event(s)

The table below defines the 'Event(s)' of the 'BP0005. Validate' process.

Element Name	Description	Special Type
BPE0027. A message or event notification from GUI is received for validation	Message input in the validation process.	Start
BPE0035. Validation completed successfully	The validation is completed successfully with no errors reported. The process terminates.	End
BPE0036. Validation completed with errors	The validation completed with errors. The process terminates.	End

1.5.8.3 Gateway(s)

The table below defines the 'Gateway(s)' of the 'BP0005. Validate' process.

Element Name	Description	Special Type
BPE0033. Merge Invalid Flows	Merge into exclusive event based gateway the invalid flows from all validation tasks.	Merge

CARM Customs Declaration and Excise Documents Processing system (CDEPS)	REF: CDEPS_EXPORT_BPS
Business Process Specifications for EXPORT System	VER:410

1.6. Process Group: Exit Summary operation Amendment at Exit

1.6.1.BP0524. Process Amendment @ Office of Exit

Business Process Description

The following table provides general information about the 'BP0524. Process Amendment @ Office of Exit' process. The Business Process Diagram and the description of various business process elements are specified in the following paragraphs.

Description	A master process describing the actions performed by the system in order to handle an amendment request received electronically from the Trader or on paper at the Office of Exit.
Precondition(s)	<ul style="list-style-type: none"> - Goods Presented at Exit - Declaration Under Amendment
Trigger	The process is triggered by the either the reception of an electronic amendment request by the Trader or manually by the Customs Officer
Postcondition(s)	<ul style="list-style-type: none"> - None - Declaration Under Amendment - EXS Amendment Accepted

Business Process Diagram

The Business Process Diagram of 'BP0524. Process Amendment @ Office of Exit' is shown below in BPMN notation. The definition of a process that might be used as sub-process by the 'BP0524. Process Amendment @ Office of Exit' can be found in this document. Finally, Annex A of CDEPS-BPS-EXPORT provides some explanatory information about the used notation.

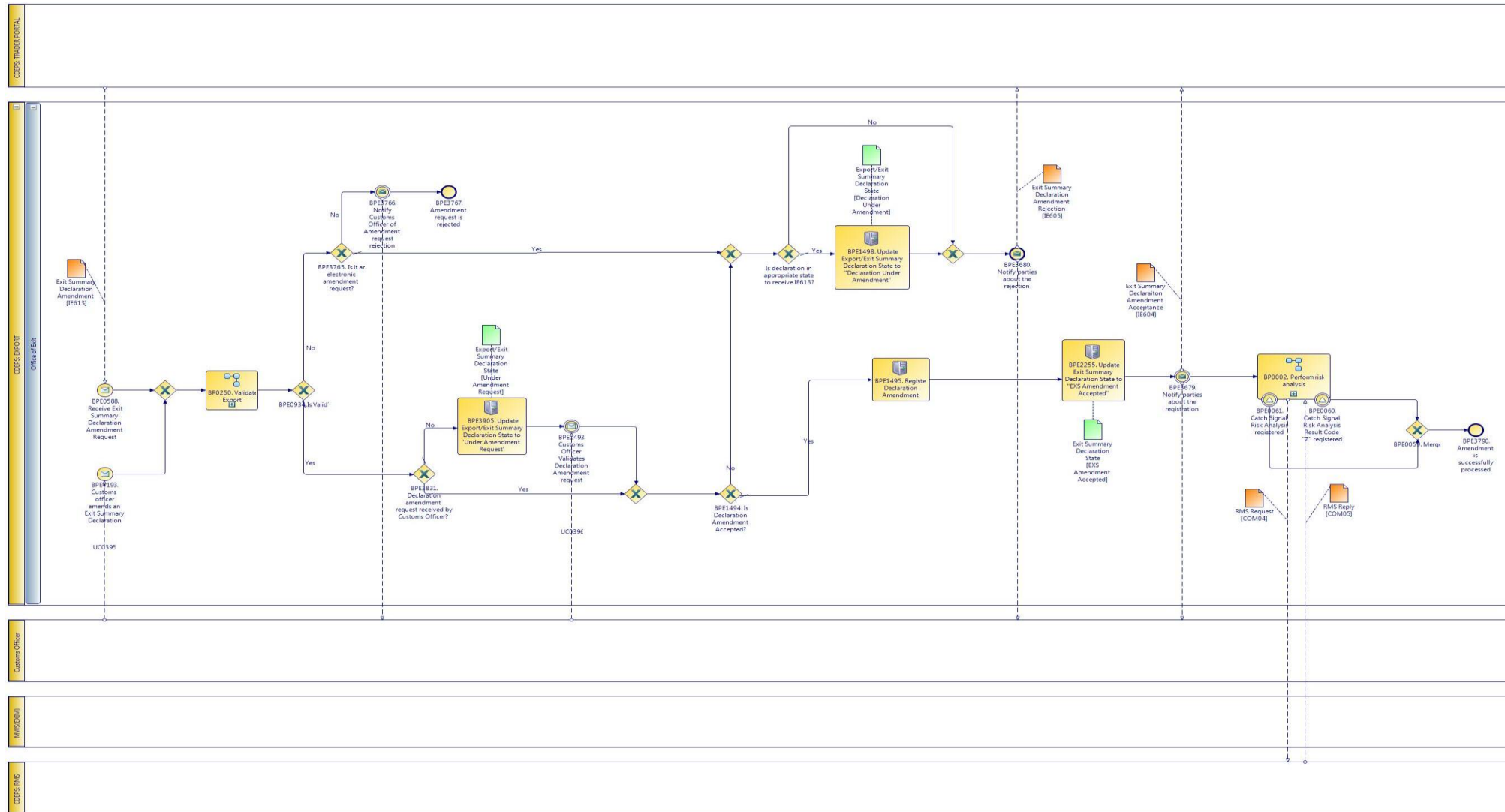

CARM Customs Declaration and Excise Documents Processing system (CDEPS)	REF: CDEPS_EXPORT_BPS
Business Process Specifications for EXPORT System	VER:410

1.6.1.1 Activities

The table below defines the 'Activities' of the 'BP0524. Process Amendment @ Office of Exit' process.

Element Name	Description	Special Type
BPE1495. Register Declaration Amendment	Upon its successful validation the declaration amendment request is registered in the system	Service Task
BPE1498. Update Export/Exit Summary Declaration State to "Declaration Under Amendment"	The system updates the Export/Exit Summary Declaration State to "Declaration Under Amendment" upon the rejection of the declaration amendment request	Service Task
BPE3905. Update Export/Exit Summary Declaration State to 'Under Amendment Request'	The system updates the state of the Export/Exit Summary Declaration to 'Under Amendment Request'	Service Task

1.6.1.2 Event(s)

The table below defines the 'Event(s)' of the 'BP0524. Process Amendment @ Office of Exit' process.

Element Name	Description	Special Type
BPE0061. Catch Signal Risk Analysis registered	Catch Signal Risk Analysis registered (RiskAnalysisCompletedOK).	Intermediate
BPE0588. Receive Exit Summary Declaration Amendment Request	Receive IE613 amending an accepted EXS	Start
BPE1493. Customs Officer Validates Declaration Amendment request	The Customs Officer validates the amendment request and the flow continues.	Intermediate

CARM Customs Declaration and Excise Documents Processing system (CDEPS)	REF: CDEPS_EXPORT_BPS
Business Process Specifications for EXPORT System	VER:410

BPE2255. Update Exit Summary Declaration State to "EXS Amendment Accepted"	The system updates the Exit Summary Declaration State to "EXS Amendment Accepted"	End
BPE3679. Notify parties about the registration	Upon the validation of the Declaration data the parties are notified of the successful registration	Intermediate
BPE3680. Notify parties about the rejection	Upon the invalidation of the Declaration data the parties are notified of the rejection	Intermediate
BPE3766. Notify Customs Officer of Amendment request rejection	Notify Customs Officer of Amendment request rejection	Intermediate
BPE3767. Amendment request is rejected	Amendment request is rejected	End
BPE3790. Amendment is successfully processed	The Amendment is successfully processed	End
BPE4193. Customs officer amends an Exit Summary Declaration	The Customs officer amends an Exit Summary Declaration	Start
BPE0060. Catch Signal Risk Analysis Result Code "Z" registered	Catch Signal Risk Analysis Result Code "Z" registered (RiskAnalysisZ)	Intermediate

1.6.1.3 Gateway(s)

The table below defines the 'Gateway(s)' of the 'BP0524. Process Amendment @ Office of Exit' process.

Element Name	Description	Special Type
BPE0059. Merge	Merge risk analysis completion signals	Merge
BPE0934. Is Valid?	A decision point in the process to navigate the flow based on the message validation result.	Decision

↳ **Business Rule** 638 *Import declaration type 'X' cannot be cancelled*

CARM Customs Declaration and Excise Documents Processing system (CDEPS)		REF: CDEPS_EXPORT_BPS
Business Process Specifications for EXPORT System		VER:410
↳ Business Rule	646	<i>Guarantees during the registration of Import declaration type 'X'</i>
↳ Business Rule	80	<i>Valid Message</i>
BPE1494. Is Declaration Amendment Accepted?	A decision point in the process to split the flow based on the validation results of the amendment request performed by the Customs Officer	Decision
BPE3765. Is it an electronic amendment request?	A decision point in the flow to navigate the process based on whether the amendment request is electronic or not	Decision
BPE3831. Declaration amendment request received by Customs Officer?	A decision point in the process to navigate the flow based on whether the Declaration amendment request was received by the Customs Officer or not	Decision

CARM Customs Declaration and Excise Documents Processing system (CDEPS)	REF: CDEPS_EXPORT_BPS
Business Process Specifications for EXPORT System	VER:410

1.6.2.BP0250. Validate Export

Business Process Description

The following table provides general information about the 'BP0250. Validate Export' process. The Business Process Diagram and the description of various business process elements are specified in the following paragraphs.

Description	Reusable subprocess that performs the message validation tasks for Export Regime.
Precondition(s)	None
Trigger	The process is triggered when an electronic message is received for validation.
Postcondition(s)	The validation is either completed successfully or with errors reported

Business Process Diagram

The Business Process Diagram of 'BP0250. Validate Export' is shown below in BPMN notation. The definition of a process that might be used as sub-process by the 'BP0250. Validate Export' can be found in this document. Finally, Annex A of CDEPS-BPS-EXPORT provides some explanatory information about the used notation.

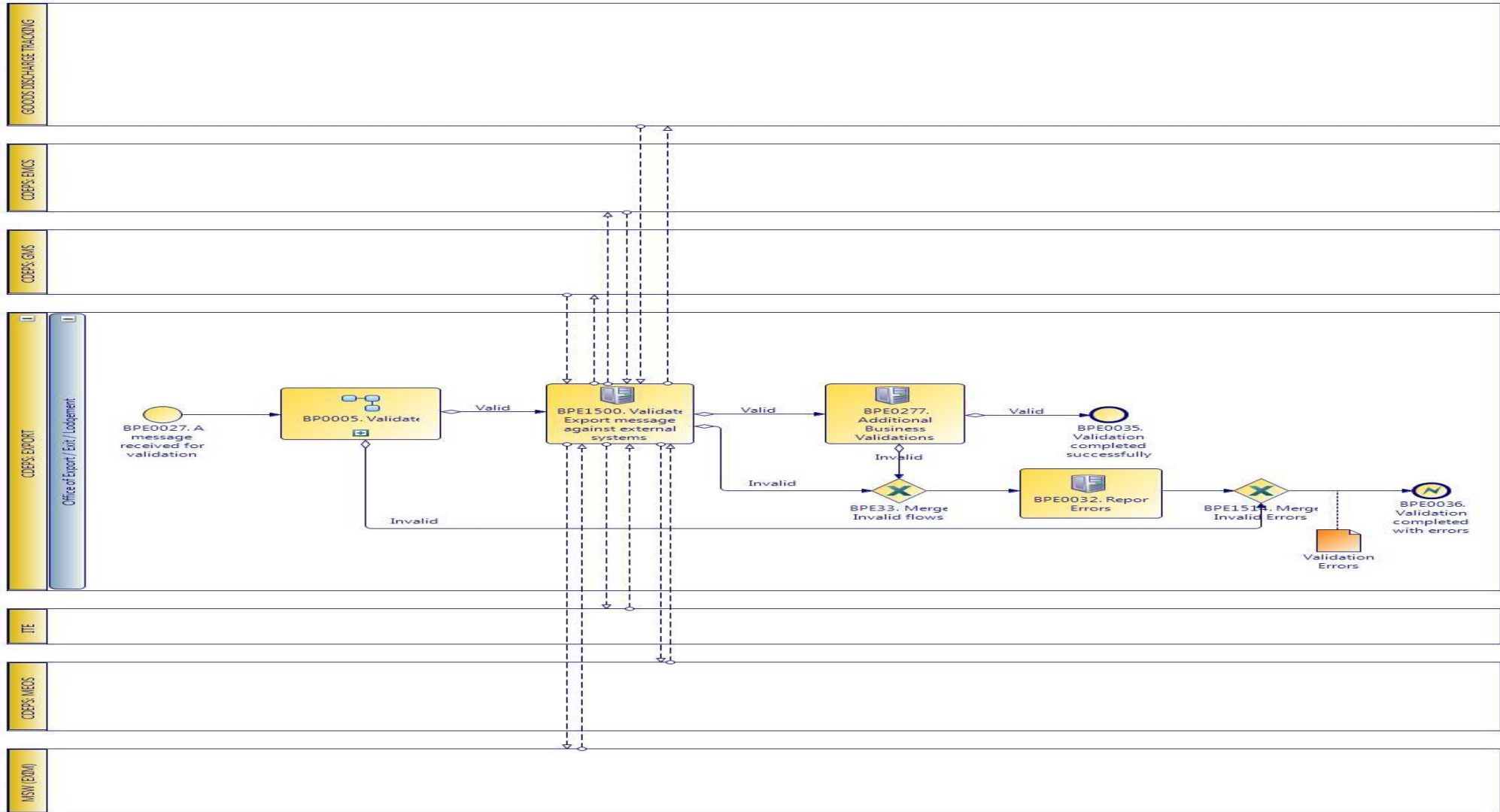

CARM Customs Declaration and Excise Documents Processing system (CDEPS)	REF: CDEPS_EXPORT_BPS
Business Process Specifications for EXPORT System	VER:410

1.6.2.1 Activities

The table below defines the 'Activities' of the 'BP0250. Validate Export' process.

Element Name	Description	Special Type
BPE0032. Report Errors	Report the identified errors from the validation process. The process terminates.	Service Task
BPE0277. Additional Business Validations for Export	The system performs any additional business validations specific to Export System.	Service Task
↳ Business Rule 19	Trader amending data same as Person lodging the declaration	
↳ Business Rule 21	Reject ENS/EXS amendment if ENS/EXS is not in appropriate state	
↳ Business Rule 245	Validate Personal ID	
↳ Business Rule 39	Cancellation Constraint	
↳ Business Rule 520	Import/ Export allowed guarantee types	
↳ Business Rule 70	EXS exists at the Office of Exit	
↳ Business Rule 71	Manifest number in IE547 and IE590	
BPE1500. Validate Export message against external systems	The system performs message validations against external systems.	Service Task
↳ Business Rule 101	Validate Economic Operator against MEOS	
↳ Business Rule 422	Validation of NCTS notifications	
↳ Business Rule 425	Goods Discharge required	
↳ Business Rule 439	Validate against GMS for integrity check	
↳ Business Rule 440	Validate Economic Operator's TIN against MEOS	
↳ Business Rule 494	Orchestrate validation of Export message against external systems	
↳ Business Rule 508	Validation of Export licenses with EXIM	

CARM Customs Declaration and Excise Documents Processing system (CDEPS)	REF: CDEPS_EXPORT_BPS
Business Process Specifications for EXPORT System	VER:410
↳ Business Rule 509	Check Export authorizations with MEOS
↳ Business Rule 51	Validate declared Combined Nomenclature in Declaration against ITE.
↳ Business Rule 510	Check Export authorizations for representation with MEOS
↳ Business Rule 511	Check Evidence of Power of Attorney with MEOS
↳ Business Rule 521	Validate Export declaration against ITE (duty calculation).
↳ Business Rule 522	Validate Export declaration data against Goods Discharge Tracking system
↳ Business Rule 527	Validate Export Declaration data against Excise system

1.6.2.2 Event(s)

The table below defines the 'Event(s)' of the 'BP0250. Validate Export' process.

Element Name	Description	Special Type
BPE0027. A message or event notification from GUI is received for validation	Message input in the validation process.	Start
BPE0035. Validation completed successfully	The validation is completed successfully with no errors reported. The process terminates.	End
BPE0036. Validation completed with errors	The validation completed with errors. The process terminates.	End

1.6.2.3 Gateway(s)

The table below defines the 'Gateway(s)' of the 'BP0250. Validate Export' process.

Element Name	Description	Special Type
BPE1514. Merge Invalid Errors	Combines exclusively either the negative outcome of generic validate process (BP0005. Validate) which reports errors or the errors from the extra checks for the specific system.	Merge

CARM Customs Declaration and Excise Documents Processing system (CDEPS)	REF: CDEPS_EXPORT_BPS
Business Process Specifications for EXPORT System	VER:410

1.6.3.BP0005. Validate

Business Process Description

The following table provides general information about the 'BP0005. Validate' process. The Business Process Diagram and the description of various business process elements are specified in the following paragraphs.

Description	Reusable subprocess that performs the message validation tasks
Precondition(s)	None
Trigger	The process is triggered when an electronic message is received for validation.
Postcondition(s)	

Business Process Diagram

The Business Process Diagram of 'BP0005. Validate' is shown below in BPMN notation. The definition of a process that might be used as sub-process by the 'BP0005. Validate' can be found in this document. Finally, Annex A of CDEPS-BPS-EXPORT provides some explanatory information about the used notation.

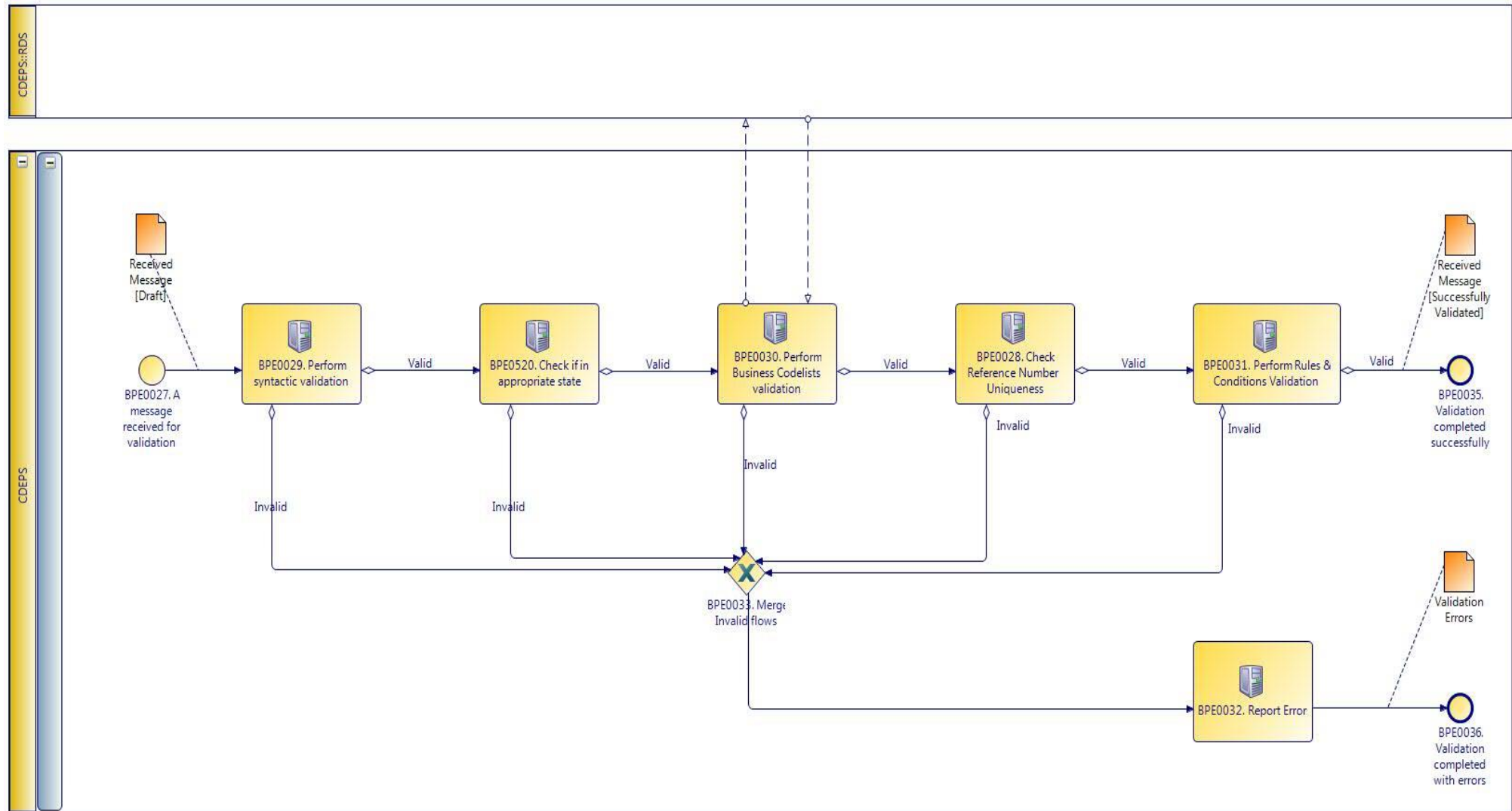

CARM Customs Declaration and Excise Documents Processing system (CDEPS)	REF: CDEPS_EXPORT_BPS
Business Process Specifications for EXPORT System	VER:410

1.6.3.1 Activities

The table below defines the 'Activities' of the 'BP0005. Validate' process.

Element Name	Description	Special Type
BPE0028. Check Reference Number Uniqueness	Check whether message reference numbers are unique in the system.	Service Task
↳ Business Rule 1	<i>Check Message Identification uniqueness</i>	
↳ Business Rule 74	<i>Check Local Reference Number (LRN) uniqueness</i>	
↳ Business Rule 75	<i>Check Movement Reference Number (MRN)uniqueness</i>	
↳ Business Rule 79	<i>Check Manifest reference number uniqueness</i>	
BPE0029. Perform syntactic validation	Check messages against the XSDs.	Service Task
↳ Business Rule 47	<i>Syntactic validation</i>	
BPE0030. Perform Business Codelists validation	Check the message business codelists.	Service Task
↳ Business Rule 50	<i>Business codelist validation against CDEPS:RDS</i>	
BPE0031. Perform Rules & Conditions Validation	Check the rules and conditions of the respective message.	Service Task
BPE0032. Report Errors	Report the identified errors from the validation process. The process terminates.	Service Task
BPE0520. Check if in appropriate state	Check whether the process for the particular entity (e.g. declaration/ application/ document) is on the appropriate state to process the received message. This check shall be performed based on the pertinent State Model of the system.	Service Task
↳ Business Rule 421	<i>Supplementary Declaration validation at Export</i>	
↳ Business Rule 448	<i>Check appropriate state for Export Declaration Amendment</i>	

CARM Customs Declaration and Excise Documents Processing system (CDEPS)	REF: CDEPS_EXPORT_BPS
Business Process Specifications for EXPORT System	VER:410

- ↳ **Business Rule** 449 *Check appropriate state Declaration Goods Presentation*
- ↳ **Business Rule** 468 *Guarantee Amendment*
- ↳ **Business Rule** 492 *Exit control results received at Export*
- ↳ **Business Rule** 493 *Export Declaration request at Export*

1.6.3.2 Event(s)

The table below defines the 'Event(s)' of the 'BP0005. Validate' process.

Element Name	Description	Special Type
BPE0027. A message or event notification from GUI is received for validation	Message input in the validation process.	Start
BPE0035. Validation completed successfully	The validation is completed successfully with no errors reported. The process terminates.	End
BPE0036. Validation completed with errors	The validation completed with errors. The process terminates.	End

1.6.3.3 Gateway(s)

The table below defines the 'Gateway(s)' of the 'BP0005. Validate' process.

Element Name	Description	Special Type
BPE0033. Merge Invalid Flows	Merge into exclusive event based gateway the invalid flows from all validation tasks.	Merge

CARM Customs Declaration and Excise Documents Processing system (CDEPS)	REF: CDEPS_EXPORT_BPS
Business Process Specifications for EXPORT System	VER:410

2. Process Category: Export Regime

2.1. Process Group: Export Declaration processing at Export

2.1.1.BP0137. Process Export Declaration @ Office of Export

Business Process Description

The following table provides general information about the 'BP0137. Process Export Declaration @ Office of Export' process. The Business Process Diagram and the description of various business process elements are specified in the following paragraphs.

Description	A high level process describing the actions performed by the system, starting with the registration of the Export declaration (electronic / paper) and ending with the release of the movement for Export.
Precondition(s)	None
Trigger	The process is triggered when the Export declaration, either via an electronic message, on paper or orally is received.
Postcondition(s)	<ul style="list-style-type: none"> - The Movement is not released for Export - The Movement is released for Export

Business Process Diagram

The Business Process Diagram of 'BP0137. Process Export Declaration @ Office of Export' is shown below in BPMN notation. The definition of a process that might be used as sub-process by the 'BP0137. Process Export Declaration @ Office of Export' can be found in this document. Finally, Annex A of CDEPS-BPS-EXPORT provides some explanatory information about the used notation.

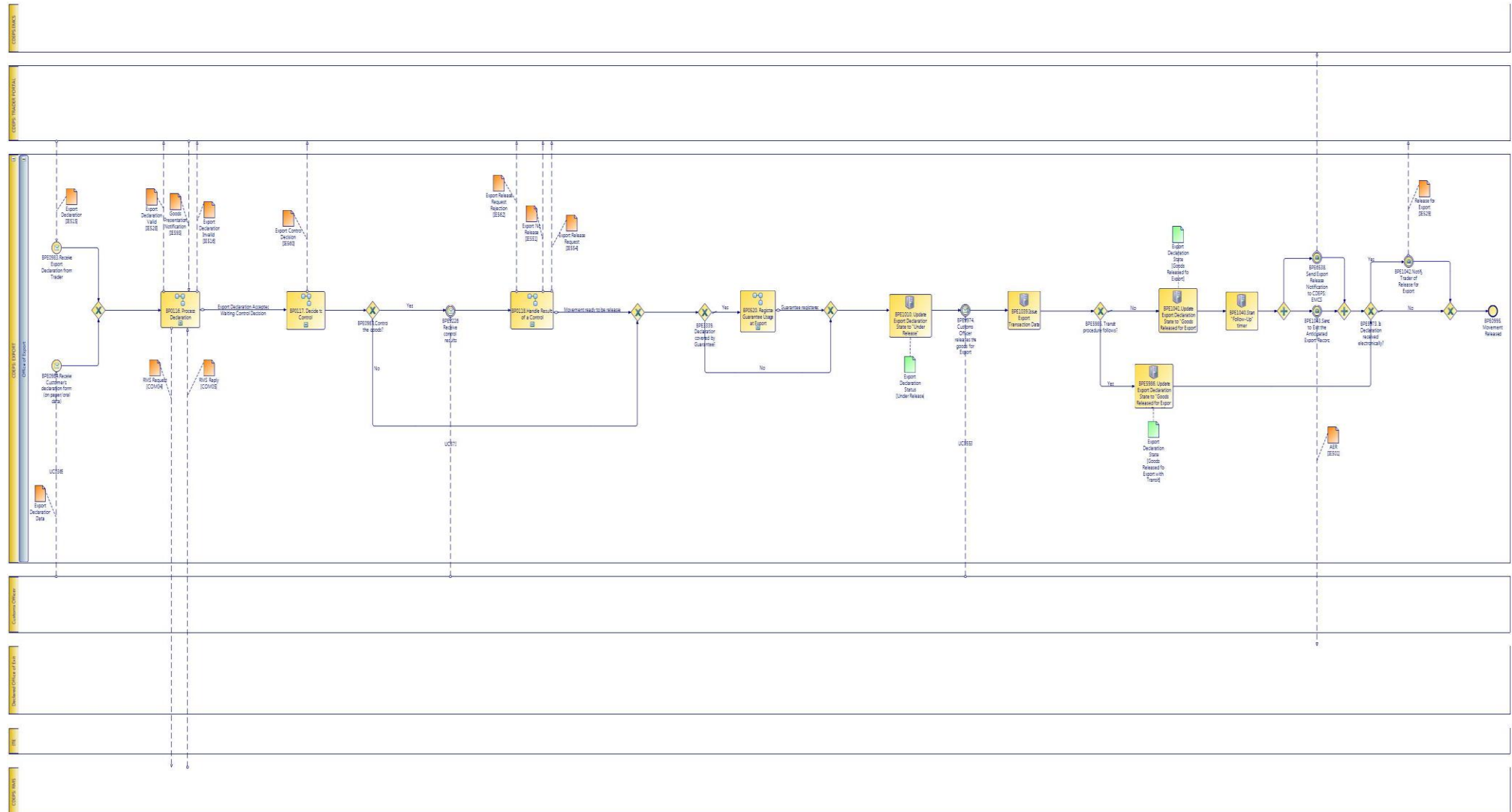

CARM Customs Declaration and Excise Documents Processing system (CDEPS)	REF: CDEPS_EXPORT_BPS
Business Process Specifications for EXPORT System	VER:410

2.1.1.1 Activities

The table below defines the 'Activities' of the 'BP0137. Process Export Declaration @ Office of Export' process.

Element Name	Description	Special Type
BPE1010. Update Export Declaration State to 'Under Release'	The system updates the Export declaration state to 'Under Release'.	Service Task
BPE1039. Issue Export Transaction Data	The system issues the release of the export declaration upon the calculation of the duties and taxes.	Service Task
BPE1040. Start "Follow-Up" timer	The "Follow-Up" timer is set to allocate the time for the receipt of the Exit confirmation.	Service Task
BPE1041. Update Export Declaration State to "Goods Released for Export"	The system updates the state of the declaration to "Goods Released for Export" upon the release of the movement for export.	Service Task

2.1.1.2 Event(s)

The table below defines the 'Event(s)' of the 'BP0137. Process Export Declaration @ Office of Export' process.

Element Name	Description	Special Type
BPE0983. Receive Export Declaration from Trader	The Office of Export receives the Export Declaration submitted electronically by the Trader.	Start
BPE0984. Receive Customer's declaration form on paper	The system receives the Customs Officer's declaration form on paper or oral form.	Start
BPE0995. Movement Released	The movement is released for export either followed by Transit or not and the process terminates.	End
BPE1042. Notify Trader of Release for Export	The Office of Export notifies the Trader of the export release of the goods.	Intermediate

CARM Customs Declaration and Excise Documents Processing system (CDEPS)	REF: CDEPS_EXPORT_BPS
Business Process Specifications for EXPORT System	VER:410

BPE1043. Send the Anticipated Export Record to Exit	The Office of Export sends the Anticipated Export record to the Office of Exit	Intermediate
BPE5974. Customs Officer releases the goods for Export	The customs officer release for export the goods of the declaration (NP)	Intermediate
BPE6538. Send Export Release Notification to CDEPS: EMCS	The system sends to CDEPS: EMCS the notification for the release of the Export Declaration.	Intermediate

2.1.1.3 Gateway(s)

The table below defines the 'Gateway(s)' of the 'BP0137. Process Export Declaration @ Office of Export' process.

Element Name	Description	Special Type
BPE0987. Control the goods?	A decision point on the flow to decide whether the goods will be controlled or not.	Decision
BPE3339. Declaration covered by Guarantee?	A decision point in the process to navigate the flow based on whether the declaration is secured or not	Decision
↳ Business Rule	613 <i>Guarantee type '5' or '8'</i>	
BPE5973. Is Declaration received electronically?	A decision point in the process to navigate the flows based on whether the declartion is received electronically or on paper.	Decision

CARM Customs Declaration and Excise Documents Processing system (CDEPS)	REF: CDEPS_EXPORT_BPS
Business Process Specifications for EXPORT System	VER:410

2.1.2.BP0908. Manual Release of Guarantees

Business Process Description

The following table provides general information about the 'BP0908. Manual Release of Guarantees' process. The Business Process Diagram and the description of various business process elements are specified in the following paragraphs.

Description	The process describes the custom's officer request to release a specific amount from one or more than one guarantee(s).
Precondition(s)	Guarantee(s) are registered.
Trigger	Customs officer decision
Postcondition(s)	-Nothing -Release amount from guarantee

Business Process Diagram

The Business Process Diagram of 'BP0908. Manual Release of Guarantees' is shown below in BPMN notation. The definition of a process that might be used as sub-process by the 'BP0908. Manual Release of Guarantees' can be found in this document. Finally, Annex A of CDEPS-BPS-EXPORT provides some explanatory information about the used notation.

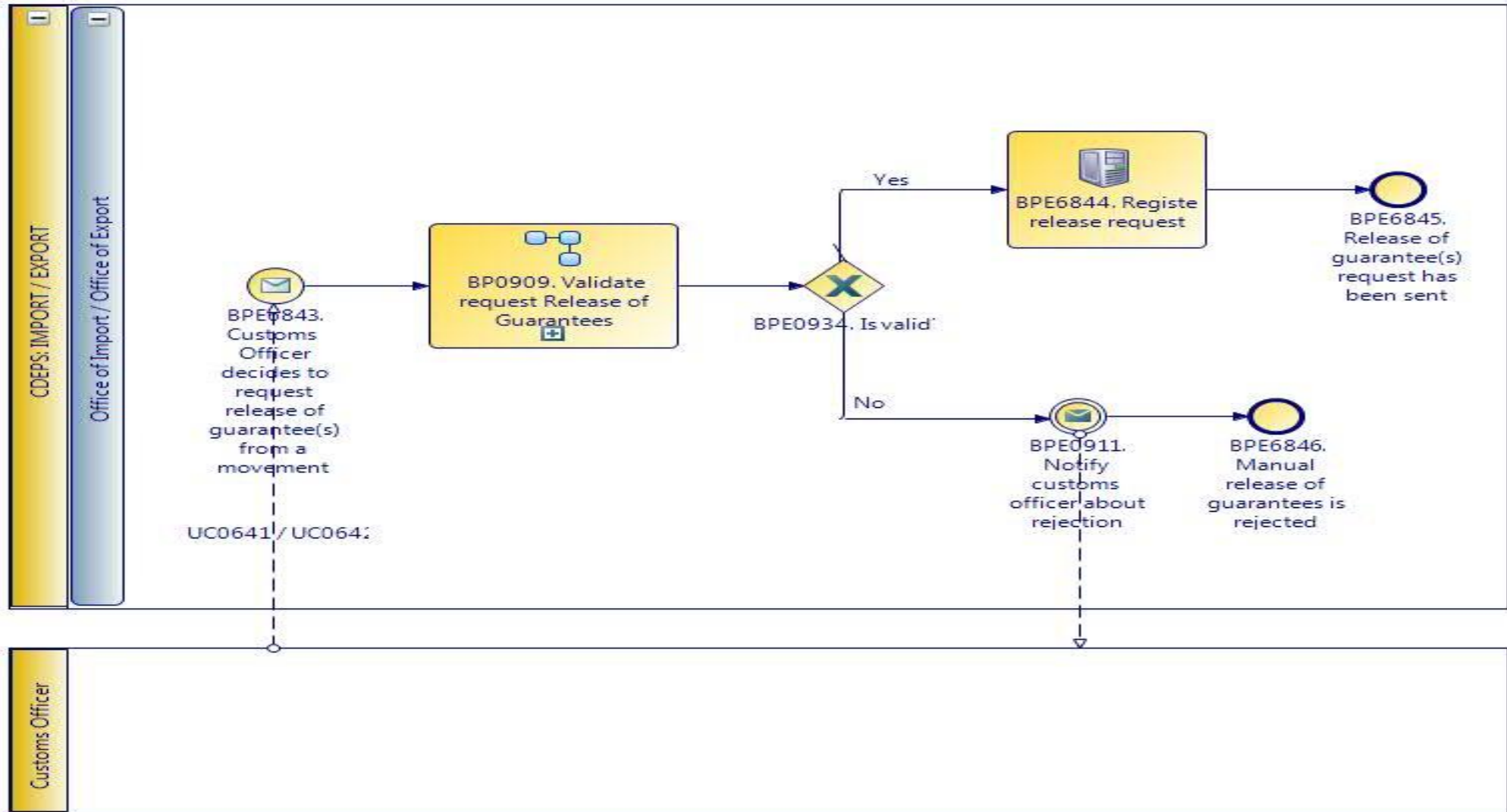

CARM Customs Declaration and Excise Documents Processing system (CDEPS)	REF: CDEPS_EXPORT_BPS
Business Process Specifications for EXPORT System	VER:410

2.1.2.1 Activities

The table below defines the 'Activities' of the 'BP0908. Manual Release of Guarantees' process.

Element Name	Description	Special Type
BPE6844. Register release of guarantee(s) request	The system registers the release of guarantee(s) request by the CO.	Service Task

2.1.2.2 Event(s)

The table below defines the 'Event(s)' of the 'BP0908. Manual Release of Guarantees' process.

Element Name	Description	Special Type
BPE0911. Notify customs officer about rejection	The Customs Officer is notified about the rejection of the request due to its invalidation.	End
BPE6843. Customs Officer decides to request release of guarantee(s) from a movement	An authorized customs officer decides to request release of guarantee(s) from a movement.	Start
BPE6845. Release of guarantee(s) request has been sent	Release of guarantee(s) request has been sent.	End
BPE6846. Manual release of guarantees is rejected	Manual release of guarantees is rejected.	End

2.1.2.3 Gateway(s)

The table below defines the 'Gateway(s)' of the 'BP0908. Manual Release of Guarantees' process.

Element Name	Description	Special Type
BPE0934. Is Valid?	A decision point in the process to navigate the flow based on the message validation result.	Decision

↳ **Business Rule** 638 *Import declaration type 'X' cannot be cancelled*

CARM Customs Declaration and Excise Documents Processing system (CDEPS)	REF: CDEPS_EXPORT_BPS
Business Process Specifications for EXPORT System	VER:410
↳ Business Rule 646	<i>Guarantees during the registration of Import declaration type 'X'</i>
↳ Business Rule 80	<i>Valid Message</i>

CARM Customs Declaration and Excise Documents Processing system (CDEPS)	REF: CDEPS_EXPORT_BPS
Business Process Specifications for EXPORT System	VER:410

2.1.3.BP0909. Validate request Release of Guarantees

Business Process Description

The following table provides general information about the 'BP0909. Validate request Release of Guarantees' process. The Business Process Diagram and the description of various business process elements are specified in the following paragraphs.

Description	Validate request Release of Guarantees
Precondition(s)	
Trigger	
Postcondition(s)	

Business Process Diagram

The Business Process Diagram of 'BP0909. Validate request Release of Guarantees' is shown below in BPMN notation. The definition of a process that might be used as sub-process by the 'BP0909. Validate request Release of Guarantees' can be found in this document. Finally, Annex A of CDEPS-BPS-EXPORT provides some explanatory information about the used notation.

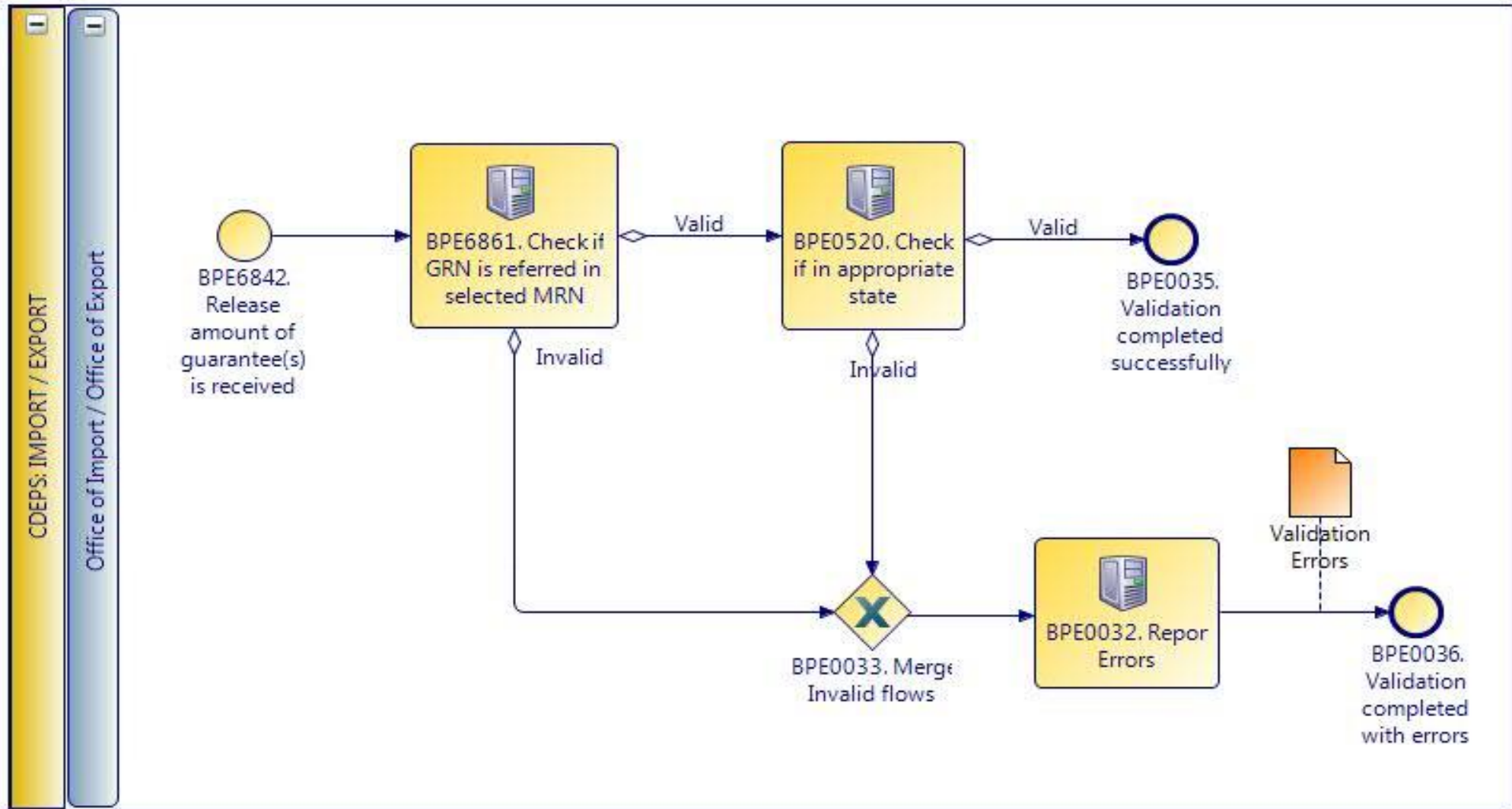

CARM Customs Declaration and Excise Documents Processing system (CDEPS)	REF: CDEPS_EXPORT_BPS
Business Process Specifications for EXPORT System	VER:410

2.1.3.1 Activities

The table below defines the 'Activities' of the 'BP0909. Validate request Release of Guarantees' process.

Element Name	Description	Special Type
BPE0032. Report Errors	Report the identified errors from the validation process. The process terminates.	Service Task
BPE0520. Check if in appropriate state	Check whether the process for the particular entity (e.g. declaration/ application/ document) is on the appropriate state to process the received message. This check shall be performed based on the pertinent State Model of the system.	Service Task
↳ Business Rule 421	<i>Supplementary Declaration validation at Export</i>	
↳ Business Rule 448	<i>Check appropriate state for Export Declaration Amendment</i>	
↳ Business Rule 449	<i>Check appropriate state Declaration Goods Presentation</i>	
↳ Business Rule 468	<i>Guarantee Amendment</i>	
↳ Business Rule 492	<i>Exit control results received at Export</i>	
↳ Business Rule 493	<i>Export Declaration request at Export</i>	
BPE6861. Check if GRN is referred in selected MRN	Check if GRN is referred in selected MRN	Service Task
↳ Business Rule 615	<i>Check appropriate procedures</i>	

2.1.3.2 Event(s)

The table below defines the 'Event(s)' of the 'BP0909. Validate request Release of Guarantees' process.

Element Name	Description	Special Type
BPE0035. Validation completed successfully	The validation is completed successfully with no errors reported. The process terminates.	End
BPE0036. Validation completed with errors	The validation completed with errors. The process terminates.	End

CARM Customs Declaration and Excise Documents Processing system (CDEPS)	REF: CDEPS_EXPORT_BPS
Business Process Specifications for EXPORT System	VER:410

BPE6842. Release amount from guarantee(s) is received Start

2.1.3.3 Gateway(s)

The table below defines the 'Gateway(s)' of the 'BP0909. Validate request Release of Guarantees' process.

Element Name	Description	Special Type
BPE0033. Merge Invalid Flows	Merge into exclusive event based gateway the invalid flows from all validation tasks.	Merge

CARM Customs Declaration and Excise Documents Processing system (CDEPS)	REF: CDEPS_EXPORT_BPS
Business Process Specifications for EXPORT System	VER:410

2.1.4.BP0116. Process Declaration

Business Process Description

The following table provides general information about the 'BP0116. Process Declaration' process. The Business Process Diagram and the description of various business process elements are specified in the following paragraphs.

Description	Reusable subprocess that describes the tasks performed by the system in order to process the received Export declaration including the validation, the notification of relevant parties and the risk analysis results till it is finally accepted or rejected.
Precondition(s)	Export Declaration (electronic/on paper/ oral) has been received)
Trigger	The process is triggered when the Export Declaration (electronic/on paper/ oral) is received
Postcondition(s)	<ul style="list-style-type: none"> - None - Rejected - Waiting for Control Decision

Business Process Diagram

The Business Process Diagram of 'BP0116. Process Declaration' is shown below in BPMN notation. The definition of a process that might be used as sub-process by the 'BP0116. Process Declaration' can be found in this document. Finally, Annex A of CDEPS-BPS-EXPORT provides some explanatory information about the used notation.

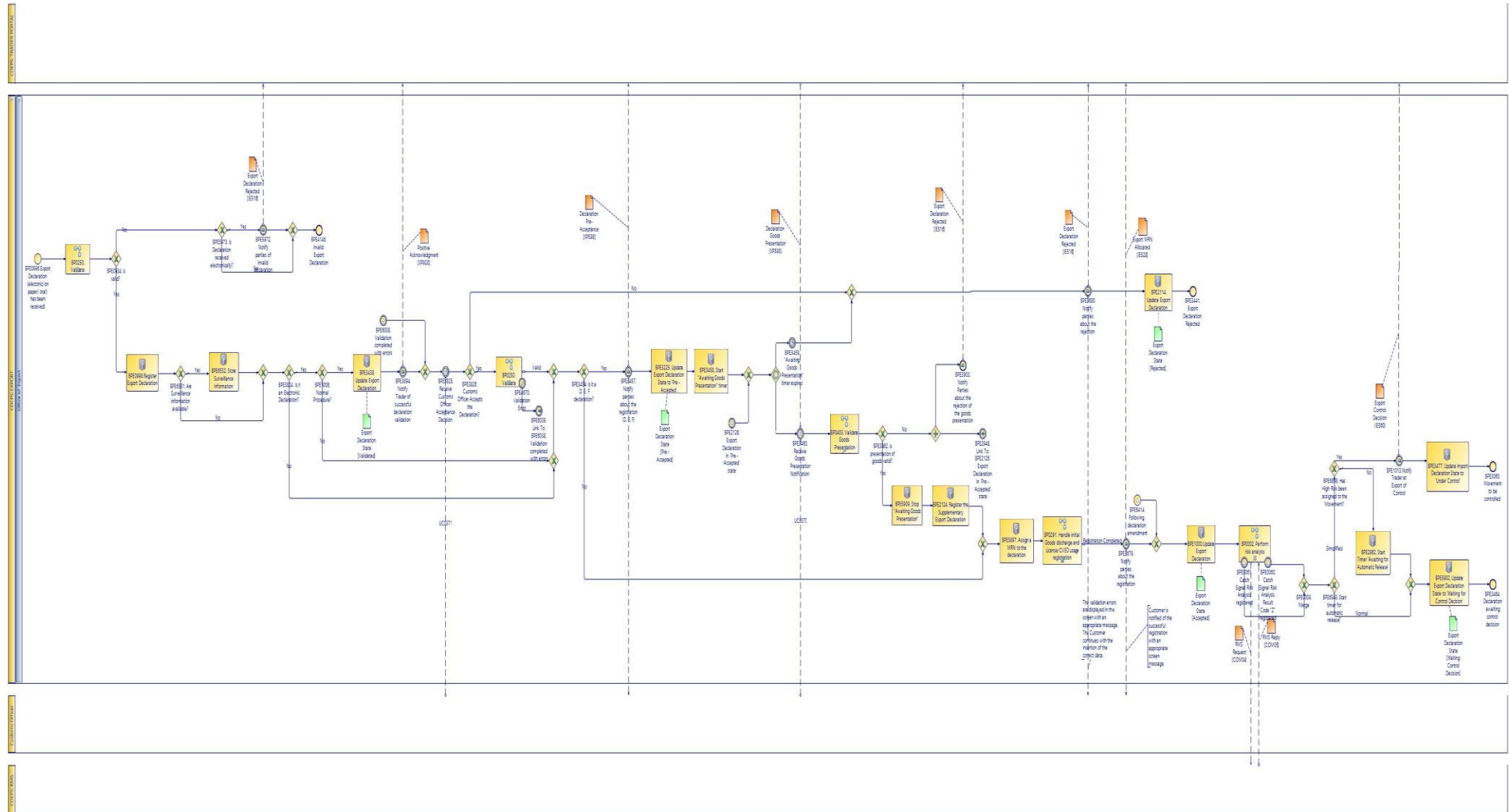

CARM Customs Declaration and Excise Documents Processing system (CDEPS)	REF: CDEPS_EXPORT_BPS
Business Process Specifications for EXPORT System	VER:410

2.1.4.1 Activities

The table below defines the 'Activities' of the 'BP0116. Process Declaration' process.

Element Name	Description	Special Type
BPE0998. Register Export Declaration	The validated export declaration received from either the Trader or the Customs Officer is finally registered in the system	Service Task
BPE1000. Update Export Declaration State to 'Accepted'	The system updates the declaration state to 'Accepted'	Service Task
BPE1090. Update Export Declaration State to 'Cancelled'	The system updated the Export Declaration State to 'Cancelled'	Service Task
BPE2114. Update Export Declaration State to 'Rejected'	The system updates the state of the Export Declaration to 'Rejected'	Service Task
BPE2124. Register the Goods Presentation Notification	The system registers the Supplementary Export declaration	Service Task
BPE2962. Start Timer 'Awaiting for Automatic Release'	System initiates the 'Awaiting for Automatic Release' timer	Service Task
↳ Business Rule 498	Timer 'Awaiting for Automatic Release'	
BPE3225. Update Export Declaration State to 'Pre - Accepted'	The system updates the Export Declaration State to 'Pre - Accepted'	Service Task
BPE3438. Update Export Declaration State to 'Validated'	The system updates the Export Declaration State to 'Validated'	Service Task

CARM Customs Declaration and Excise Documents Processing system (CDEPS)	REF: CDEPS_EXPORT_BPS
Business Process Specifications for EXPORT System	VER:410

BPE3458. Start "Awaiting Goods Presentation" timer	The "Awaiting Goods Presentation" timer starts	Service Task
BPE3477. Update Import Declaration State to 'Under Control'	The system updates the import declaration state to 'Under Control'	Service Task
BPE5897. Assign a MRN to the declaration	The system assigns the MRN to the declaration upon its acceptance	Service Task
↳ Business Rule 253	<i>Movement Reference Number (MRN) Structure</i>	
BPE5902. Update Export Declaration State to 'Waiting for Control Decision'	The system updates the Export Declaration State to 'Waiting for Control Decision'	Service Task
BPE5909. Stop "Awaiting Goods Presentation" timer	Upon reception of goods presentation the "Awaiting Goods Presentation" timer is stopped	Service Task
BPE6552. Store Surveillance Information	The system stores the available Surveillance Information	Service Task

2.1.4.2 Event(s)

The table below defines the 'Event(s)' of the 'BP0116. Process Declaration' process.

Element Name	Description	Special Type
BPE0061. Catch Signal Risk Analysis registered	Catch Signal Risk Analysis registered (RiskAnalysisCompletedOK).	Intermediate
BPE0993. Invalid electronic Export Declaration	The Export Declaration is invalidated and the process terminates	End

CARM Customs Declaration and Excise Documents Processing system (CDEPS)	REF: CDEPS_EXPORT_BPS
Business Process Specifications for EXPORT System	VER:410

BPE0996. Export Declaration (electronic/on paper/ oral) has been received	The export declaration has been received and the process begins.	Start
BPE1005. Export Declaration Accepted	The export declaration is accepted and the process terminates.	End
BPE1013. Notify Trader at Export of Control	The system notifies the Trader of the decision to perform control at Export.	Intermediate
BPE2092. Notify parties of the expiration of the timer	The parties are notified of the expiration of the "Supplementary Export Declaration" timer	Intermediate
BPE2126. Export Declaration in 'Pre - Accepted' state	Export Declaration in 'Pre - Accepted' state	Intermediate
BPE2353. Receive Supplementary Export Declaration	The system receives the Supplementary Export Declaration	Intermediate
BPE2948. Link To: BPE2126. Export Declaration in 'Pre - Accepted' state	Link To: BPE2126. Export Declaration in 'Pre - Accepted' state	Intermediate
BPE3060. Movement to be controlled	Movement to be controlled	End
BPE3075. Movement has been cancelled	Movement has been cancelled	End
BPE3441. Export Declaration Rejected	The Export Declaration is rejected and the process terminates	End
BPE3450. Request guarantee integrity check	The system requests from CDEPS: GMS to check the integrity of the Guarantee	Intermediate

CARM Customs Declaration and Excise Documents Processing system (CDEPS)		REF: CDEPS_EXPORT_BPS
Business Process Specifications for EXPORT System		VER:410
BPE3451. Receive Guarantee Integrity check results	The system receives the results of the guarantee integrity	Intermediate
BPE3457. Notify parties about the registration (D, E, F)	The system notifies the parties about the successful registration of the declaration type D, E or F	Intermediate
BPE3459. "Awaiting Goods Presentation" timer expires	The "Awaiting Goods Presentation" timer expires	Intermediate
↳ Business Rule	186	<i>Start / End day of Timers</i>
BPE3460. Receive Goods Presentation Notification	The system receives the Receive Goods Presentation Notification	Intermediate
BPE3464. Declaration awaiting control decision	Declaration awaiting control decision	End
BPE3679. Notify parties about the registration	Upon the validation of the Declaration data the parties are notified of the successful registration	Intermediate
BPE3680. Notify parties about the rejection	Upon the invalidation of the Declaration data the parties are notified of the rejection	Intermediate
BPE3864. Incomplete declaration	The declaration is incomplete and the process awaits for the reception of the supplementary declaration.	Intermediate
BPE3894. Notify Trader of successful declaration validation	The system notifies the Trader of the successful validation of the declaration	Intermediate
BPE3903. Notify Parties about the rejection of the goods presentation	Notify Parties about the rejection of the goods presentation	End
BPE4146. Invalid Export Declaration	The Export Declaration is invalidated and the process terminates	End

CARM Customs Declaration and Excise Documents Processing system (CDEPS)	REF: CDEPS_EXPORT_BPS
Business Process Specifications for EXPORT System	VER:410

BPE4670. Validation Error	The reusable process throws an error.	Intermediate
BPE0060. Catch Signal Risk Analysis Result Code "Z" registered	Catch Signal Risk Analysis Result Code "Z" registered (RiskAnalysisZ)	Intermediate
BPE5972. Notify parties of invalid declaration	Parties are notified of invalid declaration	Intermediate
BPE6038. Validation completed with errors	A throw link in the process navigating the flow when the validation errors are reported	Intermediate
BPE6039. Link To: BPE6038. Validation completed with errors	An intermediate event in the process linked to: BPE6038. Validation completed with errors	Intermediate
BPE6414. Following declaration amendment	Following declaration amendment	Start

2.1.4.3 Gateway(s)

The table below defines the 'Gateway(s)' of the 'BP0116. Process Declaration' process.

Element Name	Description	Special Type
BPE0059. Merge	Merge risk analysis completion signals	Merge
BPE0934. Is Valid?	A decision point in the process to navigate the flow based on the message validation result.	Decision
↳ Business Rule	638 <i>Import declaration type 'X' cannot be cancelled</i>	
↳ Business Rule	646 <i>Guarantees during the registration of Import declaration type 'X'</i>	
↳ Business Rule	80 <i>Valid Message</i>	
BPE1006. Normal Procedure?	A decision point in the process to split the flow based on whether it is a normal or simplified procedure.	Decision
↳ Business Rule	386 <i>Normal Procedure Declaration</i>	

CARM Customs Declaration and Excise Documents Processing system (CDEPS)		REF: CDEPS_EXPORT_BPS
Business Process Specifications for EXPORT System		VER:410
BPE3453. Is guarantee valid?	A decision point in the process to navigate the flow based on whether the guarantee is valid based on the guarantee integrity results	Decision
BPE3454. Is it a D, E, F declaration?	A decision point in the process to navigate the flow based on the declaration type	Decision
BPE3824. Is it an Electronic Declaration?	A decision point in the process to navigate the flow based on whether the declaration is electronic or not	Decision
BPE3825. Receive Customs Officer Acceptance Decision	The system receives Customs Officer acceptance/rejection of the declaration	Decision
BPE3826. Customs Officer Accepts the Declaration?	A decision point in the process to navigate the flow based on whether the declaration is accepted or not	Decision
BPE3862. Is presentation valid?	A decision point in the process to navigate the flow based on the whether the supplementary declaration is valid or not	Decision
↳ Business Rule 428	<i>Presentation of Goods</i>	
BPE3863. Is declaration complete?	A decision point in the process to navigate the flow based on whether the declaration is complete or not upon the submission of the supplementary declaration	Decision
BPE5973. Is Declaration received electronically?	A decision point in the process to navigate the flows based on whether the declaration is received electronically or on paper.	Decision
BPE6543. Start timer for automatic release?	A decision point in the process to navigate the flow based on whether the timer for the automatic release should be set.	Decision
↳ Business Rule 498	<i>Timer 'Awaiting for Automatic Release'</i>	
BPE6551. Are Surveillance information available?	A decision point in the process to navigate the flow based on whether surveillance information is received from ITE.	Decision
BPE6898. Has High Risk been assigned to the Movement?	This is a gateway that checks whether the risk assigned to the movement is high or not.	Decision

CARM Customs Declaration and Excise Documents Processing system (CDEPS)	REF: CDEPS_EXPORT_BPS
Business Process Specifications for EXPORT System	VER:410

2.1.5.BP0250. Validate Export

Business Process Description

The following table provides general information about the 'BP0250. Validate Export' process. The Business Process Diagram and the description of various business process elements are specified in the following paragraphs.

Description	Reusable subprocess that performs the message validation tasks for Export Regime.
Precondition(s)	None
Trigger	The process is triggered when an electronic message is received for validation.
Postcondition(s)	The validation is either completed successfully or with errors reported

Business Process Diagram

The Business Process Diagram of 'BP0250. Validate Export' is shown below in BPMN notation. The definition of a process that might be used as sub-process by the 'BP0250. Validate Export' can be found in this document. Finally, Annex A of CDEPS-BPS-EXPORT provides some explanatory information about the used notation.

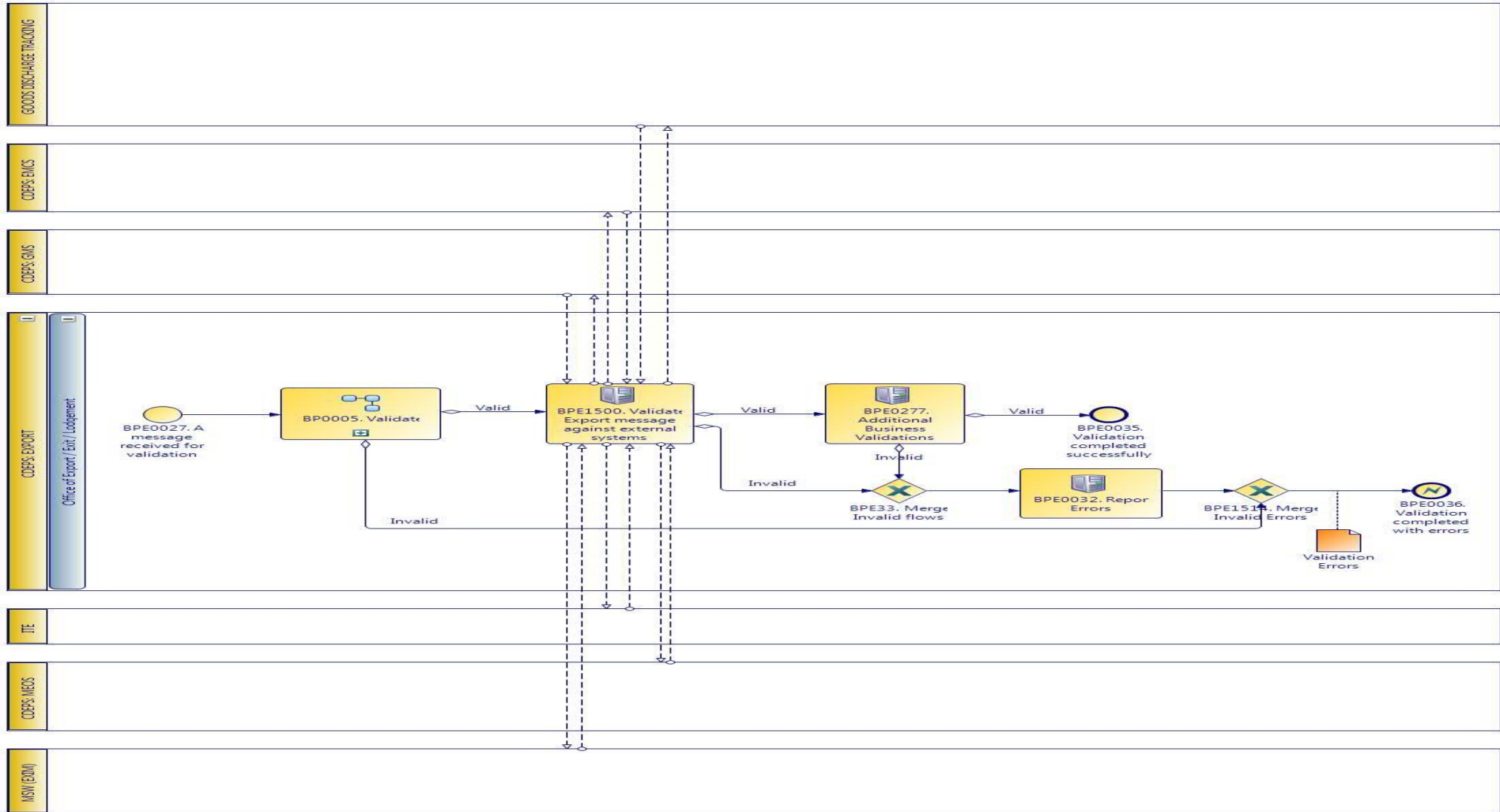

CARM Customs Declaration and Excise Documents Processing system (CDEPS)	REF: CDEPS_EXPORT_BPS
Business Process Specifications for EXPORT System	VER:410

2.1.5.1 Activities

The table below defines the 'Activities' of the 'BP0250. Validate Export' process.

Element Name	Description	Special Type
BPE0032. Report Errors	Report the identified errors from the validation process. The process terminates.	Service Task
BPE0277. Additional Business Validations for Export	The system performs any additional business validations specific to Export System.	Service Task
↳ Business Rule 19	Trader amending data same as Person lodging the declaration	
↳ Business Rule 21	Reject ENS/EXS amendment if ENS/EXS is not in appropriate state	
↳ Business Rule 245	Validate Personal ID	
↳ Business Rule 39	Cancellation Constraint	
↳ Business Rule 520	Import/ Export allowed guarantee types	
↳ Business Rule 70	EXS exists at the Office of Exit	
↳ Business Rule 71	Manifest number in IE547 and IE590	
BPE1500. Validate Export message against external systems	The system performs message validations against external systems.	Service Task
↳ Business Rule 101	Validate Economic Operator against MEOS	
↳ Business Rule 422	Validation of NCTS notifications	
↳ Business Rule 425	Goods Discharge required	
↳ Business Rule 439	Validate against GMS for integrity check	
↳ Business Rule 440	Validate Economic Operator's TIN against MEOS	
↳ Business Rule 494	Orchestrate validation of Export message against external systems	
↳ Business Rule 508	Validation of Export licenses with EXIM	

CARM Customs Declaration and Excise Documents Processing system (CDEPS)	REF: CDEPS_EXPORT_BPS
Business Process Specifications for EXPORT System	VER:410
↳ Business Rule 509	Check Export authorizations with MEOS
↳ Business Rule 51	Validate declared Combined Nomenclature in Declaration against ITE.
↳ Business Rule 510	Check Export authorizations for representation with MEOS
↳ Business Rule 511	Check Evidence of Power of Attorney with MEOS
↳ Business Rule 521	Validate Export declaration against ITE (duty calculation).
↳ Business Rule 522	Validate Export declaration data against Goods Discharge Tracking system
↳ Business Rule 527	Validate Export Declaration data against Excise system

2.1.5.2 Event(s)

The table below defines the 'Event(s)' of the 'BP0250. Validate Export' process.

Element Name	Description	Special Type
BPE0027. A message or event notification from GUI is received for validation	Message input in the validation process.	Start
BPE0035. Validation completed successfully	The validation is completed successfully with no errors reported. The process terminates.	End
BPE0036. Validation completed with errors	The validation completed with errors. The process terminates.	End

2.1.5.3 Gateway(s)

The table below defines the 'Gateway(s)' of the 'BP0250. Validate Export' process.

Element Name	Description	Special Type
BPE1514. Merge Invalid Errors	Combines exclusively either the negative outcome of generic validate process (BP0005. Validate) which reports errors or the errors from the extra checks for the specific system.	Merge

CARM Customs Declaration and Excise Documents Processing system (CDEPS)	REF: CDEPS_EXPORT_BPS
Business Process Specifications for EXPORT System	VER:410

2.1.6.BP0403. Validate Goods Presentation Notification

Business Process Description

The following table provides general information about the 'BP0403. Validate Goods Presentation Notification' process. The Business Process Diagram and the description of various business process elements are specified in the following paragraphs.

Description	Reusable subprocess that performs the validation tasks for the Goods Presentation Notification received at the Office of Export.
Precondition(s)	None
Trigger	The process is triggered when an electronic message is received for validation.
Postcondition(s)	The validation is either completed successfully or with errors reported

Business Process Diagram

The Business Process Diagram of 'BP0403. Validate Goods Presentation Notification' is shown below in BPMN notation. The definition of a process that might be used as sub-process by the 'BP0403. Validate Goods Presentation Notification' can be found in this document. Finally, Annex A of CDEPS-BPS-EXPORT provides some explanatory information about the used notation.

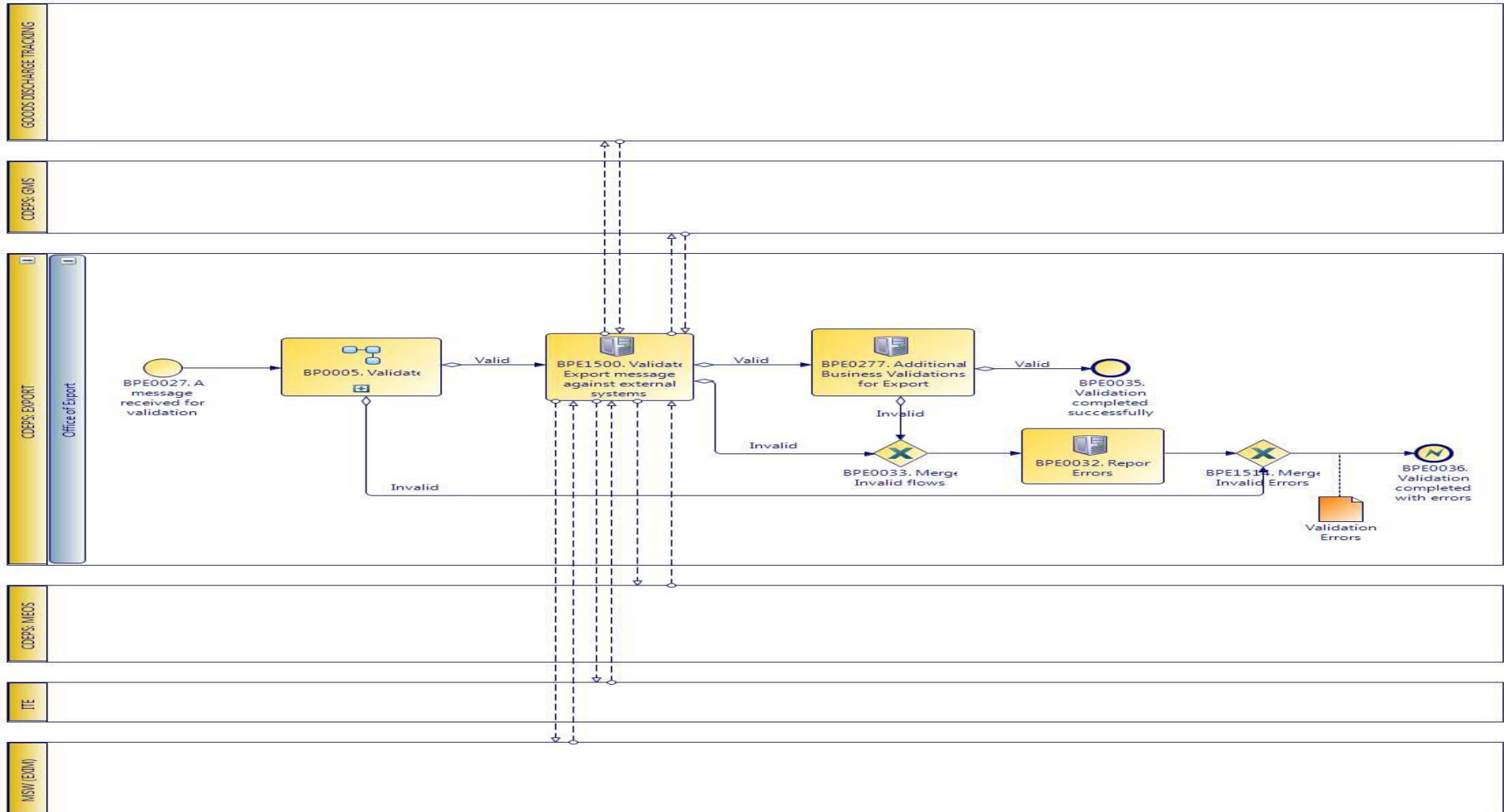

CARM Customs Declaration and Excise Documents Processing system (CDEPS)	REF: CDEPS_EXPORT_BPS
Business Process Specifications for EXPORT System	VER:410

2.1.6.1 Activities

The table below defines the 'Activities' of the 'BP0403. Validate Goods Presentation Notification' process.

Element Name	Description	Special Type
BPE0032. Report Errors	Report the identified errors from the validation process. The process terminates.	Service Task
BPE0277. Additional Business Validations for Export	The system performs any additional business validations specific to Export System.	Service Task
↳ Business Rule 19	Trader amending data same as Person lodging the declaration	
↳ Business Rule 21	Reject ENS/EXS amendment if ENS/EXS is not in appropriate state	
↳ Business Rule 245	Validate Personal ID	
↳ Business Rule 39	Cancellation Constraint	
↳ Business Rule 520	Import/ Export allowed guarantee types	
↳ Business Rule 70	EXS exists at the Office of Exit	
↳ Business Rule 71	Manifest number in IE547 and IE590	
BPE1500. Validate Export message against external systems	The system performs message validations against external systems.	Service Task
↳ Business Rule 101	Validate Economic Operator against MEOS	
↳ Business Rule 422	Validation of NCTS notifications	
↳ Business Rule 425	Goods Discharge required	
↳ Business Rule 439	Validate against GMS for integrity check	
↳ Business Rule 440	Validate Economic Operator's TIN against MEOS	
↳ Business Rule 494	Orchestrate validation of Export message against external systems	
↳ Business Rule 508	Validation of Export licenses with EXIM	

CARM Customs Declaration and Excise Documents Processing system (CDEPS)	REF: CDEPS_EXPORT_BPS
Business Process Specifications for EXPORT System	VER:410
↳ Business Rule 509	Check Export authorizations with MEOS
↳ Business Rule 51	Validate declared Combined Nomenclature in Declaration against ITE.
↳ Business Rule 510	Check Export authorizations for representation with MEOS
↳ Business Rule 511	Check Evidence of Power of Attorney with MEOS
↳ Business Rule 521	Validate Export declaration against ITE (duty calculation).
↳ Business Rule 522	Validate Export declaration data against Goods Discharge Tracking system
↳ Business Rule 527	Validate Export Declaration data against Excise system

2.1.6.2 Event(s)

The table below defines the 'Event(s)' of the 'BP0403. Validate Goods Presentation Notification' process.

Element Name	Description	Special Type
BPE0027. A message or event notification from GUI is received for validation	Message input in the validation process.	Start
BPE0035. Validation completed successfully	The validation is completed successfully with no errors reported. The process terminates.	End
BPE0036. Validation completed with errors	The validation completed with errors. The process terminates.	End

2.1.6.3 Gateway(s)

The table below defines the 'Gateway(s)' of the 'BP0403. Validate Goods Presentation Notification' process.

Element Name	Description	Special Type
BPE0033. Merge Invalid Flows	Merge into exclusive event based gateway the invalid flows from all validation tasks.	Merge
BPE1514. Merge Invalid Errors	Combines exclusively either the negative outcome of generic validate process (BP0005. Validate) which reports errors or the errors from the extra checks for the specific system.	Merge

CARM Customs Declaration and Excise Documents Processing system (CDEPS)	REF: CDEPS_EXPORT_BPS
Business Process Specifications for EXPORT System	VER:410

2.1.7.BP0117. Decide to Control

Business Process Description

The following table provides general information about the 'BP0117. Decide to Control' process. The Business Process Diagram and the description of various business process elements are specified in the following paragraphs.

Description	Reusable subprocess that describes the tasks performed by the system in order to finalize the decision of control or no control of the Export declaration.
Precondition(s)	Accepted
Trigger	The process is triggered when the declaration is accepted and the Customs Officer takes the decision to control or not
Postcondition(s)	- Under Release - Under Control

Business Process Diagram

The Business Process Diagram of 'BP0117. Decide to Control' is shown below in BPMN notation. The definition of a process that might be used as sub-process by the 'BP0117. Decide to Control' can be found in this document. Finally, Annex A of CDEPS-BPS-EXPORT provides some explanatory information about the used notation.

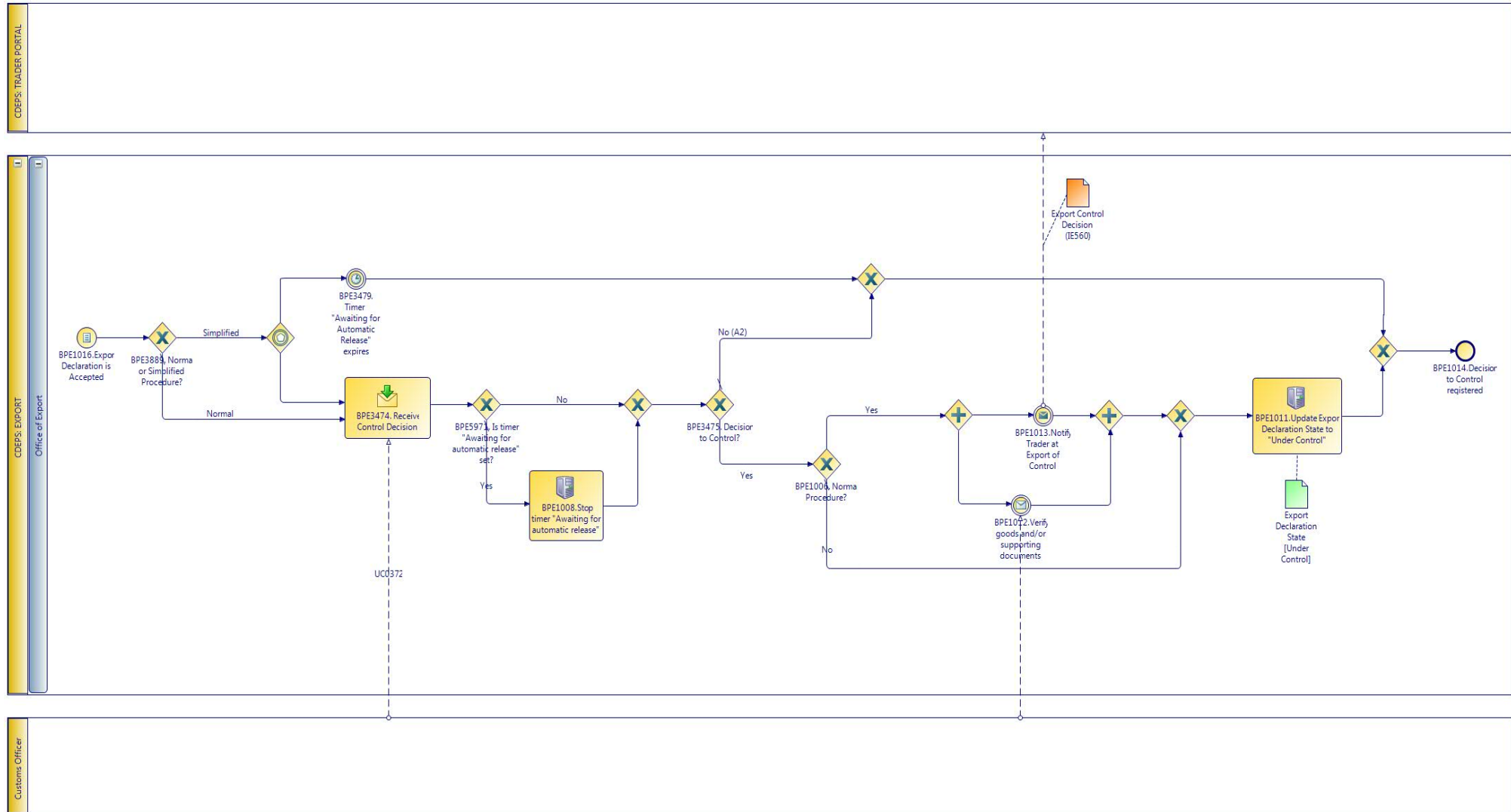

CARM Customs Declaration and Excise Documents Processing system (CDEPS)	REF: CDEPS_EXPORT_BPS
Business Process Specifications for EXPORT System	VER:410

2.1.7.1 Activities

The table below defines the 'Activities' of the 'BP0117. Decide to Control' process.

Element Name	Description	Special Type
BPE1008. Stop timer "Awaiting for automatic release"	Under normal procedure the Customs Officer decides to perform control. The timer awaiting for the automatic releases of the declaration stops.	Service Task
↳ Business Rule	132 Stop timer	
↳ Business Rule	186 Start / End day of Timers	
BPE1011. Update Export /Exit Summary Declaration State to "Under Control"	The system updates the Export /Exit Summary Declaration State to "Under Control" upon the customs officer's decision to control.	Service Task
BPE3474. Receive Control Decision	The system receives Customs Officer's control decision	Receive Task

2.1.7.2 Event(s)

The table below defines the 'Event(s)' of the 'BP0117. Decide to Control' process.

Element Name	Description	Special Type
BPE1012. Verify goods and/or supporting documents	The customs officer proceeds to the physical control of the goods and/or any supporting documents	Intermediate
BPE1013. Notify Trader at Export of Control	The system notifies the Trader of the decision to perform control at Export.	Intermediate
BPE1014. Decision to Control registered	The decision to control is finalized and the process terminates.	End
BPE1016. Export Declaration is Accepted	The export declaration has been accepted and the process begins.	Start

CARM Customs Declaration and Excise Documents Processing system (CDEPS)	REF: CDEPS_EXPORT_BPS
Business Process Specifications for EXPORT System	VER:410

BPE3479. BPE3479. Timer "Awaiting for Automatic Release" expires	No control decision is received from the Customs Officer and the timer set for the automatic release of the declaration expires.	Intermediate
---	--	--------------

↳ **Business Rule** 186 Start / End day of Timers

2.1.7.3 Gateway(s)

The table below defines the 'Gateway(s)' of the 'BP0117. Decide to Control' process.

Element Name	Description	Special Type
BPE1006. Normal Procedure?	A decision point in the process to split the flow based on whether it is a normal or simplified procedure.	Decision
↳ Business Rule 386	<i>Normal Procedure Declaration</i>	
BPE3475. Decision to Control?	A decision point in the process to navigate the flow based on the Customs Officer control decision	Decision
↳ Business Rule 28	<i>Decision to control</i>	
BPE3889. Normal or Simplified Procedure?	A decision point in the process to split the flow based on whether it is a normal or simplified procedure.	Decision
BPE5971. Is timer "Awaiting for automatic release" set?	A decision point in the process to navigate the flow based on whether the timer "Awaiting for automatic release" has been set for a simplified procedure.	Decision

CARM Customs Declaration and Excise Documents Processing system (CDEPS)	REF: CDEPS_EXPORT_BPS
Business Process Specifications for EXPORT System	VER:410

2.1.8.BP0118. Handle Results of a Control

Business Process Description

The following table provides general information about the 'BP0118. Handle Results of a Control' process. The Business Process Diagram and the description of various business process elements are specified in the following paragraphs.

Description	Reusable subprocess that describes the tasks performed by the system in order to handle the results of the Export control performed at an earlier stage.
Precondition(s)	Control results are received
Trigger	The process is triggered when the Control results are received
Postcondition(s)	<ul style="list-style-type: none"> - Idle - Under possible release - Not released for Export

Business Process Diagram

The Business Process Diagram of 'BP0118. Handle Results of a Control' is shown below in BPMN notation. The definition of a process that might be used as sub-process by the 'BP0118. Handle Results of a Control' can be found in this document. Finally, Annex A of CDEPS-BPS-EXPORT provides some explanatory information about the used notation.

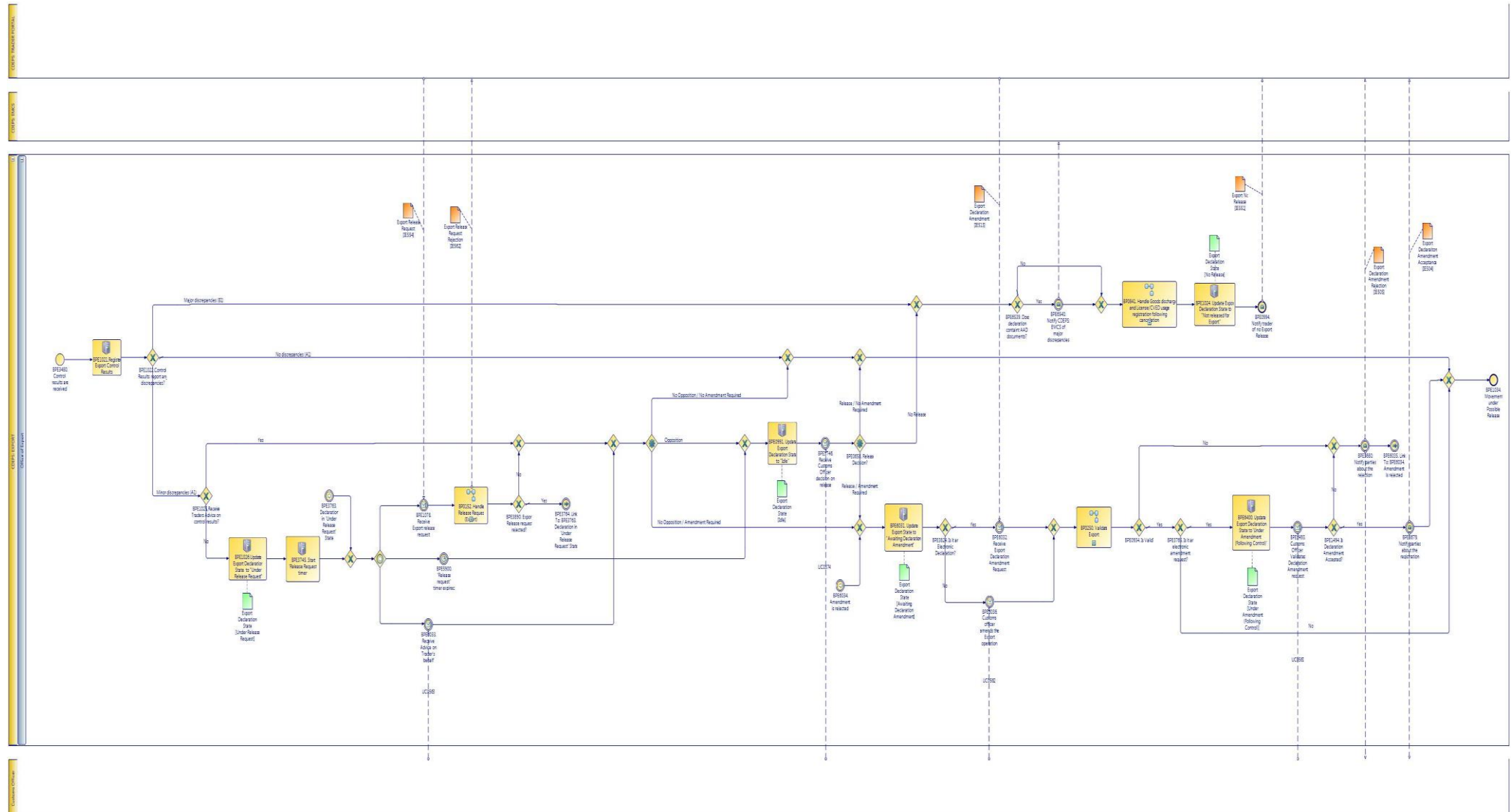

CARM Customs Declaration and Excise Documents Processing system (CDEPS)	REF: CDEPS_EXPORT_BPS
Business Process Specifications for EXPORT System	VER:410

2.1.8.1 Activities

The table below defines the 'Activities' of the 'BP0118. Handle Results of a Control' process.

Element Name	Description	Special Type
BPE0991. Update Export Declaration State to "Idle"	The system updates the state of the declaration to "Idle" upon the expiration of the "Declaration Awaiting Automatic Release" timer.	Service Task
BPE1021. Register Export Control Results	Under both Normal or Simplified procedure the valid export control results are registered into the system.	Service Task
BPE1024. Update Export Declaration State to "Not Released for Export"	The system updates the state of the declaration to "Not Released for Export" due to major discrepancies reported in control results or the expiration of the guarantee awaiting amendment timer	Service Task
BPE1026. Update Export Declaration State to "Under Release Request"	The system updates the state of the declaration to "Under Release Request"	Service Task
BPE3745. Start 'Release Request' timer	Start 'Release Request' timer	Service Task
↳ Business Rule 186	<i>Start / End day of Timers</i>	
BPE6031. Update Export State to "Awaiting Declaration Amendment"	The system updates the Export Declaration State to "Awaiting Declaration Amendment"	Service Task
BPE6400. Update Export Declaration State to 'Under Amendment (Following Control)'	Update Export Declaration State to 'Under Amendment (Following Control)'	Service Task

CARM Customs Declaration and Excise Documents Processing system (CDEPS)	REF: CDEPS_EXPORT_BPS
Business Process Specifications for EXPORT System	VER:410

2.1.8.2 Event(s)

The table below defines the 'Event(s)' of the 'BP0118. Handle Results of a Control' process.

Element Name	Description	Special Type
BPE0994. Notify trader of no Export Release	The decision not to release the movement for export is communicated to the Trader.	End
BPE1034. Movement under Possible Release	The Trader makes no opposition and the movement is possible to get releases. The process terminates	End
BPE1078. Receive Export release request	The system receives the Export release request from Trader Portal	Intermediate
BPE1493. Customs Officer Validates Declaration Amendment request	The Customs Officer validates the amendment request and the flow continues.	Intermediate
BPE3480. Control results are received	The Control results are received	Start
BPE3679. Notify parties about the registration	Upon the validation of the Declaration data the parties are notified of the successful registration	Intermediate
BPE3680. Notify parties about the rejection	Upon the invalidation of the Declaration data the parties are notified of the rejection	Intermediate
BPE3746. Receive Customs Officer decision on release	Receive Customs Officer decision on release	Intermediate
BPE3763. Declaration in 'Under Release Request' State	Declaration in 'Under Release Request' State	Intermediate

CARM Customs Declaration and Excise Documents Processing system (CDEPS)	REF: CDEPS_EXPORT_BPS	
Business Process Specifications for EXPORT System	VER:410	
BPE3764. Link To:	Link To: BPE3763. Declaration in 'Under Release Request' State	Intermediate
BPE3763. Declaration in 'Under Release Request' State		
BPE3766. Notify Customs Officer of Amendment request rejection	Notify Customs Officer of Amendment request rejection	Intermediate
BPE5900. "Release request" timer expired	The "Release request" timer expired	Intermediate
BPE6032. Receive Export Declaration Amendment Request	Receive Export Declaration Amendment Request	Intermediate
BPE6033. Receive Advice on Trader's behalf	The system receives the Trader's advice on control findings on his/her behalf	Intermediate
BPE6034. Amendment is rejected	Amendment is rejected	Intermediate
BPE6035. Link To:	Link To: BPE6034. Amendment is rejected	Intermediate
BPE6034. Amendment is rejected		
BPE6036. Customs officer amends the Export operation	Customs officer amends the Export operation	Intermediate
BPE6540. Notify CDEPS: EMCS of major discrepancies	The system notifies CDEPS: EMCS of major discrepancies (result code - B1)	Intermediate

CARM Customs Declaration and Excise Documents Processing system (CDEPS)	REF: CDEPS_EXPORT_BPS
Business Process Specifications for EXPORT System	VER:410

2.1.8.3 Gateway(s)

The table below defines the 'Gateway(s)' of the 'BP0118. Handle Results of a Control' process.

Element Name	Description	Special Type
BPE0658. Release Decision?	Release decision?	Decision
BPE0934. Is Valid?	A decision point in the process to navigate the flow based on the message validation result.	Decision
↳ Business Rule 638	<i>Import declaration type 'X' cannot be cancelled</i>	
↳ Business Rule 646	<i>Guarantees during the registration of Import declaration type 'X'</i>	
↳ Business Rule 80	<i>Valid Message</i>	
BPE1022. Control Results report any discrepancies?	A decision point on the process to split the flow based on the control results reported no, major or minor discrepancies.	Decision
↳ Business Rule 29	<i>Check if control results are satisfactory</i>	
BPE1025. Receive Traders Advice on control results?	A decision point in the process to split the flow according to whether the Trader has given his advice or not.	Decision
BPE1494. Is Declaration Amendment Accepted?	A decision point in the process to split the flow based on the validation results of the amendment request performed by the Customs Officer	Decision
BPE3765. Is it an electronic amendment request?	A decision point in the flow to navigate the process based on whether the amendment request is electronic or not	Decision
BPE3824. Is it an Electronic Declaration?	A decision point in the process to navigate the flow based on whether the declaration is electronic or not	Decision
BPE3890. Export Release request rejected?	A decision point in the process to navigate the flow based on whether the Export Release request has been rejected or not.	Decision

CARM Customs Declaration and Excise Documents Processing system (CDEPS)	REF: CDEPS_EXPORT_BPS
Business Process Specifications for EXPORT System	VER:410

BPE6539. Does declaration contain AAD documents? A decision point in the process to navigate the flow based on whether major discrepancies were reported on a declaration containing AAD documents. Decision

↳ **Business Rule** 497 *Discrepancies on e-AD documents*

CARM Customs Declaration and Excise Documents Processing system (CDEPS)	REF: CDEPS_EXPORT_BPS
Business Process Specifications for EXPORT System	VER:410

2.1.9.BP0152. Handle Release Request (Export)

Business Process Description

The following table provides general information about the 'BP0152. Handle Release Request (Export)' process. The Business Process Diagram and the description of various business process elements are specified in the following paragraphs.

Description	A high level process describing the actions performed by the system in order to handle the export release request
Precondition(s)	Export Release Request is received
Trigger	The process is triggered when the Export Release Request is received
Postcondition(s)	- None - Under Release request

Business Process Diagram

The Business Process Diagram of 'BP0152. Handle Release Request (Export)' is shown below in BPMN notation. The definition of a process that might be used as sub-process by the 'BP0152. Handle Release Request (Export)' can be found in this document. Finally, Annex A of CDEPS-BPS-EXPORT provides some explanatory information about the used notation.

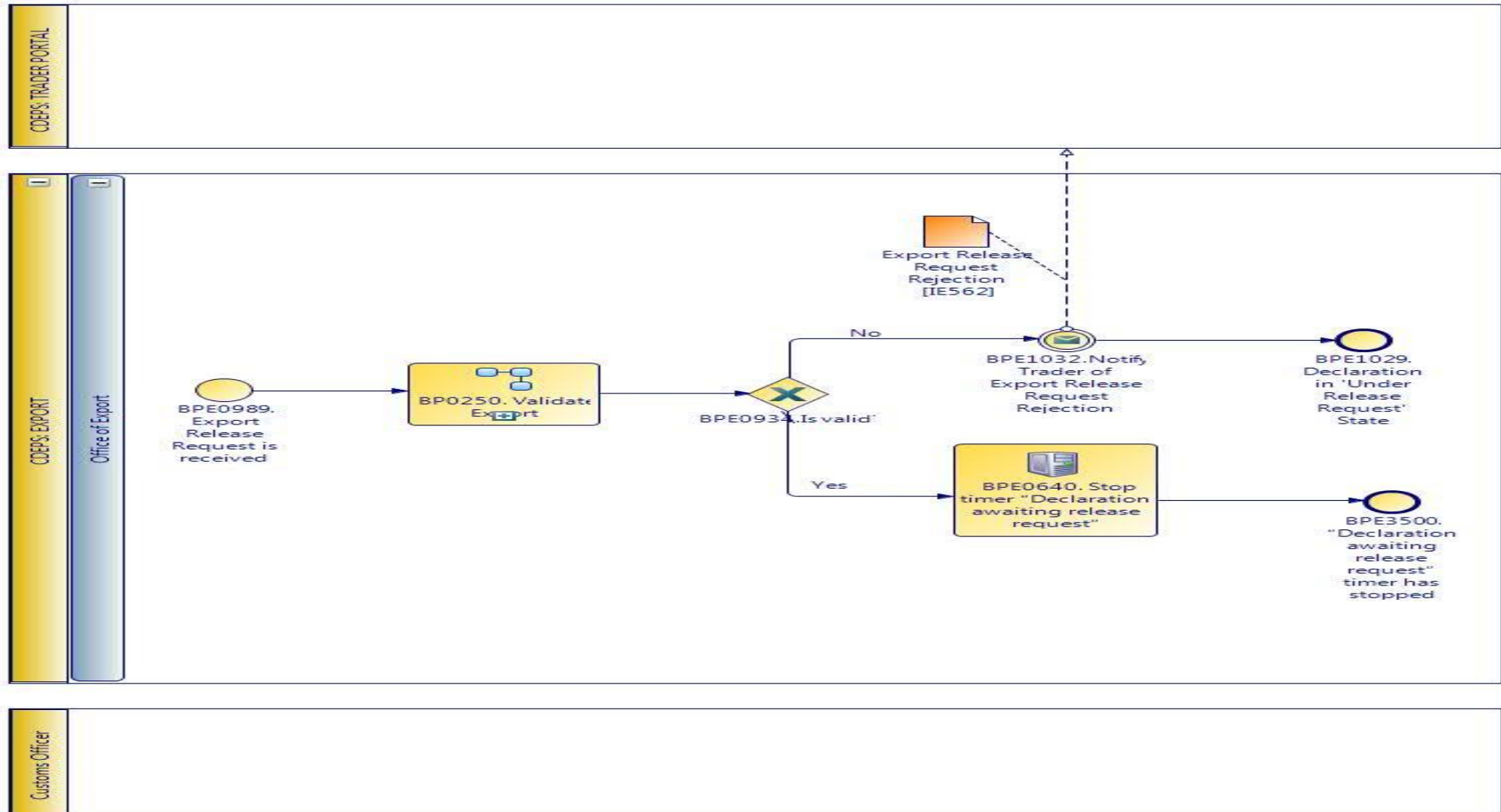

CARM Customs Declaration and Excise Documents Processing system (CDEPS)	REF: CDEPS_EXPORT_BPS
Business Process Specifications for EXPORT System	VER:410

2.1.9.1 Activities

The table below defines the 'Activities' of the 'BP0152. Handle Release Request (Export)' process.

Element Name	Description	Special Type
BPE5908. Stop timer "Release Request"	The timer "Release Request" stops once the Export Release request is received from Trader.	Service Task

2.1.9.2 Event(s)

The table below defines the 'Event(s)' of the 'BP0152. Handle Release Request (Export)' process.

Element Name	Description	Special Type
BPE0989. Export Release Request is received	The Office of Export receives the request from Trader to release the goods for Export.	Start
BPE1029. Declaration in 'Under Release Request' State	The declaration is 'Under Release Request' State and the process terminates.	End
BPE1032. Notify Trader of Export Release Request Rejection	Declaration Response does not include the requested data and implied diversion is rejected (IE521)	End
BPE3500. "Declaration awaiting release request" timer has	The "Declaration awaiting release request" timer has stopped	End

↳ **Business Rule** 186 Start / End day of Timers

2.1.9.3 Gateway(s)

The table below defines the 'Gateway(s)' of the 'BP0152. Handle Release Request (Export)' process.

Element Name	Description	Special Type
BPE0934. Is Valid?	A decision point in the process to navigate the flow based on the message validation result.	Decision

↳ **Business Rule** 638 Import declaration type 'X' cannot be cancelled

CARM Customs Declaration and Excise Documents Processing system (CDEPS)	REF: CDEPS_EXPORT_BPS
Business Process Specifications for EXPORT System	VER:410
↳ Business Rule 646	<i>Guarantees during the registration of Import declaration type 'X'</i>
↳ Business Rule 80	<i>Valid Message</i>

CARM Customs Declaration and Excise Documents Processing system (CDEPS)	REF: CDEPS_EXPORT_BPS
Business Process Specifications for EXPORT System	VER:410

2.1.10.BP0520. Register Guarantee Usage at Export

Business Process Description

The following table provides general information about the 'BP0520. Register Guarantee Usage at Export' process. The Business Process Diagram and the description of various business process elements are specified in the following paragraphs.

Description	A sub-process that describes the actions performed by the system in order to register the usage of the Guarantees
Precondition(s)	<ul style="list-style-type: none"> - Declaration covered by guarantee(s) - Guarantee Amendment Accepted
Trigger	The process is triggered when the Declaration is covered by guarantee(s) or a guarantee amendment has been accepted
Postcondition(s)	<ul style="list-style-type: none"> - None - Guarantee Usage Registered - Guarantee Use Rejected - Not released for Export

Business Process Diagram

The Business Process Diagram of 'BP0520. Register Guarantee Usage at Export' is shown below in BPMN notation. The definition of a process that might be used as sub-process by the 'BP0520. Register Guarantee Usage at Export' can be found in this document. Finally, Annex A of CDEPS-BPS-EXPORT provides some explanatory information about the used notation.

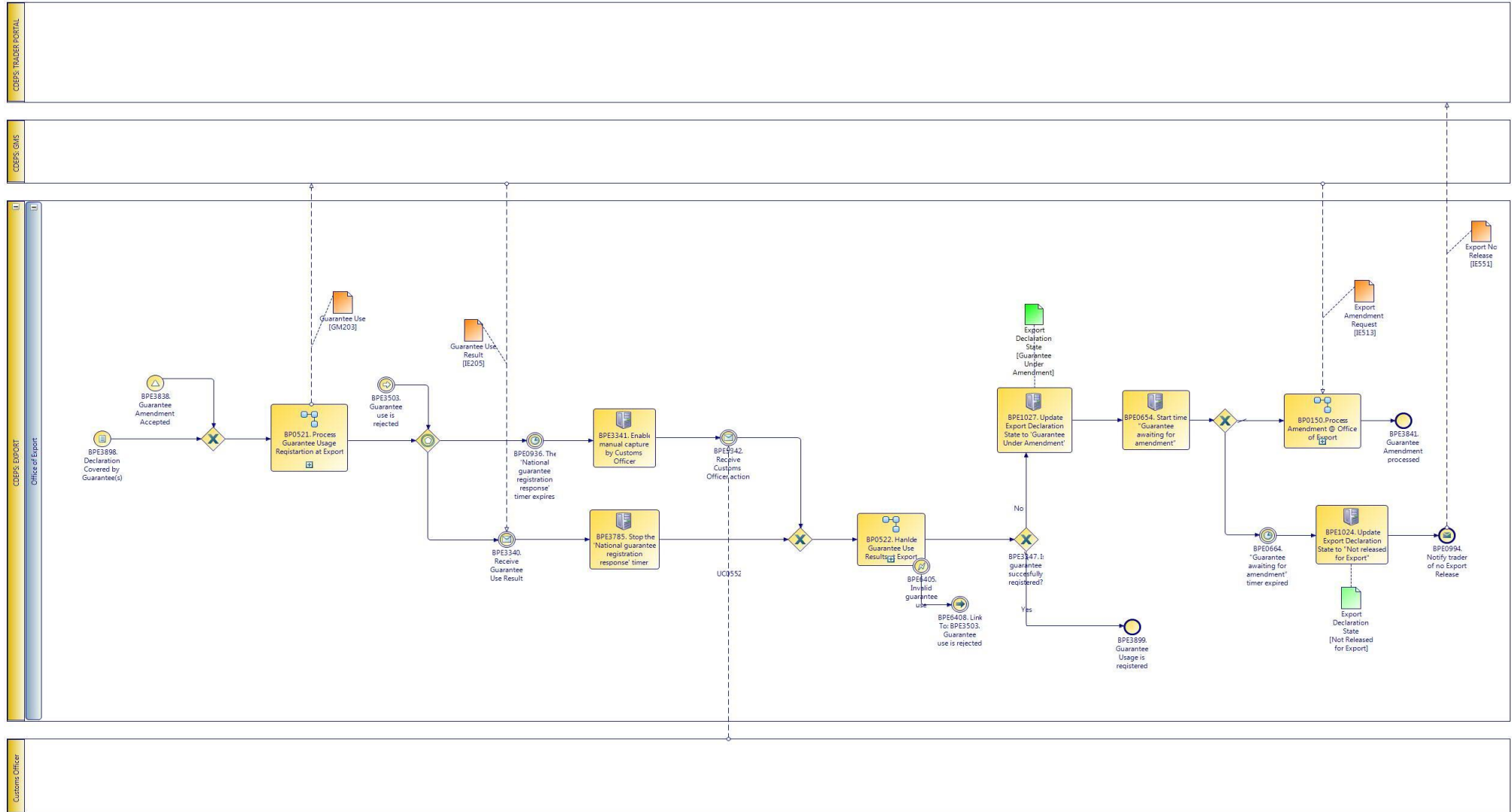

CARM Customs Declaration and Excise Documents Processing system (CDEPS)	REF: CDEPS_EXPORT_BPS
Business Process Specifications for EXPORT System	VER:410

2.1.10.1 Activities

The table below defines the 'Activities' of the 'BP0520. Register Guarantee Usage at Export' process.

Element Name	Description	Special Type
BPE0654. Start timer "Guarantee awaiting for amendment"	Start timer "Guarantee awaiting for amendment"	Service Task
BPE1024. Update Export Declaration State to "Not Released for Export"	The system updates the state of the declaration to "Not Released for Export" due to major discrepancies reported in control results or the expiration of the guarantee awaiting amendment timer	Service Task
BPE1027. Update Export Declaration State to 'Guarantee Under Amendment'	Update Export Declaration State to 'Guarantee Under Amendment'	Service Task
BPE3341. Enable manual capture by Customs Officer	The Customs Officer is enabled to register manually the Guarantee Usage	Service Task
BPE3342. Receive Customs Officer action	The Customs Officer's action is received	Service Task
BPE3785. Stop the 'National guarantee registration response' timer	The system stops the 'National guarantee registration response' timer upon the receipt of the Guarantee Use Result.	Service Task

↳ **Business Rule** 132 Stop timer

CARM Customs Declaration and Excise Documents Processing system (CDEPS)	REF: CDEPS_EXPORT_BPS
Business Process Specifications for EXPORT System	VER:410

2.1.10.2 Event(s)

The table below defines the 'Event(s)' of the 'BP0520. Register Guarantee Usage at Export' process.

Element Name	Description	Special Type
BPE0664. "Guarantee awaiting for amendment" timer expired	"Guarantee awaiting for amendment" timer expired	Start
BPE0936. The 'National guarantee registration response' timer expires	The 'National guarantee registration response' timer expires	Intermediate
BPE0994. Notify trader of no Export Release	The decision not to release the movement for export is communicated to the Trader.	End
BPE3340. Receive Guarantee Use Result	The system receives the guarantee use results from CDEPS: GMS	Intermediate
BPE3503. Guarantee use is rejected	The Guarantee use is rejected	Intermediate
BPE3838. Guarantee Amendment Accepted	A start event in the process catching the signal thrown by the processing of the amendment when the Guarantee amendment is accepted.	Start
BPE3841. Guarantee Amendment processed	The Guarantee Amendment is processed	End
BPE3898. Declaration Covered by Guarantee(s)	Declaration Covered by Guarantee(s)	Start
BPE3899. Guarantee Usage is registered	The usage of the guarantee is registered	End
BPE6405. Invalid guarantee use	Invalid guarantee use	Intermediate

CARM Customs Declaration and Excise Documents Processing system (CDEPS)	REF: CDEPS_EXPORT_BPS
Business Process Specifications for EXPORT System	VER:410

BPE6408. Link To: An intermediate event linked to BPE3503. Guarantee use is rejected Intermediate

BPE3503. Guarantee use is rejected

2.1.10.3 Gateway(s)

The table below defines the 'Gateway(s)' of the 'BP0520. Register Guarantee Usage at Export' process.

Element Name	Description	Special Type
BPE3347. Is guarantee successfully registered?	A decision point in the process to navigate the flow based on whether the guarantee usage is successfully registered	Decision

CARM Customs Declaration and Excise Documents Processing system (CDEPS)	REF: CDEPS_EXPORT_BPS
Business Process Specifications for EXPORT System	VER:410

2.1.11.BP0521. Process Guarantee Usage Registration at Export

Business Process Description

The following table provides general information about the 'BP0521. Process Guarantee Usage Registration at Export' process. The Business Process Diagram and the description of various business process elements are specified in the following paragraphs.

Description	A sub-process that describes the actions performed by the system in order to process the usage of the Guarantees
--------------------	--

Precondition(s)	<ul style="list-style-type: none"> - The Movement is covered by Guarantee(s) - Guarantee under registration upon successful guarantee data amendment
------------------------	--

Trigger	The process is triggered when the Declaration is covered by guarantee(s) or a guarantee is under registration upon successful guarantee data amendment
----------------	--

Postcondition(s)	Guarantee Under Registration
-------------------------	------------------------------

Business Process Diagram

The Business Process Diagram of 'BP0521. Process Guarantee Usage Registration at Export' is shown below in BPMN notation. The definition of a process that might be used as sub-process by the 'BP0521. Process Guarantee Usage Registration at Export' can be found in this document. Finally, Annex A of CDEPS-BPS-EXPORT provides some explanatory information about the used notation.

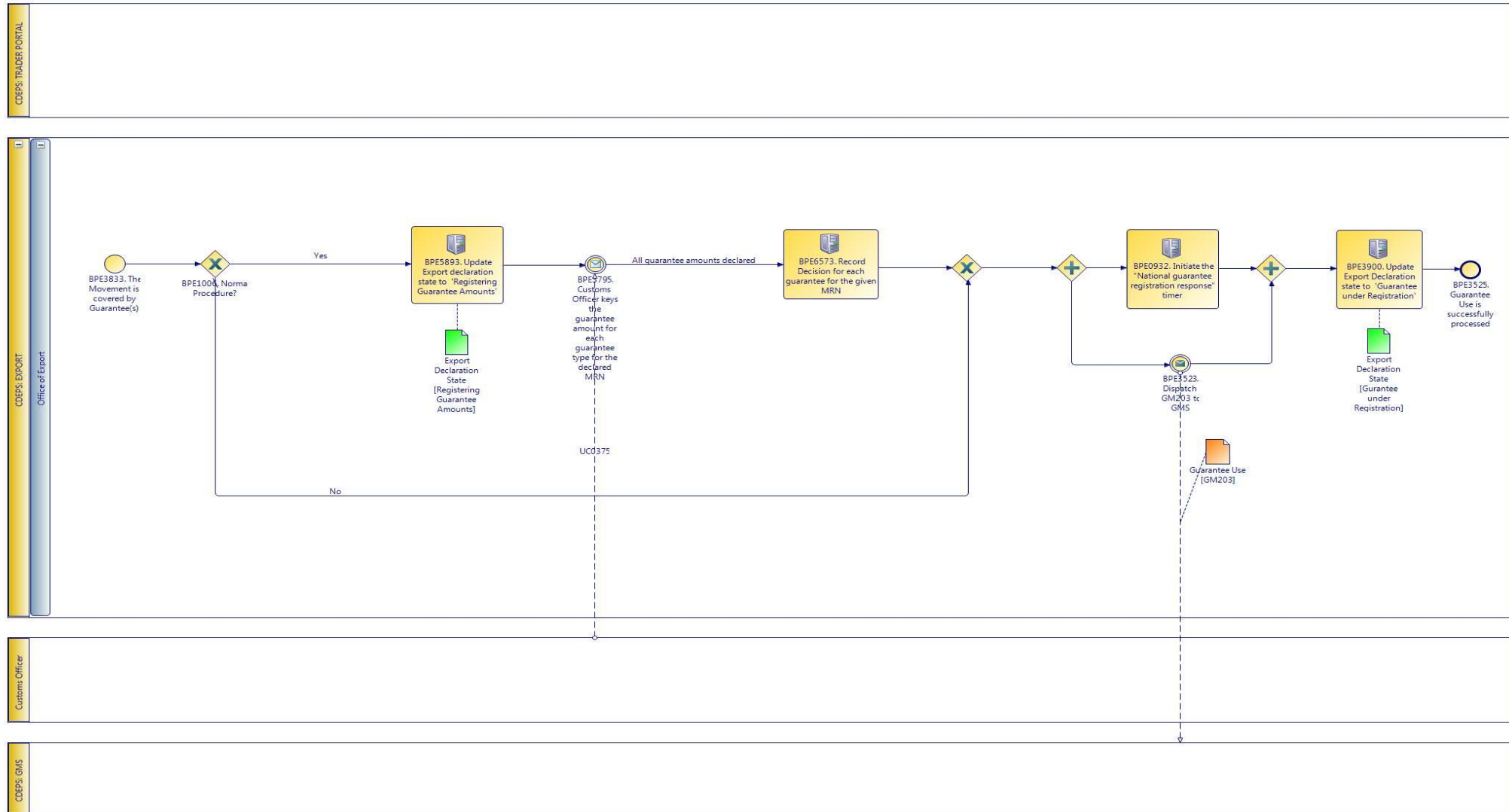

CARM Customs Declaration and Excise Documents Processing system (CDEPS)	REF: CDEPS_EXPORT_BPS
Business Process Specifications for EXPORT System	VER:410

2.1.11.1 Activities

The table below defines the 'Activities' of the 'BP0521. Process Guarantee Usage Registration at Export' process.

Element Name	Description	Special Type
BPE0932. Initiate the "National guarantee registration response" timer	The "National guarantee registration response" timer starts	Service Task
BPE3900. Update Export Declaration state to 'Guarantee under Registration'	The system updates the state of the Export Declaration to 'Guarantee under Registration'	Service Task
BPE5893. Update Export declaration state to 'Registering Guarantee Amounts'	Update Export declaration state to 'Registering Guarantee Amounts'	Service Task
BPE6573. Record Decision for each guarantee for the given MRN	Record Decision for each guarantee for the given MRN	Service Task

2.1.11.2 Event(s)

The table below defines the 'Event(s)' of the 'BP0521. Process Guarantee Usage Registration at Export' process.

Element Name	Description	Special Type
BPE3523. Dispatch GM203 to GMS	The system dispatches the GM203 to CDEPS: GMS	Intermediate
BPE3525. Guarantee Use is successfully processed	Guarantee Use is successfully processed	End

CARM Customs Declaration and Excise Documents Processing system (CDEPS)	REF: CDEPS_EXPORT_BPS
Business Process Specifications for EXPORT System	VER:410

BPE3795. Customs Officer keys the guarantee amount for each guarantee type for the declared MRN	Customs Officer keys the guarantee amount for each guarantee type for the declared MRN	Intermediate
--	--	--------------

↳ **Business Rule** 390 *Registering Guarantee Amounts*

BPE3833. The Movement is covered by Guarantee(s)	The Movement is covered by Guarantee(s)	Start
---	---	-------

2.1.11.3 Gateway(s)

The table below defines the 'Gateway(s)' of the 'BP0521. Process Guarantee Usage Registration at Export' process.

Element Name	Description	Special Type
BPE1006. Normal Procedure?	A decision point in the process to split the flow based on whether it is a normal or simplified procedure.	Decision
↳ Business Rule 386	<i>Normal Procedure Declaration</i>	

CARM Customs Declaration and Excise Documents Processing system (CDEPS)	REF: CDEPS_EXPORT_BPS
Business Process Specifications for EXPORT System	VER:410

2.1.12.BP0522. Hanlde Guarantee Use Results

Business Process Description

The following table provides general information about the 'BP0522. Hanlde Guarantee Use Results' process. The Business Process Diagram and the description of various business process elements are specified in the following pragraphs.

Description	Reusable subprocess that describes the tasks performed by the system in order to handle the guarantee use results received from CDEPS: GMS
Precondition(s)	<ul style="list-style-type: none"> - IE205 message received - Manual guarantee registration
Trigger	The process starts when the IE205 message is received or the Customs Officer has decided to register manually the guarantee
Postcondition(s)	<ul style="list-style-type: none"> - None - Not released for Export - Guarantee Registered

Business Process Diagram

The Business Process Diagram of 'BP0522. Handle Guarantee Use Results' is shown below in BPMN notation. The definition of a process that might be used as sub-process by the 'BP0522. Handle Guarantee Use Results' can be found in this document. Finally, Annex A of CDEPS-BPS-EXPORT provides some explanatory information about the used notation.

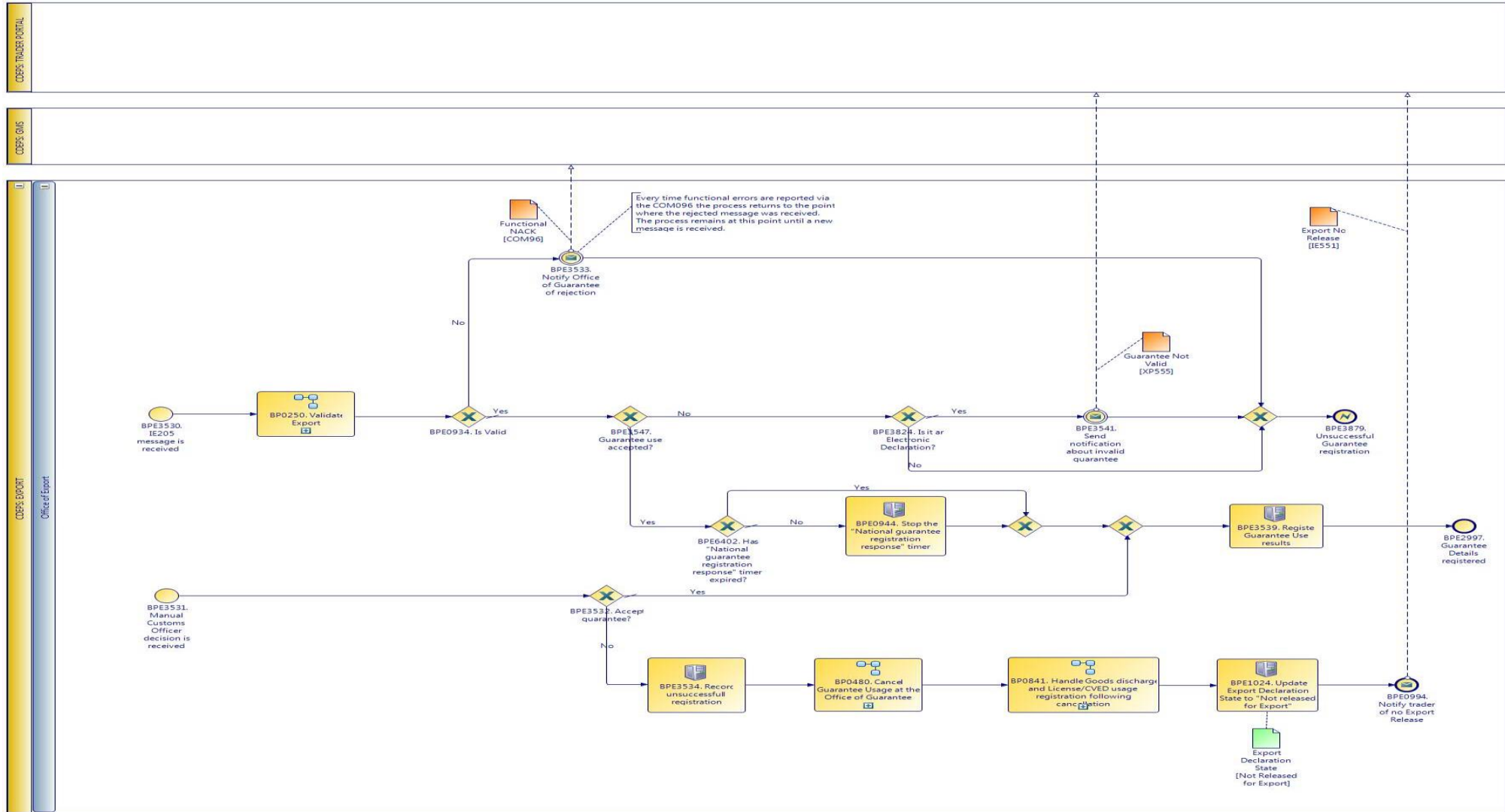

CARM Customs Declaration and Excise Documents Processing system (CDEPS)	REF: CDEPS_EXPORT_BPS
Business Process Specifications for EXPORT System	VER:410

2.1.12.1 Activities

The table below defines the 'Activities' of the 'BP0522. Handle Guarantee Use Results' process.

Element Name	Description	Special Type
BPE0944. Stop the "National guarantee registration response" timer	The "National guarantee registration response" timer stops	Service Task
BPE1024. Update Export Declaration State to "Not Released for Export"	The system updates the state of the declaration to "Not Released for Export" due to major discrepancies reported in control results or the expiration of the guarantee awaiting amendment timer	Service Task
BPE3534. Record unsuccessful registration	The system records the Customs Officer's decision not to register the guarantee use.	Service Task
BPE3539. Register Guarantee Use results	The system registers the Guarantee Use results upon its validation	Service Task

2.1.12.2 Event(s)

The table below defines the 'Event(s)' of the 'BP0522. Handle Guarantee Use Results' process.

Element Name	Description	Special Type
BPE0994. Notify trader of no Export Release	The decision not to release the movement for export is communicated to the Trader.	End
BPE2997. Guarantee Details registered	Guarantee Details registered	End
BPE3530. IE205 message is received	The guarantee use result (IE205 message) are received	Start
BPE3531. Manual Customs Officer decision is received	The Customs Officer decision is received	Start

CARM Customs Declaration and Excise Documents Processing system (CDEPS)	REF: CDEPS_EXPORT_BPS
Business Process Specifications for EXPORT System	VER:410

BPE3533. Notify Office of Guarantee of rejection	The Office of Guarantee is notified of the guarantee use result rejection	Intermediate
BPE3541. Send notification about invalid guarantee	A notification about invalid guarantee is sent to the Trader	Intermediate
BPE3879. Unsuccessful Guarantee registration	The guarantee details are not registered and the process terminates	End

2.1.12.3 Gateway(s)

The table below defines the 'Gateway(s)' of the 'BP0522. Handle Guarantee Use Results' process.

Element Name	Description	Special Type
BPE0934. Is Valid?	A decision point in the process to navigate the flow based on the message validation result.	Decision
↳ Business Rule 638	<i>Import declaration type 'X' cannot be cancelled</i>	
↳ Business Rule 646	<i>Guarantees during the registration of Import declaration type 'X'</i>	
↳ Business Rule 80	<i>Valid Message</i>	
BPE3532. Accept guarantee?	A decision point in the process to navigate the flow based on whether the Customs Officer's decision to accept the guarantee or not.	Decision
BPE3547. Guarantee use accepted?	A decision point in the process to navigate the flow based on whether the Guarantee Use is accepted	Decision
BPE3824. Is it an Electronic Declaration?	A decision point in the process to navigate the flow based on whether the declaration is electronic or not	Decision
BPE6402. Has "National guarantee registration response" timer expired?	A decision point in the process to navigate the flow based on whether the "National guarantee registration response" timer has expired or not.	Decision

CARM Customs Declaration and Excise Documents Processing system (CDEPS)	REF: CDEPS_EXPORT_BPS
Business Process Specifications for EXPORT System	VER:410

2.1.13.BP0002. Perform risk analysis

Business Process Description

The following table provides general information about the 'BP0002. Perform risk analysis' process. The Business Process Diagram and the description of various business process elements are specified in the following paragraphs.

Description	Reusable subprocess performing the risk analysis task, requesting and handling the response from an external system
Precondition(s)	The declaration is being accepted
Trigger	Risk Analysis request
Postcondition(s)	Risk analysis registered

Business Process Diagram

The Business Process Diagram of 'BP0002. Perform risk analysis' is shown below in BPMN notation. The definition of a process that might be used as sub-process by the 'BP0002. Perform risk analysis' can be found in this document. Finally, Annex A of CDEPS-BPS-EXPORT provides some explanatory information about the used notation.

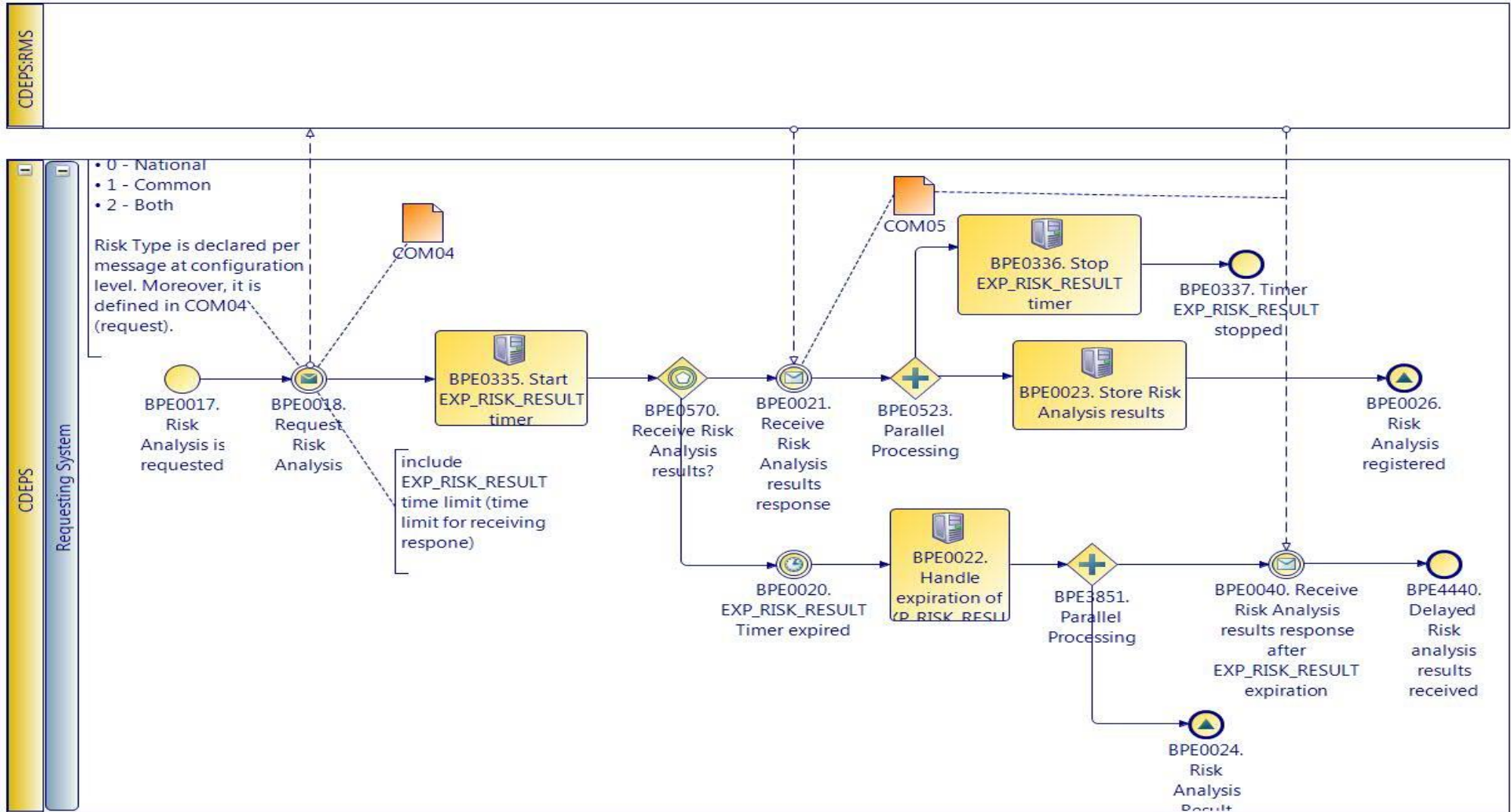

CARM Customs Declaration and Excise Documents Processing system (CDEPS)	REF: CDEPS_EXPORT_BPS
Business Process Specifications for EXPORT System	VER:410

2.1.13.1 Activities

The table below defines the 'Activities' of the 'BP0002. Perform risk analysis' process.

Element Name	Description	Special Type
BPE0018. Request Risk Analysis	When a risk analysis has to be performed, the system prepare and submit a risk analysis request (COM04) to the RMS. This request includes among other information, the risk analysis type and the message for which is risk analysis is requested.	Send Task
BPE0022. Handle expiration of EXP_RISK_RESULT timer.	The system performs the following actions: - registers Risk Analysis result "Z" in order to resume the process. - generates and assigns a random national risk score by employing the national risk algorithm - risk registers delayed Risk Analysis Results.	Service Task
↳ Business Rule 517	<i>Generation of random national risk score</i>	
BPE0023. Store Risk Analysis results	The system registers the received risk analysis results successfully.	Service Task
BPE0335. Start EXP_RISK_RESULT timer	Starts the EXP_RISK_RESULT timer.	User Task
BPE0336. Stop EXP_RISK_RESULT timer	Stop the EXP_RISK_RESULT timer when the Risk Analysis Results (COM05) are received from the RMS.	User Task

2.1.13.2 Event(s)

The table below defines the 'Event(s)' of the 'BP0002. Perform risk analysis' process.

Element Name	Description	Special Type
BPE0017. Risk Analysis is requested	A request is received for performing a risk analysis.	Start
BPE0020. EXP_RISK_RESULT Timer expired	No response is received on time (EXP_RISK_RESULT Timer for risk analysis results response expired)	Intermediate

CARM Customs Declaration and Excise Documents Processing system (CDEPS)	REF: CDEPS_EXPORT_BPS
Business Process Specifications for EXPORT System	VER:410
BPE0021. Receive Risk Analysis results response	Receive the risk analysis results (COM05) on time Intermediate
BPE0024. Risk Analysis Result Code "Z" registered	A signal "Risk Analysis Result Code "Z" registered" is disseminated for resuming the process requested the risk analysis while at the same time the system expects the risk analysis results at some point of time. End
BPE0026. Risk Analysis registered	The process ends with the successful registration of risk analysis results End
BPE0040. Receive Risk Analysis results response after EXP_RISK_RESULT expiration	At some point of time, the system receives the risk analysis results after the expiration of EXP_RISK_RESULT Timer for risk analysis results response. Intermediate
BPE0337. Timer EXP_RISK_RESULT stopped	This is the ending event in regards to the Timer (T1) stop. End
BPE4440. Delayed Risk analysis results received	Delayed Risk analysis results received End

2.1.13.3 Gateway(s)

The table below defines the 'Gateway(s)' of the 'BP0002. Perform risk analysis' process.

Element Name	Description	Special Type
BPE0523. Parallel Processing	Stop timer and store risk analysis results	Fork
BPE0570. Receive Risk Analysis results?	Receive Risk Analysis results response or timer waiting results expired?	Decision
BPE3851. Parallel Processing	Divide the path in two or more parallel paths (concurrent execution of tasks).	Fork

CARM Customs Declaration and Excise Documents Processing system (CDEPS)	REF: CDEPS_EXPORT_BPS
Business Process Specifications for EXPORT System	VER:410

2.1.14.BP0822. SLAR registration outside CLIS

Business Process Description

The following table provides general information about the 'BP0822. SLAR registration outside CLIS' process. The Business Process Diagram and the description of various business process elements are specified in the following paragraphs.

Description	Includes validation, acceptance/rejection and notification of relevant parties.
Precondition(s)	None.
Trigger	Manual submission of SLAR details by Customs Officer.
Postcondition(s)	SLAR send to CLIS.

Business Process Diagram

The Business Process Diagram of 'BP0822. SLAR registration outside CLIS' is shown below in BPMN notation. The definition of a process that might be used as sub-process by the 'BP0822. SLAR registration outside CLIS' can be found in this document. Finally, Annex A of CDEPS-BPS-EXPORT provides some explanatory information about the used notation.

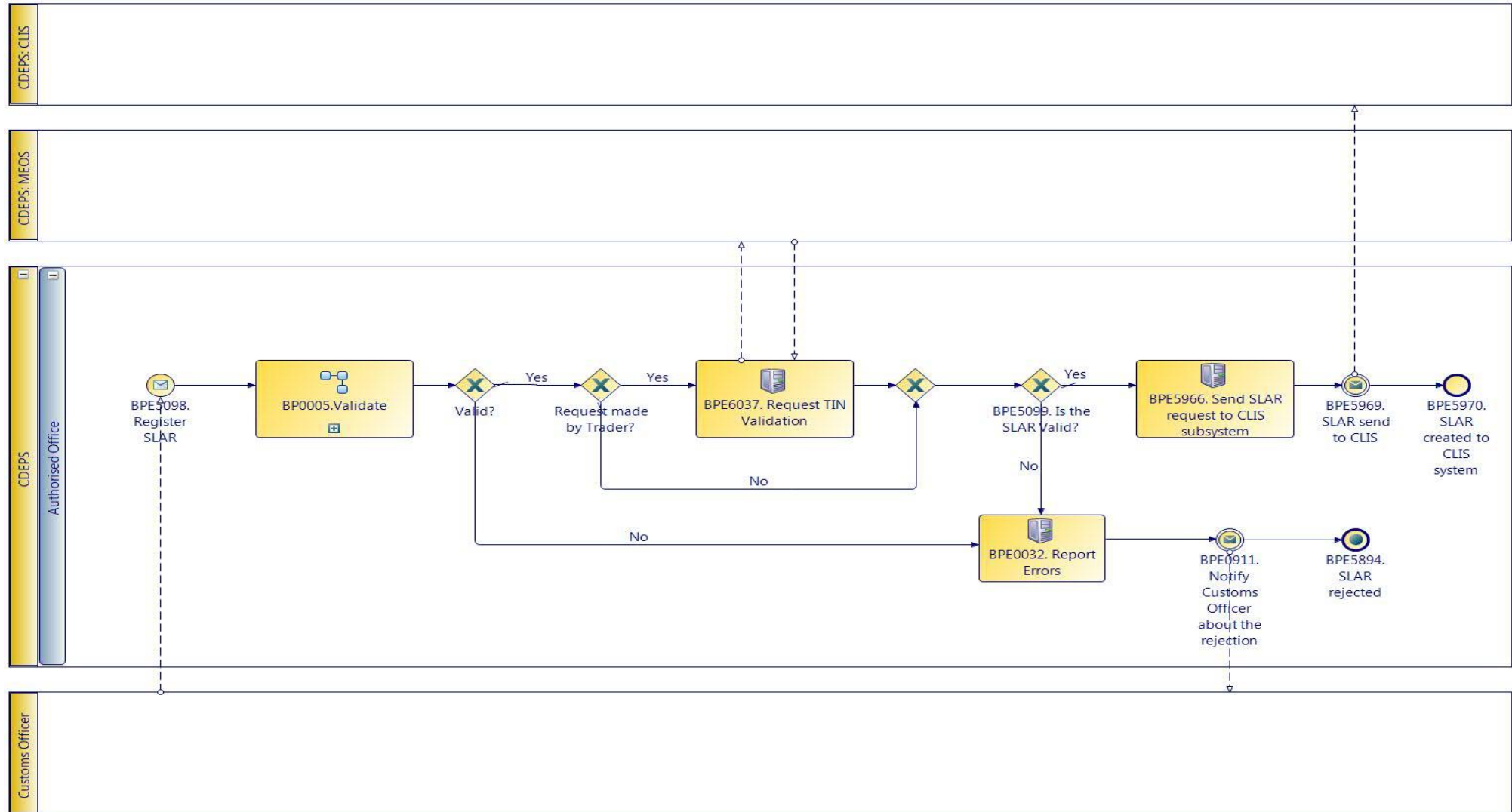

CARM Customs Declaration and Excise Documents Processing system (CDEPS)	REF: CDEPS_EXPORT_BPS
Business Process Specifications for EXPORT System	VER:410

2.1.14.1 Activities

The table below defines the 'Activities' of the 'BP0822. SLAR registration outside CLIS' process.

Element Name	Description	Special Type
BPE0032. Report Errors	Report the identified errors from the validation process. The process terminates.	Service Task
BPE5098. Register SLAR	The SLAR is registered.	Service Task
BPE5966. Send SLAR request to CLIS subsystem	The SLAR request shall be sent to CLIS subsystem.	Service Task
BPE6037. Request TIN Validation	Request TIN Validation from MEOS	Service Task

2.1.14.2 Event(s)

The table below defines the 'Event(s)' of the 'BP0822. SLAR registration outside CLIS' process.

Element Name	Description	Special Type
BPE0911. Notify customs officer about rejection	The Customs Officer is notified about the rejection of the request due to its invalidation.	End
BPE5894. SLAR rejected	The SLAR has been rejected.	End
BPE5969. SLAR send to CLIS	SLAR request send to CLIS	
BPE5970. SLAR created to CLIS system	SLAR has been created to CLIS system.	End

2.1.14.3 Gateway(s)

The table below defines the 'Gateway(s)' of the 'BP0822. SLAR registration outside CLIS' process.

Element Name	Description	Special Type
BPE5099. Is the SLAR Valid?	Is the SLAR Valid?	Decision

CARM Customs Declaration and Excise Documents Processing system (CDEPS)	REF: CDEPS_EXPORT_BPS
Business Process Specifications for EXPORT System	VER:410

2.1.15.BP0005. Validate

Business Process Description

The following table provides general information about the 'BP0005. Validate' process. The Business Process Diagram and the description of various business process elements are specified in the following paragraphs.

Description	Reusable subprocess that performs the message validation tasks
Precondition(s)	None
Trigger	The process is triggered when an electronic message is received for validation.
Postcondition(s)	

Business Process Diagram

The Business Process Diagram of 'BP0005. Validate' is shown below in BPMN notation. The definition of a process that might be used as sub-process by the 'BP0005. Validate' can be found in this document. Finally, Annex A of CDEPS-BPS-EXPORT provides some explanatory information about the used notation.

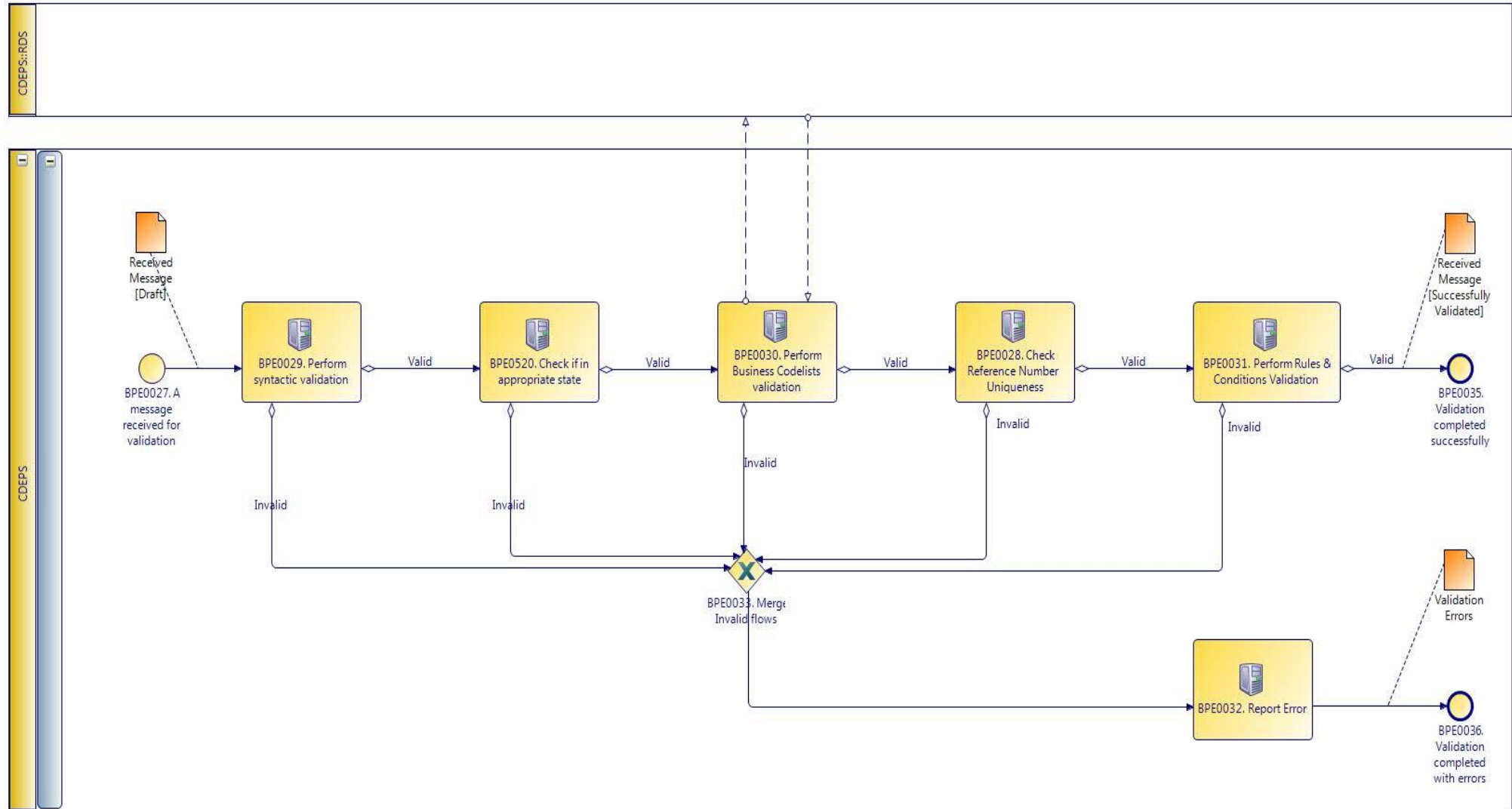

CARM Customs Declaration and Excise Documents Processing system (CDEPS)	REF: CDEPS_EXPORT_BPS
Business Process Specifications for EXPORT System	VER:410

2.1.15.1 Activities

The table below defines the 'Activities' of the 'BP0005. Validate' process.

Element Name	Description	Special Type
BPE0028. Check Reference Number Uniqueness	Check whether message reference numbers are unique in the system.	Service Task
↳ Business Rule 1	<i>Check Message Identification uniqueness</i>	
↳ Business Rule 74	<i>Check Local Reference Number (LRN) uniqueness</i>	
↳ Business Rule 75	<i>Check Movement Reference Number (MRN)uniqueness</i>	
↳ Business Rule 79	<i>Check Manifest reference number uniqueness</i>	
BPE0029. Perform syntactic validation	Check messages against the XSDs.	Service Task
↳ Business Rule 47	<i>Syntactic validation</i>	
BPE0030. Perform Business Codelists validation	Check the message business codelists.	Service Task
↳ Business Rule 50	<i>Business codelist validation against CDEPS:RDS</i>	
BPE0031. Perform Rules & Conditions Validation	Check the rules and conditions of the respective message.	Service Task
BPE0032. Report Errors	Report the identified errors from the validation process. The process terminates.	Service Task
BPE0520. Check if in appropriate state	Check whether the process for the particular entity (e.g. declaration/ application/ document) is on the appropriate state to process the received message. This check shall be performed based on the pertinent State Model of the system.	Service Task
↳ Business Rule 421	<i>Supplementary Declaration validation at Export</i>	
↳ Business Rule 448	<i>Check appropriate state for Export Declaration Amendment</i>	

CARM Customs Declaration and Excise Documents Processing system (CDEPS)	REF: CDEPS_EXPORT_BPS
Business Process Specifications for EXPORT System	VER:410

- ↳ **Business Rule** 449 *Check appropriate state Declaration Goods Presentation*
- ↳ **Business Rule** 468 *Guarantee Amendment*
- ↳ **Business Rule** 492 *Exit control results received at Export*
- ↳ **Business Rule** 493 *Export Declaration request at Export*

2.1.15.2 Event(s)

The table below defines the 'Event(s)' of the 'BP0005. Validate' process.

Element Name	Description	Special Type
BPE0027. A message or event notification from GUI is received for validation	Message input in the validation process.	Start
BPE0035. Validation completed successfully	The validation is completed successfully with no errors reported. The process terminates.	End
BPE0036. Validation completed with errors	The validation completed with errors. The process terminates.	End

2.1.15.3 Gateway(s)

The table below defines the 'Gateway(s)' of the 'BP0005. Validate' process.

Element Name	Description	Special Type
BPE0033. Merge Invalid Flows	Merge into exclusive event based gateway the invalid flows from all validation tasks.	Merge

CARM Customs Declaration and Excise Documents Processing system (CDEPS)	REF: CDEPS_EXPORT_BPS
Business Process Specifications for EXPORT System	VER:410

2.1.16.BP0246. Handle Pre-validation request

Business Process Description

The following table provides general information about the 'BP0246. Handle Pre-validation request' process. The Business Process Diagram and the description of various business process elements are specified in the following paragraphs.

Description	The process handles a request received from the Trader Portal for the pre-validation of any message. The process terminates with either a positive or negative reply back to the Trader Portal.
Precondition(s)	
Trigger	
Postcondition(s)	

Business Process Diagram

The Business Process Diagram of 'BP0246. Handle Pre-validation request' is shown below in BPMN notation. The definition of a process that might be used as sub-process by the 'BP0246. Handle Pre-validation request' can be found in this document. Finally, Annex A of CDEPS-BPS-EXPORT provides some explanatory information about the used notation.

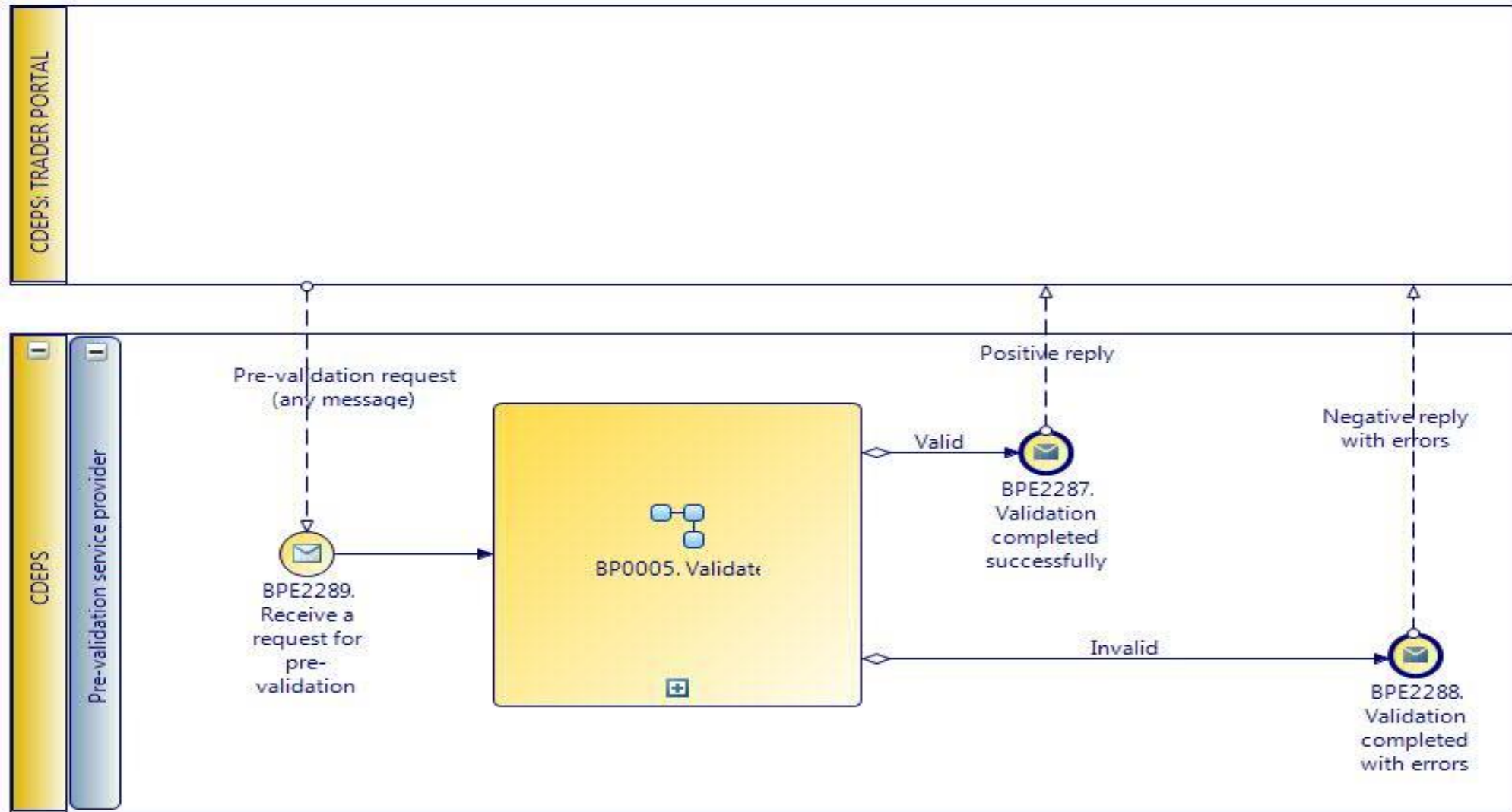

CARM Customs Declaration and Excise Documents Processing system (CDEPS)	REF: CDEPS_EXPORT_BPS
Business Process Specifications for EXPORT System	VER:410

2.1.16.1 Event(s)

The table below defines the 'Event(s)' of the 'BP0246. Handle Pre-validation request' process.

Element Name	Description	Special Type
BPE2287. Validation completed successfully	The validation is completed successfully with no errors reported. The process terminates and informs requesting system accordingly.	End
BPE2288. Validation completed with errors	The validation completed with errors. The process terminates and informs requesting system accordingly.	End
BPE2289. Receive a request for pre-validation	A pre-validation request is received from Trader Portal for a specific message.	Start

CARM Customs Declaration and Excise Documents Processing system (CDEPS)	REF: CDEPS_EXPORT_BPS
Business Process Specifications for EXPORT System	VER:410

2.1.17.BP0291. Handle initial Goods discharge and License/CVED usage registration

Business Process Description

The following table provides general information about the 'BP0291. Handle initial Goods discharge and License/CVED usage registration' process. The Business Process Diagram and the description of various business process elements are specified in the following paragraphs.

Description	The process describes the action performed by the system in order to credit the previous documents declared in the submitted document
Precondition(s)	Previous Documents are included in the declaration
Trigger	A credit on previous documents is required
Postcondition(s)	None

Business Process Diagram

The Business Process Diagram of 'BP0291. Handle initial Goods discharge and License/CVED usage registration' is shown below in BPMN notation. The definition of a process that might be used as sub-process by the 'BP0291. Handle initial Goods discharge and License/CVED usage registration' can be found in this document. Finally, Annex A of CDEPS-BPS-EXPORT provides some explanatory information about the used notation.

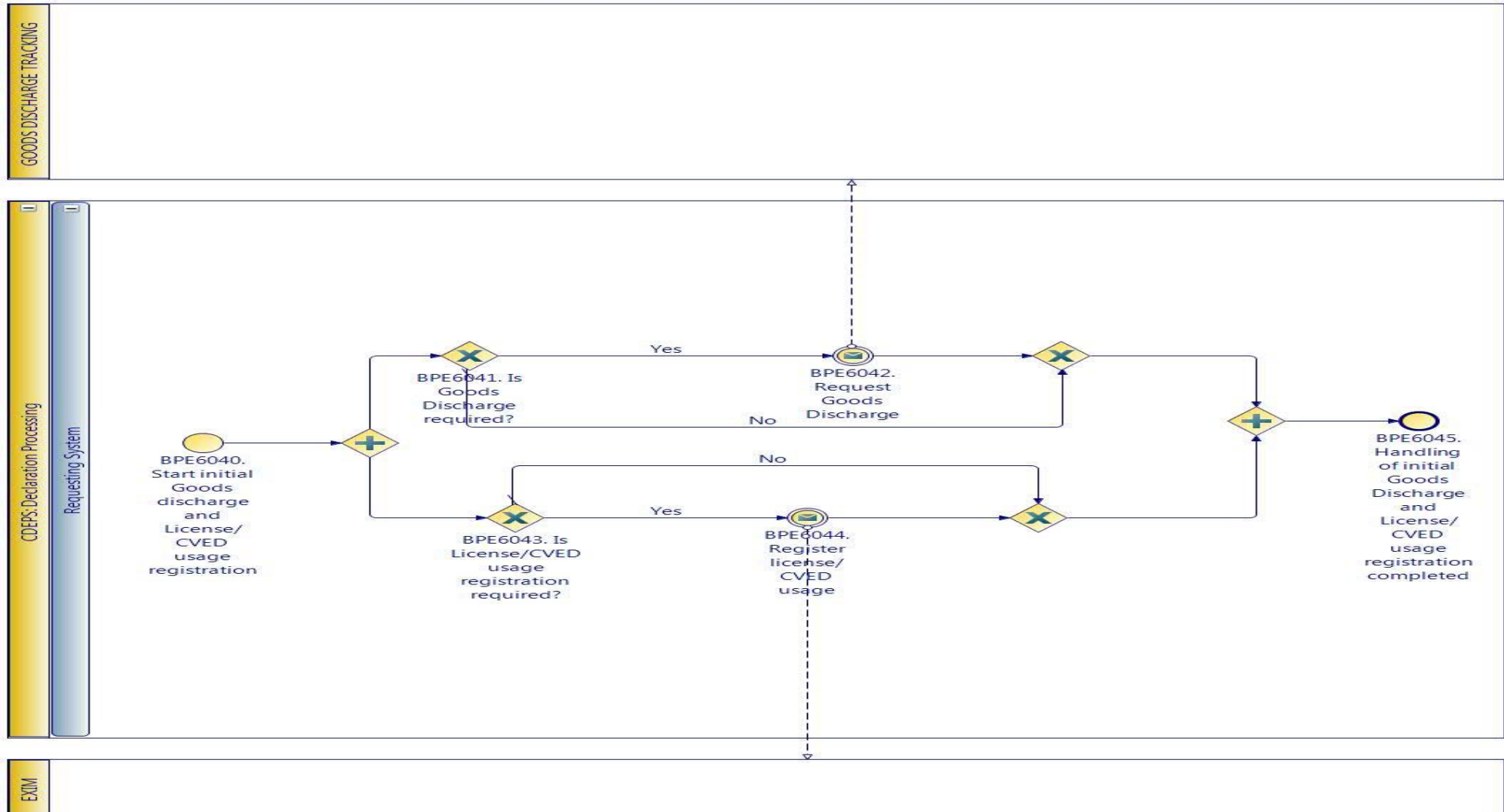

CARM Customs Declaration and Excise Documents Processing system (CDEPS)	REF: CDEPS_EXPORT_BPS
Business Process Specifications for EXPORT System	VER:410

2.1.17.1 Activities

The table below defines the 'Activities' of the 'BP0291. Handle initial Goods discharge and License/CVED usage registration' process.

Element Name	Description	Special Type
BPE3041. Report valid result	Report valid result	Service Task

2.1.17.2 Event(s)

The table below defines the 'Event(s)' of the 'BP0291. Handle initial Goods discharge and License/CVED usage registration' process.

Element Name	Description	Special Type
BPE6040. Start initial Goods discharge and License/CVED usage registration	This process is triggered by this start event for the registration of the declaration goods discharge and the license/CVED usage.	Start
BPE6042. Request Goods Discharge	The request for goods discharge is sent to the responsible for the goods discharge tracking system	Intermediate
BPE6044. Register license/CVED usage	The license/CVED usage is sent to EXIM to be registered	Intermediate
BPE6045. Handling of initial Goods Discharge and License/CVED usage registration completed	Handling of initial Goods Discharge and License/CVED usage registration completed	End

2.1.17.3 Gateway(s)

The table below defines the 'Gateway(s)' of the 'BP0291. Handle initial Goods discharge and License/CVED usage registration' process.

Element Name	Description	Special Type
BPE6041. Is Goods Discharge required?	A decision point in the process to navigate the flow based on whether a Goods Discharge Decision required?	
↳ Business Rule	425 Goods Discharge required	

CARM Customs Declaration and Excise Documents Processing system (CDEPS)		REF: CDEPS_EXPORT_BPS
Business Process Specifications for EXPORT System		VER:410
↳ Business Rule	499	<i>Goods Discharge required (Export/Import Specific)</i>
BPE6043. Is License/CVED usage registration required?	A decision point in the process to navigate the flow based on whether License/CVED usage registration required	Decision
↳ Business Rule	424	<i>License/CVED usage registration required</i>

CARM Customs Declaration and Excise Documents Processing system (CDEPS)	REF: CDEPS_EXPORT_BPS
Business Process Specifications for EXPORT System	VER:410

2.2. Process Group: Export Declaration processing at Exit

2.2.1.BP0138. Process Export Declaration @ Office of Exit

Business Process Description

The following table provides general information about the 'BP0138. Process Export Declaration @ Office of Exit' process. The Business Process Diagram and the description of various business process elements are specified in the following paragraphs.

Description	A high level process describing the actions performed by the system in order to process the export declaration at the Office of Exit.
Precondition(s)	None
Trigger	The process is triggered when the Anticipated Export Record is received at Office of Exit
Postcondition(s)	- None - AER Created

Business Process Diagram

The Business Process Diagram of 'BP0138. Process Export Declaration @ Office of Exit' is shown below in BPMN notation. The definition of a process that might be used as sub-process by the 'BP0138. Process Export Declaration @ Office of Exit' can be found in this document. Finally, Annex A of CDEPS-BPS-EXPORT provides some explanatory information about the used notation.

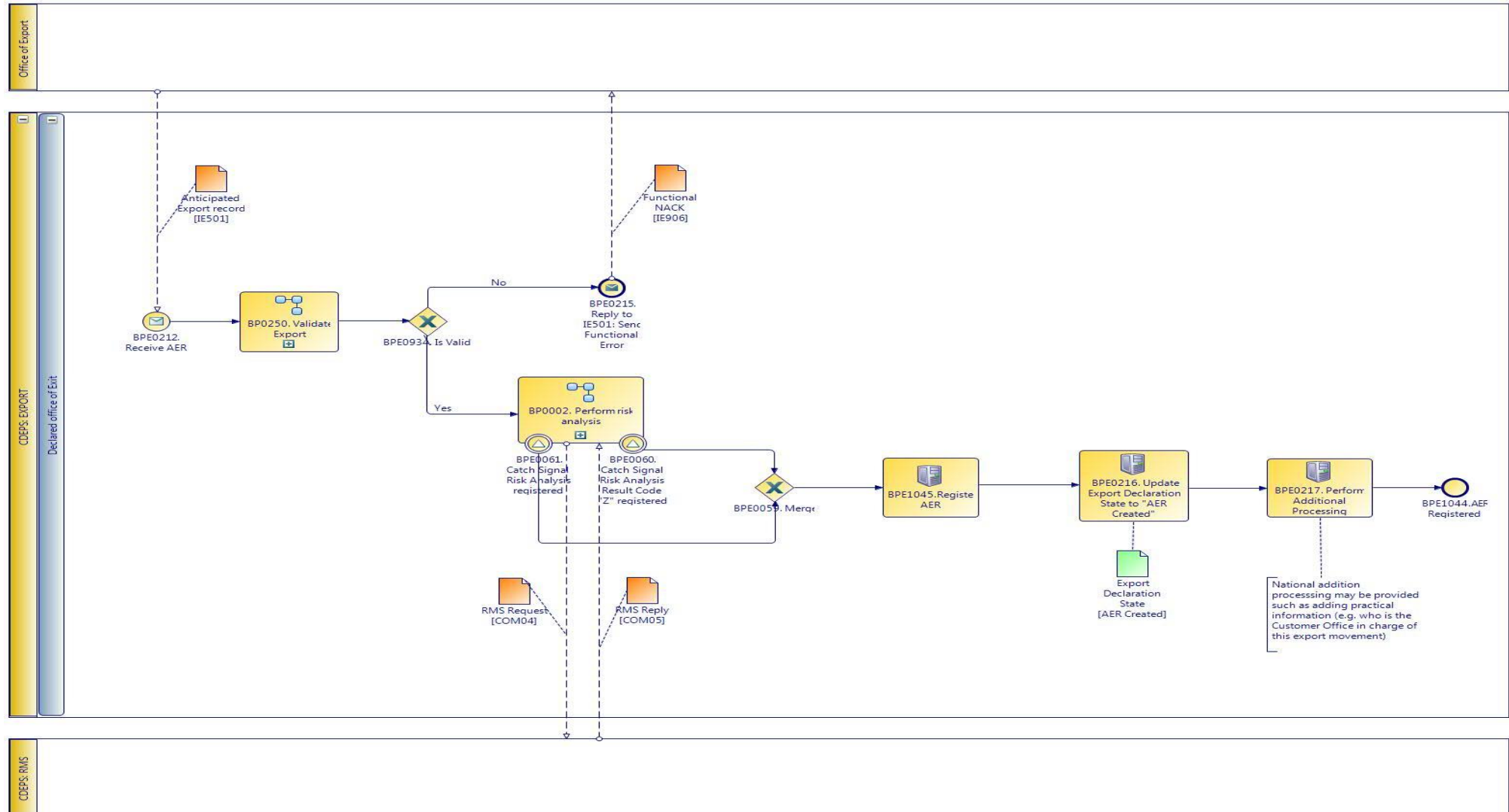

CARM Customs Declaration and Excise Documents Processing system (CDEPS)	REF: CDEPS_EXPORT_BPS
Business Process Specifications for EXPORT System	VER:410

2.2.1.1 Activities

The table below defines the 'Activities' of the 'BP0138. Process Export Declaration @ Office of Exit' process.

Element Name	Description	Special Type
BPE0216. Update Export Declaration State to "AER Created"	The system updates the state of the declaration to "AER Created" upon the AER successful validation.	
BPE0217. Perform Additional Processing	After automatic risk analysis, the Office of Exit may decide to complement the risk analysis results and/or to overrule the decision to control or not to control the goods upon arrival. Additional processing on national level may be provided such as adding practical information (e.g. who is the Customs Officer in charge of this export movement).	
BPE1045. Register AER	The system registers the AER upon its validation.	Service Task

2.2.1.2 Event(s)

The table below defines the 'Event(s)' of the 'BP0138. Process Export Declaration @ Office of Exit' process.

Element Name	Description	Special Type
BPE0212. Receive AER	The Declared Office of Exit receives the Anticipated Export Record from the Office of Export.	Start
BPE0215. Reply to IE501: Send Functional Error	Office of Export is notified of the AER validation errors through a Functional Error Message (IE906)	End
BPE1044. AER Registered	The AER is registered in the system	End

CARM Customs Declaration and Excise Documents Processing system (CDEPS)	REF: CDEPS_EXPORT_BPS
Business Process Specifications for EXPORT System	VER:410

2.2.1.3 Gateway(s)

The table below defines the 'Gateway(s)' of the 'BP0138. Process Export Declaration @ Office of Exit' process.

Element Name	Description	Special Type
BPE0934. Is Valid?	A decision point in the process to navigate the flow based on the message validation result.	Decision
↳ Business Rule 638	<i>Import declaration type 'X' cannot be cancelled</i>	
↳ Business Rule 646	<i>Guarantees during the registration of Import declaration type 'X'</i>	
↳ Business Rule 80	<i>Valid Message</i>	

CARM Customs Declaration and Excise Documents Processing system (CDEPS)	REF: CDEPS_EXPORT_BPS
Business Process Specifications for EXPORT System	VER:410

2.2.2.BP0250. Validate Export

Business Process Description

The following table provides general information about the 'BP0250. Validate Export' process. The Business Process Diagram and the description of various business process elements are specified in the following paragraphs.

Description	Reusable subprocess that performs the message validation tasks for Export Regime.
Precondition(s)	None
Trigger	The process is triggered when an electronic message is received for validation.
Postcondition(s)	The validation is either completed successfully or with errors reported

Business Process Diagram

The Business Process Diagram of 'BP0250. Validate Export' is shown below in BPMN notation. The definition of a process that might be used as sub-process by the 'BP0250. Validate Export' can be found in this document. Finally, Annex A of CDEPS-BPS-EXPORT provides some explanatory information about the used notation.

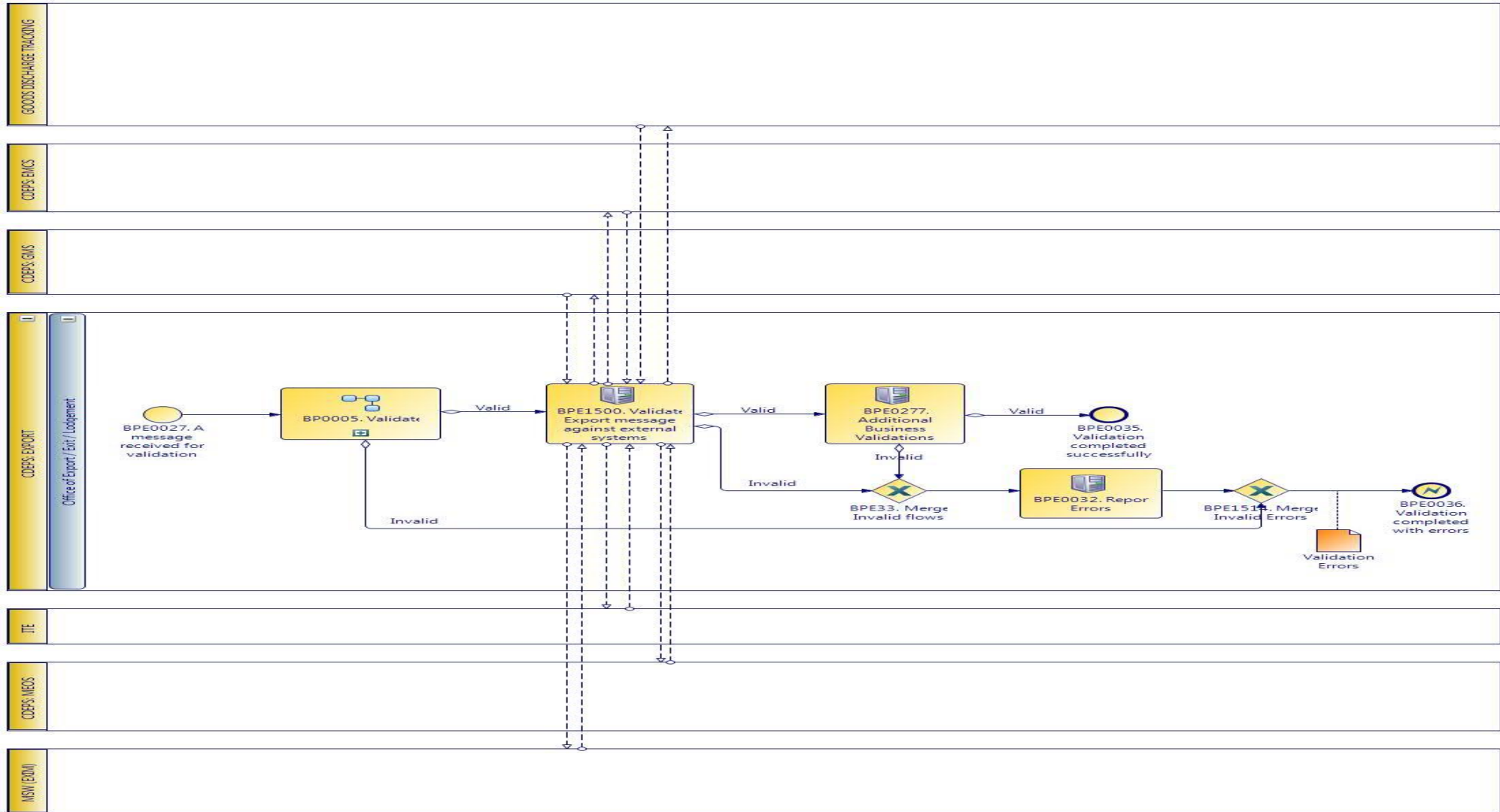

CARM Customs Declaration and Excise Documents Processing system (CDEPS)	REF: CDEPS_EXPORT_BPS
Business Process Specifications for EXPORT System	VER:410

2.2.2.1 Activities

The table below defines the 'Activities' of the 'BP0250. Validate Export' process.

Element Name	Description	Special Type
BPE0032. Report Errors	Report the identified errors from the validation process. The process terminates.	Service Task
BPE0277. Additional Business Validations for Export	The system performs any additional business validations specific to Export System.	Service Task
↳ Business Rule 19	Trader amending data same as Person lodging the declaration	
↳ Business Rule 21	Reject ENS/EXS amendment if ENS/EXS is not in appropriate state	
↳ Business Rule 245	Validate Personal ID	
↳ Business Rule 39	Cancellation Constraint	
↳ Business Rule 520	Import/ Export allowed guarantee types	
↳ Business Rule 70	EXS exists at the Office of Exit	
↳ Business Rule 71	Manifest number in IE547 and IE590	
BPE1500. Validate Export message against external systems	The system performs message validations against external systems.	Service Task
↳ Business Rule 101	Validate Economic Operator against MEOS	
↳ Business Rule 422	Validation of NCTS notifications	
↳ Business Rule 425	Goods Discharge required	
↳ Business Rule 439	Validate against GMS for integrity check	
↳ Business Rule 440	Validate Economic Operator's TIN against MEOS	
↳ Business Rule 494	Orchestrate validation of Export message against external systems	
↳ Business Rule 508	Validation of Export licenses with EXIM	

CARM Customs Declaration and Excise Documents Processing system (CDEPS)	REF: CDEPS_EXPORT_BPS
Business Process Specifications for EXPORT System	VER:410
↳ Business Rule 509	Check Export authorizations with MEOS
↳ Business Rule 51	Validate declared Combined Nomenclature in Declaration against ITE.
↳ Business Rule 510	Check Export authorizations for representation with MEOS
↳ Business Rule 511	Check Evidence of Power of Attorney with MEOS
↳ Business Rule 521	Validate Export declaration against ITE (duty calculation).
↳ Business Rule 522	Validate Export declaration data against Goods Discharge Tracking system
↳ Business Rule 527	Validate Export Declaration data against Excise system

2.2.2.2 Event(s)

The table below defines the 'Event(s)' of the 'BP0250. Validate Export' process.

Element Name	Description	Special Type
BPE0027. A message or event notification from GUI is received for validation	Message input in the validation process.	Start
BPE0035. Validation completed successfully	The validation is completed successfully with no errors reported. The process terminates.	End
BPE0036. Validation completed with errors	The validation completed with errors. The process terminates.	End

2.2.2.3 Gateway(s)

The table below defines the 'Gateway(s)' of the 'BP0250. Validate Export' process.

Element Name	Description	Special Type
BPE1514. Merge Invalid Errors	Combines exclusively either the negative outcome of generic validate process (BP0005. Validate) which reports errors or the errors from the extra checks for the specific system.	Merge

CARM Customs Declaration and Excise Documents Processing system (CDEPS)	REF: CDEPS_EXPORT_BPS
Business Process Specifications for EXPORT System	VER:410

2.2.3.BP0005. Validate

Business Process Description

The following table provides general information about the 'BP0005. Validate' process. The Business Process Diagram and the description of various business process elements are specified in the following paragraphs.

Description	Reusable subprocess that performs the message validation tasks
Precondition(s)	None
Trigger	The process is triggered when an electronic message is received for validation.
Postcondition(s)	

Business Process Diagram

The Business Process Diagram of 'BP0005. Validate' is shown below in BPMN notation. The definition of a process that might be used as sub-process by the 'BP0005. Validate' can be found in this document. Finally, Annex A of CDEPS-BPS-EXPORT provides some explanatory information about the used notation.

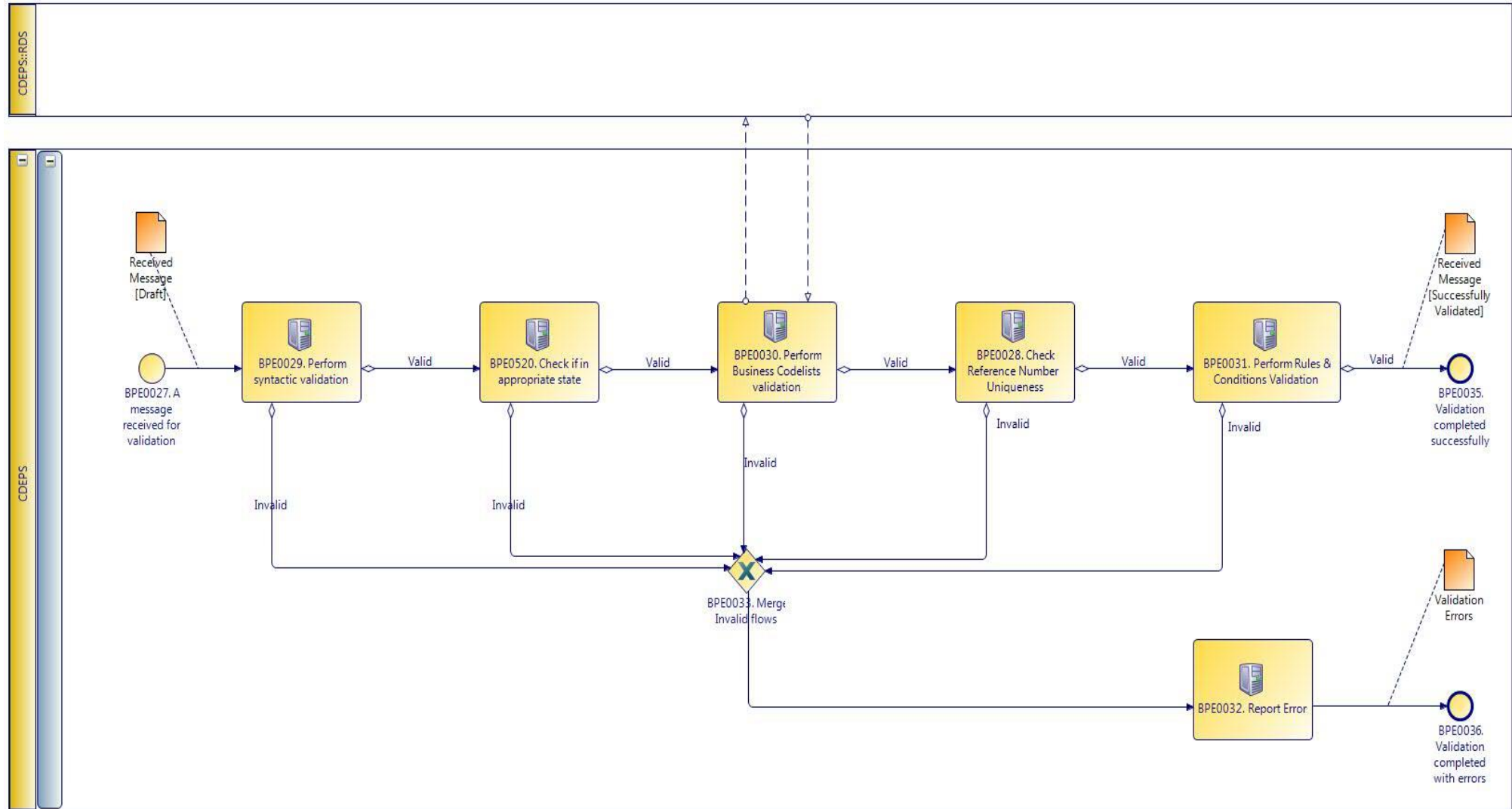

CARM Customs Declaration and Excise Documents Processing system (CDEPS)	REF: CDEPS_EXPORT_BPS
Business Process Specifications for EXPORT System	VER:410

2.2.3.1 Activities

The table below defines the 'Activities' of the 'BP0005. Validate' process.

Element Name	Description	Special Type
BPE0028. Check Reference Number Uniqueness	Check whether message reference numbers are unique in the system.	Service Task
↳ Business Rule 1	<i>Check Message Identification uniqueness</i>	
↳ Business Rule 74	<i>Check Local Reference Number (LRN) uniqueness</i>	
↳ Business Rule 75	<i>Check Movement Reference Number (MRN)uniqueness</i>	
↳ Business Rule 79	<i>Check Manifest reference number uniqueness</i>	
BPE0029. Perform syntactic validation	Check messages against the XSDs.	Service Task
↳ Business Rule 47	<i>Syntactic validation</i>	
BPE0030. Perform Business Codelists validation	Check the message business codelists.	Service Task
↳ Business Rule 50	<i>Business codelist validation against CDEPS:RDS</i>	
BPE0031. Perform Rules & Conditions Validation	Check the rules and conditions of the respective message.	Service Task
BPE0032. Report Errors	Report the identified errors from the validation process. The process terminates.	Service Task
BPE0520. Check if in appropriate state	Check whether the process for the particular entity (e.g. declaration/ application/ document) is on the appropriate state to process the received message. This check shall be performed based on the pertinent State Model of the system.	Service Task
↳ Business Rule 421	<i>Supplementary Declaration validation at Export</i>	
↳ Business Rule 448	<i>Check appropriate state for Export Declaration Amendment</i>	

CARM Customs Declaration and Excise Documents Processing system (CDEPS)	REF: CDEPS_EXPORT_BPS
Business Process Specifications for EXPORT System	VER:410

- ↳ **Business Rule** 449 *Check appropriate state Declaration Goods Presentation*
- ↳ **Business Rule** 468 *Guarantee Amendment*
- ↳ **Business Rule** 492 *Exit control results received at Export*
- ↳ **Business Rule** 493 *Export Declaration request at Export*

2.2.3.2 Event(s)

The table below defines the 'Event(s)' of the 'BP0005. Validate' process.

Element Name	Description	Special Type
BPE0027. A message or event notification from GUI is received for validation	Message input in the validation process.	Start
BPE0035. Validation completed successfully	The validation is completed successfully with no errors reported. The process terminates.	End
BPE0036. Validation completed with errors	The validation completed with errors. The process terminates.	End

2.2.3.3 Gateway(s)

The table below defines the 'Gateway(s)' of the 'BP0005. Validate' process.

Element Name	Description	Special Type
BPE0033. Merge Invalid Flows	Merge into exclusive event based gateway the invalid flows from all validation tasks.	Merge

CARM Customs Declaration and Excise Documents Processing system (CDEPS)	REF: CDEPS_EXPORT_BPS
Business Process Specifications for EXPORT System	VER:410

2.2.4.BP0246. Handle Pre-validation request

Business Process Description

The following table provides general information about the 'BP0246. Handle Pre-validation request' process. The Business Process Diagram and the description of various business process elements are specified in the following paragraphs.

Description	The process handles a request received from the Trader Portal for the pre-validation of any message. The process terminates with either a positive or negative reply back to the Trader Portal.
--------------------	---

Precondition(s)	
------------------------	--

Trigger	
----------------	--

Postcondition(s)	
-------------------------	--

Business Process Diagram

The Business Process Diagram of 'BP0246. Handle Pre-validation request' is shown below in BPMN notation. The definition of a process that might be used as sub-process by the 'BP0246. Handle Pre-validation request' can be found in this document. Finally, Annex A of CDEPS-BPS-EXPORT provides some explanatory information about the used notation.

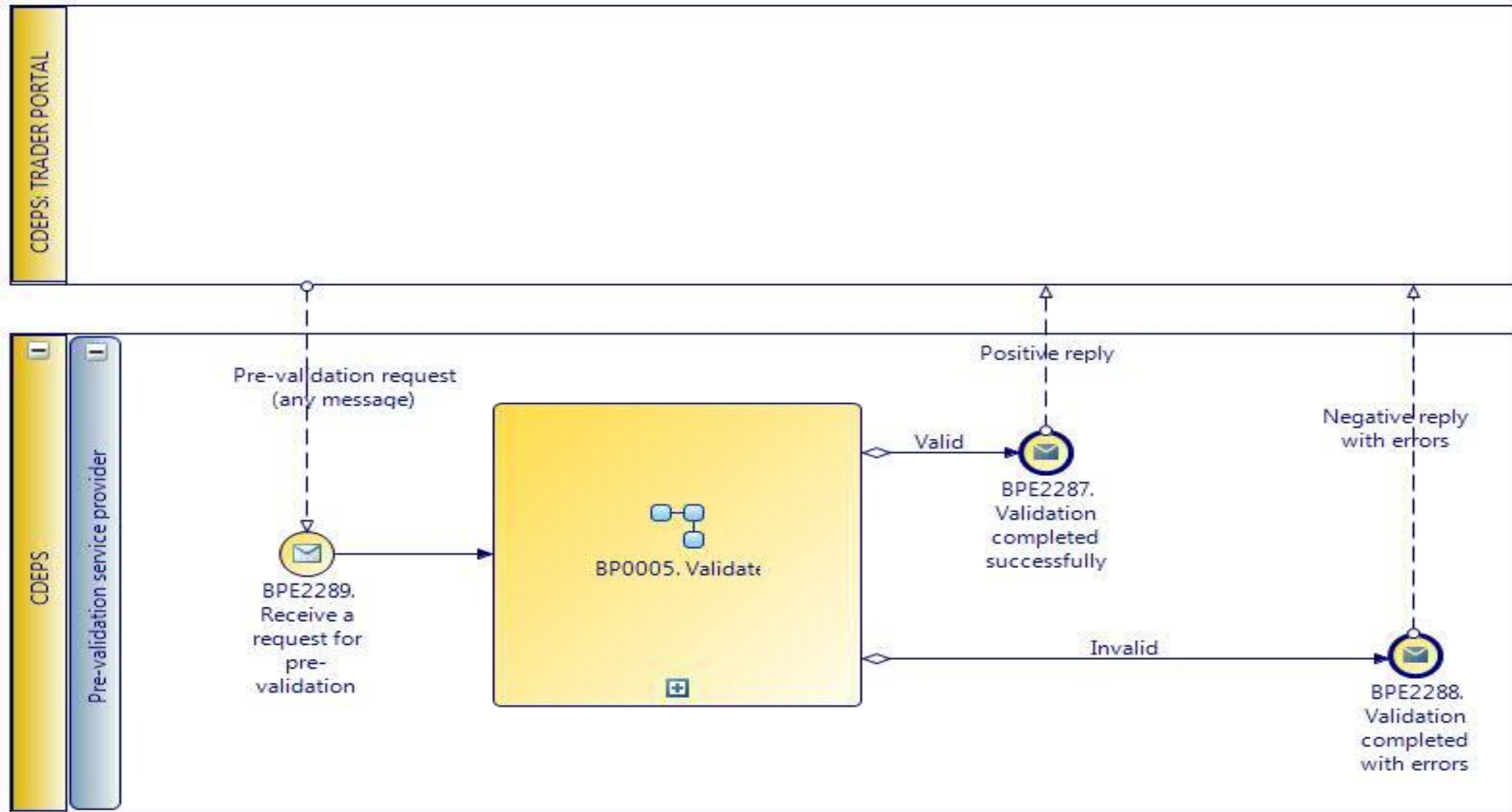

CARM Customs Declaration and Excise Documents Processing system (CDEPS)	REF: CDEPS_EXPORT_BPS
Business Process Specifications for EXPORT System	VER:410

2.2.4.1 Event(s)

The table below defines the 'Event(s)' of the 'BP0246. Handle Pre-validation request' process.

Element Name	Description	Special Type
BPE2287. Validation completed successfully	The validation is completed successfully with no errors reported. The process terminates and informs requesting system accordingly.	End
BPE2288. Validation completed with errors	The validation completed with errors. The process terminates and informs requesting system accordingly.	End
BPE2289. Receive a request for pre-validation	A pre-validation request is received from Trader Portal for a specific message.	Start

CARM Customs Declaration and Excise Documents Processing system (CDEPS)	REF: CDEPS_EXPORT_BPS
Business Process Specifications for EXPORT System	VER:410

2.3. Process Group: Export Declaration arrival at Exit

2.3.1.BP0141. Process Arrival @ Actual Office of Exit

Business Process Description

The following table provides general information about the 'BP0141. Process Arrival @ Actual Office of Exit' process. The Business Process Diagram and the description of various business process elements are specified in the following paragraphs.

Description	A high level process describing the actions performed by the system in order to process the arrival at the Actual Office of Exit.
Precondition(s)	None
Trigger	The process is triggered by the reception of either an electronic arrival notification by the Trader or manually by the Customs Officer
Postcondition(s)	<ul style="list-style-type: none"> - Goods not Presented at Exit - Goods held for Storing - Goods Released for Immediate Leave

Business Process Diagram

The Business Process Diagram of 'BP0141. Process Arrival @ Actual Office of Exit' is shown below in BPMN notation. The definition of a process that might be used as sub-process by the 'BP0141. Process Arrival @ Actual Office of Exit' can be found in this document. Finally, Annex A of CDEPS-BPS-EXPORT provides some explanatory information about the used notation.

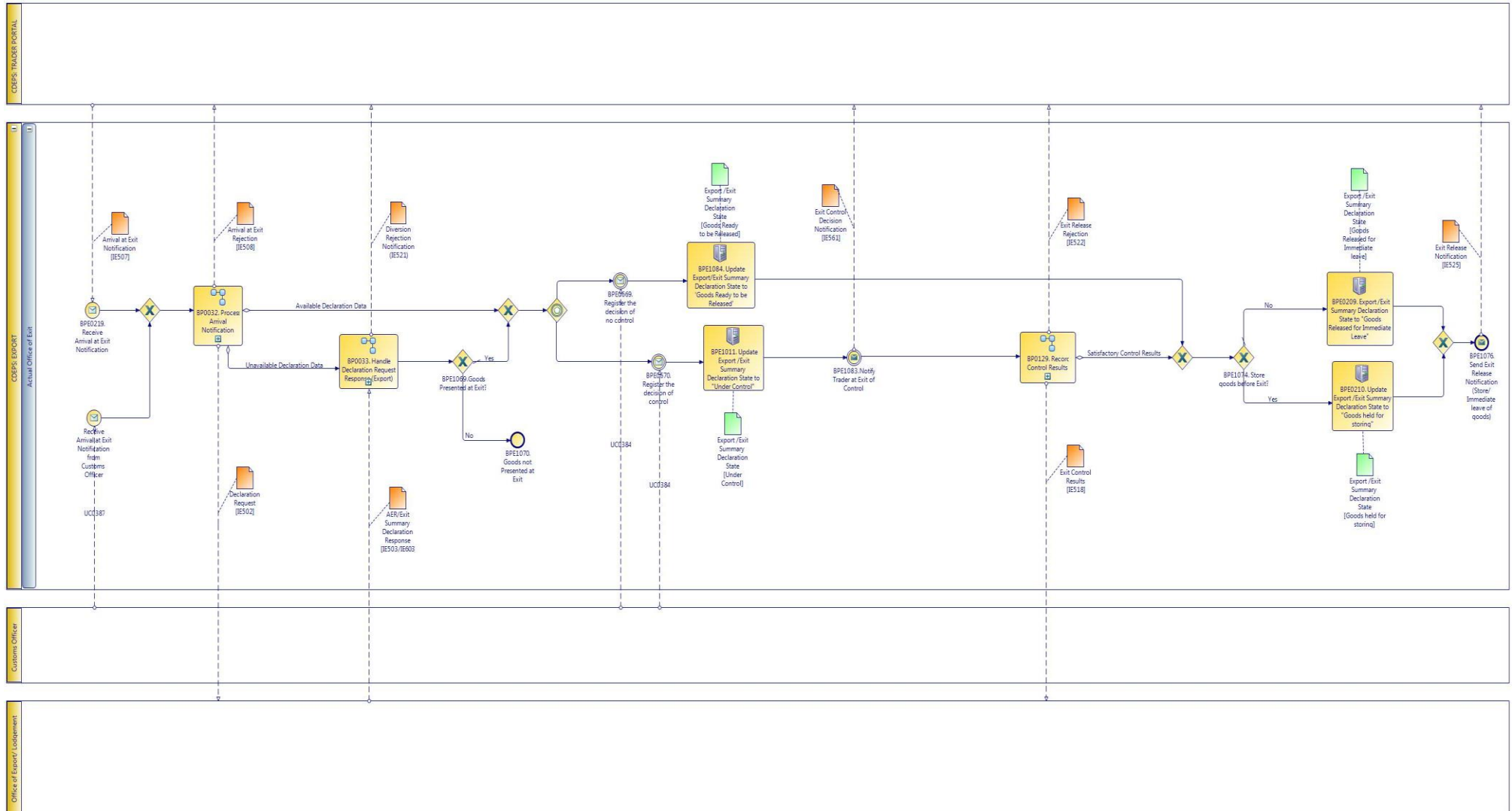

CARM Customs Declaration and Excise Documents Processing system (CDEPS)	REF: CDEPS_EXPORT_BPS
Business Process Specifications for EXPORT System	VER:410

2.3.1.1 Activities

The table below defines the 'Activities' of the 'BP0141. Process Arrival @ Actual Office of Exit' process.

Element Name	Description	Special Type
BPE0209. Update Export /Exit Summary Declaration State to "Goods Released for Immediate Leave"	The system updates the Export /Exit Summary Declaration State to "Goods released for immediate leave".	
BPE0210. Update Export /Exit Summary Declaration State to "Goods held for storing"	The system updates the Export /Exit Summary Declaration State to "Goods held for storing".	
BPE1011. Update Export /Exit Summary Declaration State to "Under Control"	The system updates the Export /Exit Summary Declaration State to "Under Control" upon the customs officer's decision to control.	Service Task

2.3.1.2 Event(s)

The table below defines the 'Event(s)' of the 'BP0141. Process Arrival @ Actual Office of Exit' process.

Element Name	Description	Special Type
BPE0219. Receive Arrival at Exit Notification	Office of Exit receives an arrival notification from the premises of the Trader at Exit (Carrier)	Start
BPE0669. Register the decision of no control	The Customs Officer at Office of Exit registers his decision no to control the goods.	Intermediate
BPE0670. Register the decision of control	The Customs Officer at Office of Exit registers his decision to control the goods.	Intermediate
BPE1070. Goods not Presented at Exit	The Goods are not presented at Exit and the AER/EXS is rejected. The process ends.	End

CARM Customs Declaration and Excise Documents Processing system (CDEPS)	REF: CDEPS_EXPORT_BPS
Business Process Specifications for EXPORT System	VER:410

BPE1076. Send Exit Release Notification (Store/Immediate leave of goods) The system sends an Exit Release Notification to Trader to communicate the release of the goods. End

BPE1083. Notify Trader at Exit of Control The system sends a notification to Trader at Exit to communicate the decision for control at Exit. Intermediate

2.3.1.3 Gateway(s)

The table below defines the 'Gateway(s)' of the 'BP0141. Process Arrival @ Actual Office of Exit' process.

Element Name	Description	Special Type
BPE1069. Goods Presented at Exit?	A decision point on the flow to decide whether the goods are presented at Exit based on the outgoing flow of the precedent process.	Decision
BPE1074. Store goods before Exit?	A decision gateway to decide whether the goods will be held for storing before exit or will be released for immediate leave.	Decision

CARM Customs Declaration and Excise Documents Processing system (CDEPS)	REF: CDEPS_EXPORT_BPS
Business Process Specifications for EXPORT System	VER:410

2.3.2.BP0032. Process Arrival Notification

Business Process Description

The following table provides general information about the 'BP0032. Process Arrival Notification' process. The Business Process Diagram and the description of various business process elements are specified in the following paragraphs.

Description	Goods are presented (IE507) to the Office of Exit (trader sends this message in the OfExt) either for immediately leaving the Community or for being stored in a warehouse prior to their exit.
Precondition(s)	Arrival Notification received
Trigger	The process starts when the Office of Exit has received the Arrival Notification.
Postcondition(s)	<ul style="list-style-type: none"> - Arrival Notification Rejected - Goods Presented at Exit - AER Requested

Business Process Diagram

The Business Process Diagram of 'BP0032. Process Arrival Notification' is shown below in BPMN notation. The definition of a process that might be used as sub-process by the 'BP0032. Process Arrival Notification' can be found in this document. Finally, Annex A of CDEPS-BPS-EXPORT provides some explanatory information about the used notation.

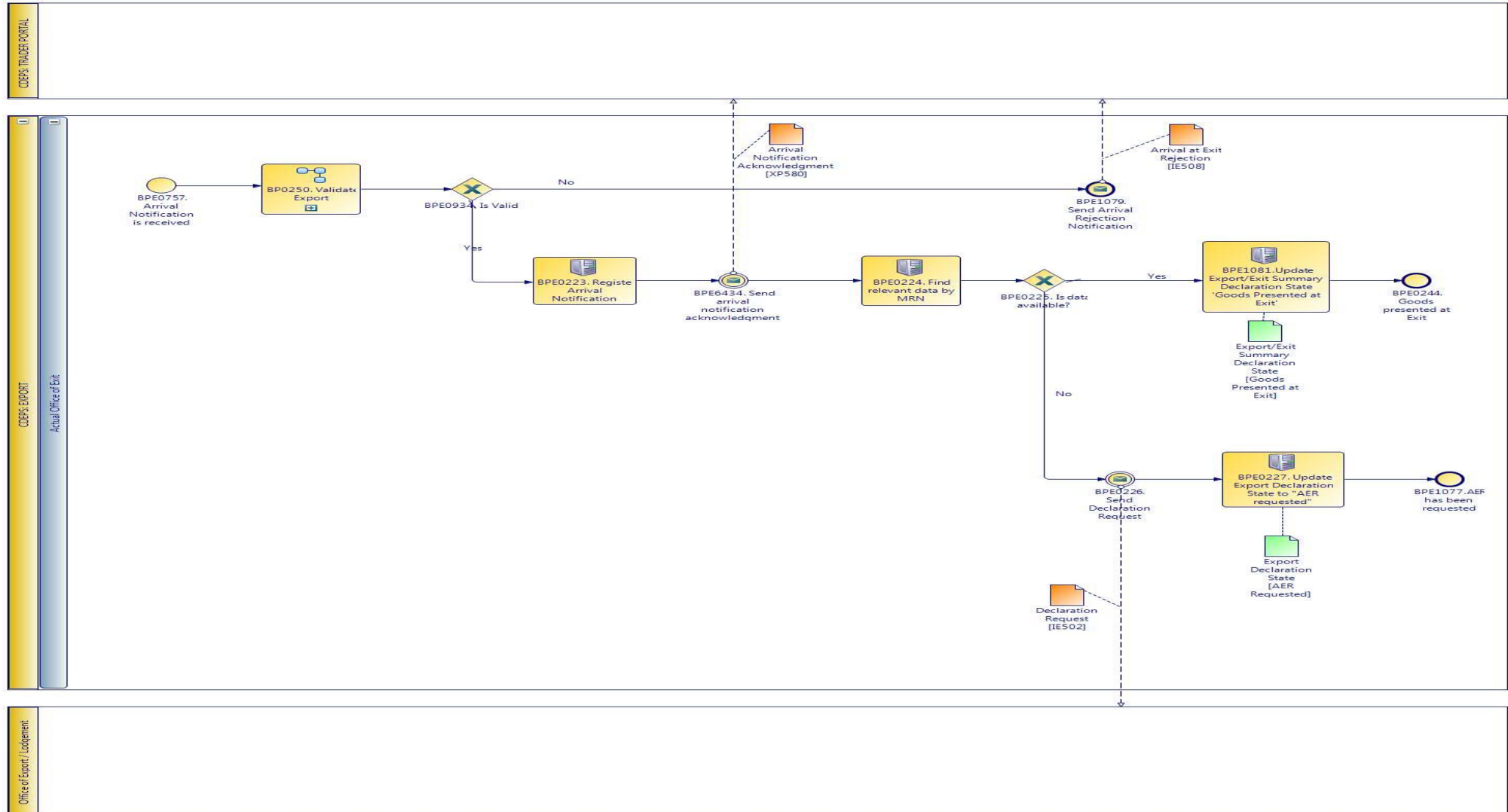

CARM Customs Declaration and Excise Documents Processing system (CDEPS)	REF: CDEPS_EXPORT_BPS
Business Process Specifications for EXPORT System	VER:410

2.3.2.1 Activities

The table below defines the 'Activities' of the 'BP0032. Process Arrival Notification' process.

Element Name	Description	Special Type
BPE0223. Register Arrival Notification	Validation is successful, arrival notification is registered	Service Task
BPE0224. Find relevant data by MRN	Query database to find relevant data by MRN	Service Task
BPE0227. Update Export Declaration State to "AER requested"	The system updates the Export Declaration State to "AER requested"	Service Task
BPE1081. Update Export/Exit Summary Declaration State to 'Goods Presented at Exit'	The system updates the Export/Exit Summary Declaration State to 'Goods Presented at Exit'	Service Task

2.3.2.2 Event(s)

The table below defines the 'Event(s)' of the 'BP0032. Process Arrival Notification' process.

Element Name	Description	Special Type
BPE0226. Send Declaration Request	Data not found, declaration request is sent to the Office of Export	Intermediate
BPE0244. Goods presented at Exit	Final state signaling that goods presented at Exit	End
BPE0757. Arrival Notification is received	The Arrival Notification is received at Actual Office of Exit.	Start
BPE1077. AER has been requested	The AER has been requested from the Office of Export and the process terminates.	End
BPE1079. Send Arrival Rejection Notification	The Arrival notification failed the validations and the Trader is notified about the rejection. End	

CARM Customs Declaration and Excise Documents Processing system (CDEPS)	REF: CDEPS_EXPORT_BPS
Business Process Specifications for EXPORT System	VER:410

BPE6434. Send arrival notification acknowledgment Send arrival notification acknowledgment Intermediate

2.3.2.3 Gateway(s)

The table below defines the 'Gateway(s)' of the 'BP0032. Process Arrival Notification' process.

Element Name	Description	Special Type
BPE0225. Is data available?	Check if relevant Export data is found based on the MRN provided	Decision
↳ Business Rule 62	<i>Locate movement in the OoExt</i>	
BPE0934. Is Valid?	A decision point in the process to navigate the flow based on the message validation result.	Decision
↳ Business Rule 638	<i>Import declaration type 'X' cannot be cancelled</i>	
↳ Business Rule 646	<i>Guarantees during the registration of Import declaration type 'X'</i>	
↳ Business Rule 80	<i>Valid Message</i>	

CARM Customs Declaration and Excise Documents Processing system (CDEPS)	REF: CDEPS_EXPORT_BPS
Business Process Specifications for EXPORT System	VER:410

2.3.3.BP0250. Validate Export

Business Process Description

The following table provides general information about the 'BP0250. Validate Export' process. The Business Process Diagram and the description of various business process elements are specified in the following paragraphs.

Description	Reusable subprocess that performs the message validation tasks for Export Regime.
Precondition(s)	None
Trigger	The process is triggered when an electronic message is received for validation.
Postcondition(s)	The validation is either completed successfully or with errors reported

Business Process Diagram

The Business Process Diagram of 'BP0250. Validate Export' is shown below in BPMN notation. The definition of a process that might be used as sub-process by the 'BP0250. Validate Export' can be found in this document. Finally, Annex A of CDEPS-BPS-EXPORT provides some explanatory information about the used notation.

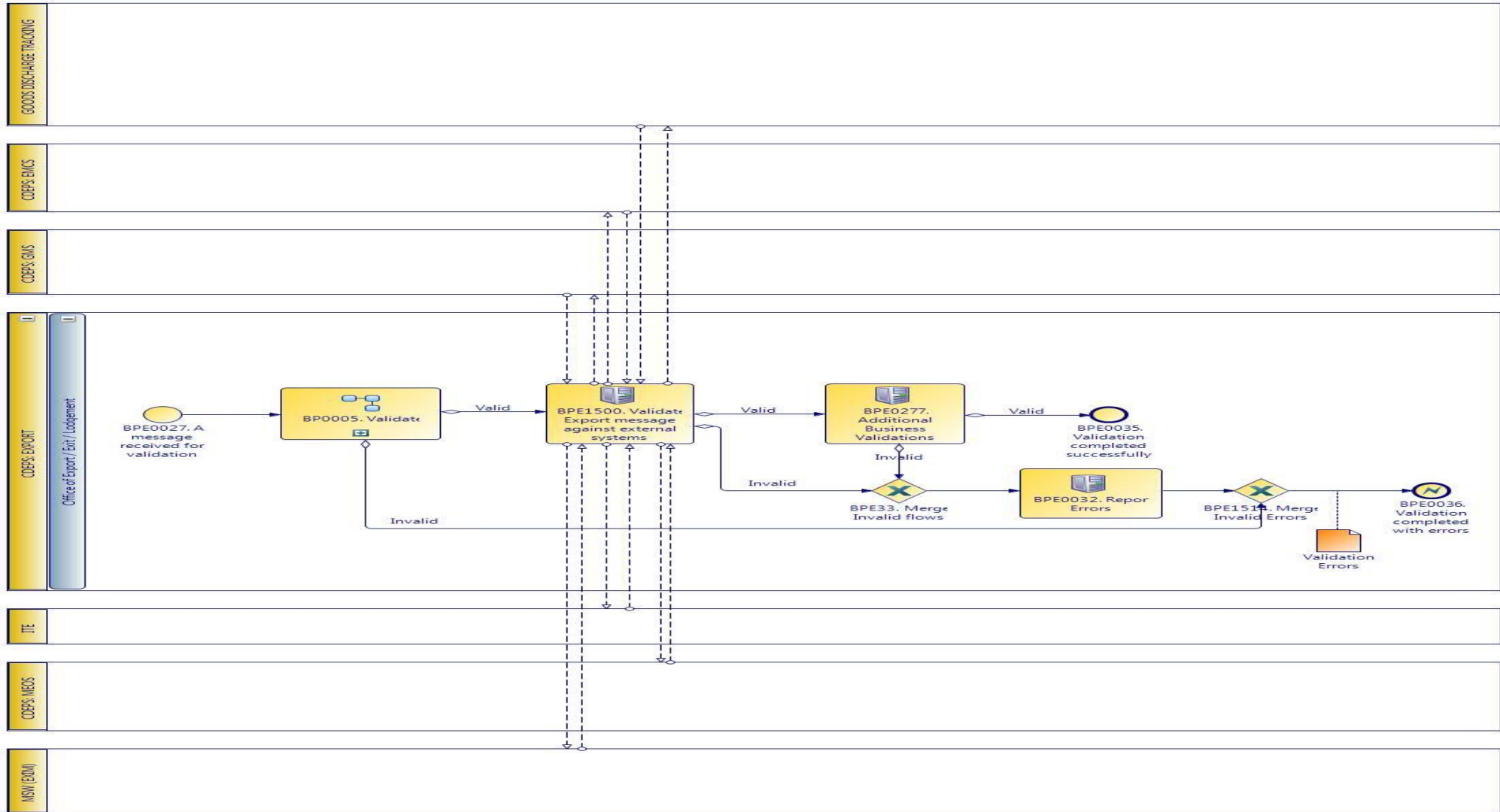

CARM Customs Declaration and Excise Documents Processing system (CDEPS)	REF: CDEPS_EXPORT_BPS
Business Process Specifications for EXPORT System	VER:410

2.3.3.1 Activities

The table below defines the 'Activities' of the 'BP0250. Validate Export' process.

Element Name	Description	Special Type
BPE0032. Report Errors	Report the identified errors from the validation process. The process terminates.	Service Task
BPE0277. Additional Business Validations for Export	The system performs any additional business validations specific to Export System.	Service Task
↳ Business Rule 19	Trader amending data same as Person lodging the declaration	
↳ Business Rule 21	Reject ENS/EXS amendment if ENS/EXS is not in appropriate state	
↳ Business Rule 245	Validate Personal ID	
↳ Business Rule 39	Cancellation Constraint	
↳ Business Rule 520	Import/ Export allowed guarantee types	
↳ Business Rule 70	EXS exists at the Office of Exit	
↳ Business Rule 71	Manifest number in IE547 and IE590	
BPE1500. Validate Export message against external systems	The system performs message validations against external systems.	Service Task
↳ Business Rule 101	Validate Economic Operator against MEOS	
↳ Business Rule 422	Validation of NCTS notifications	
↳ Business Rule 425	Goods Discharge required	
↳ Business Rule 439	Validate against GMS for integrity check	
↳ Business Rule 440	Validate Economic Operator's TIN against MEOS	
↳ Business Rule 494	Orchestrate validation of Export message against external systems	
↳ Business Rule 508	Validation of Export licenses with EXIM	

CARM Customs Declaration and Excise Documents Processing system (CDEPS)	REF: CDEPS_EXPORT_BPS
Business Process Specifications for EXPORT System	VER:410
↳ Business Rule 509	Check Export authorizations with MEOS
↳ Business Rule 51	Validate declared Combined Nomenclature in Declaration against ITE.
↳ Business Rule 510	Check Export authorizations for representation with MEOS
↳ Business Rule 511	Check Evidence of Power of Attorney with MEOS
↳ Business Rule 521	Validate Export declaration against ITE (duty calculation).
↳ Business Rule 522	Validate Export declaration data against Goods Discharge Tracking system
↳ Business Rule 527	Validate Export Declaration data against Excise system

2.3.3.2 Event(s)

The table below defines the 'Event(s)' of the 'BP0250. Validate Export' process.

Element Name	Description	Special Type
BPE0027. A message or event notification from GUI is received for validation	Message input in the validation process.	Start
BPE0035. Validation completed successfully	The validation is completed successfully with no errors reported. The process terminates.	End
BPE0036. Validation completed with errors	The validation completed with errors. The process terminates.	End

2.3.3.3 Gateway(s)

The table below defines the 'Gateway(s)' of the 'BP0250. Validate Export' process.

Element Name	Description	Special Type
BPE1514. Merge Invalid Errors	Combines exclusively either the negative outcome of generic validate process (BP0005. Validate) which reports errors or the errors from the extra checks for the specific system.	Merge

CARM Customs Declaration and Excise Documents Processing system (CDEPS)	REF: CDEPS_EXPORT_BPS
Business Process Specifications for EXPORT System	VER:410

2.3.4.BP0033. Handle Declaration Request Response (Export)

Business Process Description

The following table provides general information about the 'BP0033. Handle Declaration Request Response (Export)' process. The Business Process Diagram and the description of various business process elements are specified in the following paragraphs.

Description	The Office of Exit receives the export or exit summary declaration response from the Country of Export or Lodgement.
Precondition(s)	- AER Requested
Trigger	The system receives the response to the declaration request
Postcondition(s)	- None - Diversion Rejected - Goods Presented at Exit

Business Process Diagram

The Business Process Diagram of 'BP0033. Handle Declaration Request Response (Export)' is shown below in BPMN notation. The definition of a process that might be used as sub-process by the 'BP0033. Handle Declaration Request Response (Export)' can be found in this document. Finally, Annex A of CDEPS-BPS-EXPORT provides some explanatory information about the used notation.

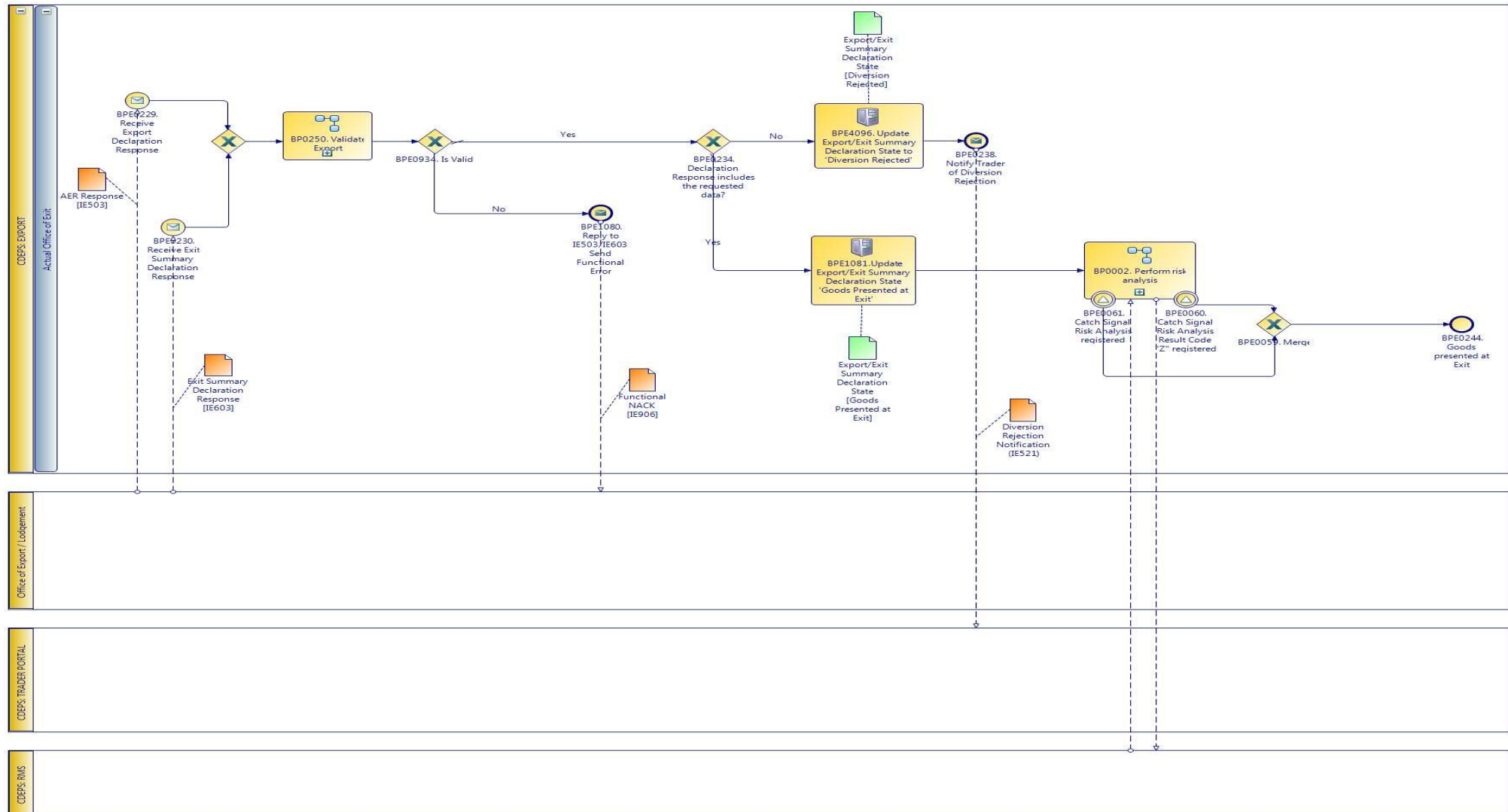

CARM Customs Declaration and Excise Documents Processing system (CDEPS)	REF: CDEPS_EXPORT_BPS
Business Process Specifications for EXPORT System	VER:410

2.3.4.1 Activities

The table below defines the 'Activities' of the 'BP0033. Handle Declaration Request Response (Export)' process.

Element Name	Description	Special Type
BPE1081. Update Export/Exit Summary Declaration State to 'Goods Presented at Exit'	The system updates the Export/Exit Summary Declaration State to 'Goods Presented at Exit'	Service Task
BPE4096. Update Export/Exit Summary Declaration State to 'Diversion Rejected'	The system updates the state of the declaration to 'Diversion Rejected'	Service Task

2.3.4.2 Event(s)

The table below defines the 'Event(s)' of the 'BP0033. Handle Declaration Request Response (Export)' process.

Element Name	Description	Special Type
BPE0229. Receive Export Declaration Response	In case data relates to Export declaration (it can be positive or negative response)	Start
BPE0230. Receive Exit Summary Declaration Response	In case data relates to Exit Summary Declaration (it can be positive or negative response)	Start
BPE0238. Notify Trader of Diversion Rejection	Diversion rejection notification is sent to the Trader at Exit	End
BPE0244. Goods presented at Exit	Final state signaling that goods presented at Exit	End
BPE1080. Reply to IE503/IE603 : Send Functional Error	The Export/Exit Summary declaration response failed the validations and the Office of Export/Lodgement is notified accordingly.	End

CARM Customs Declaration and Excise Documents Processing system (CDEPS)	REF: CDEPS_EXPORT_BPS
Business Process Specifications for EXPORT System	VER:410

2.3.4.3 Gateway(s)

The table below defines the 'Gateway(s)' of the 'BP0033. Handle Declaration Request Response (Export)' process.

Element Name	Description	Special Type
BPE0059. Merge	Merge risk analysis completion signals	Merge
BPE0234. Declaration Response includes the requested data?	Check if Declaration Response includes the requested data and decide	Decision
↳ Business Rule 61	<i>Notify diversion to the OoExt</i>	
BPE0934. Is Valid?	A decision point in the process to navigate the flow based on the message validation result.	Decision
↳ Business Rule 638	<i>Import declaration type 'X' cannot be cancelled</i>	
↳ Business Rule 646	<i>Guarantees during the registration of Import declaration type 'X'</i>	
↳ Business Rule 80	<i>Valid Message</i>	

CARM Customs Declaration and Excise Documents Processing system (CDEPS)	REF: CDEPS_EXPORT_BPS
Business Process Specifications for EXPORT System	VER:410

2.3.5.BP0129. Record Control Results

Business Process Description

The following table provides general information about the 'BP0129. Record Control Results' process. The Business Process Diagram and the description of various business process elements are specified in the following paragraphs.

Description	The Custom Officer records the Control Results Control results of type 'A' (satisfactory or minor discrepancies): the system records that the goods are ready to be released. In case of minor discrepancies, the goods may also be ready to be released for exit. Control results of type 'B' (not satisfactory): The Office of Export is notified about the exit control results (IE518 reporting the detected discrepancies) and the goods may not be released for exit;
Precondition(s)	Control of goods is finalised
Trigger	The process is triggered when the Customs Officer selects to register the Exit Control Results
Postcondition(s)	- Goods Ready to be Released - Goods not Allowed to Exit

Business Process Diagram

The Business Process Diagram of 'BP0129. Record Control Results' is shown below in BPMN notation. The definition of a process that might be used as sub-process by the 'BP0129. Record Control Results' can be found in this document. Finally, Annex A of CDEPS-BPS-EXPORT provides some explanatory information about the used notation.

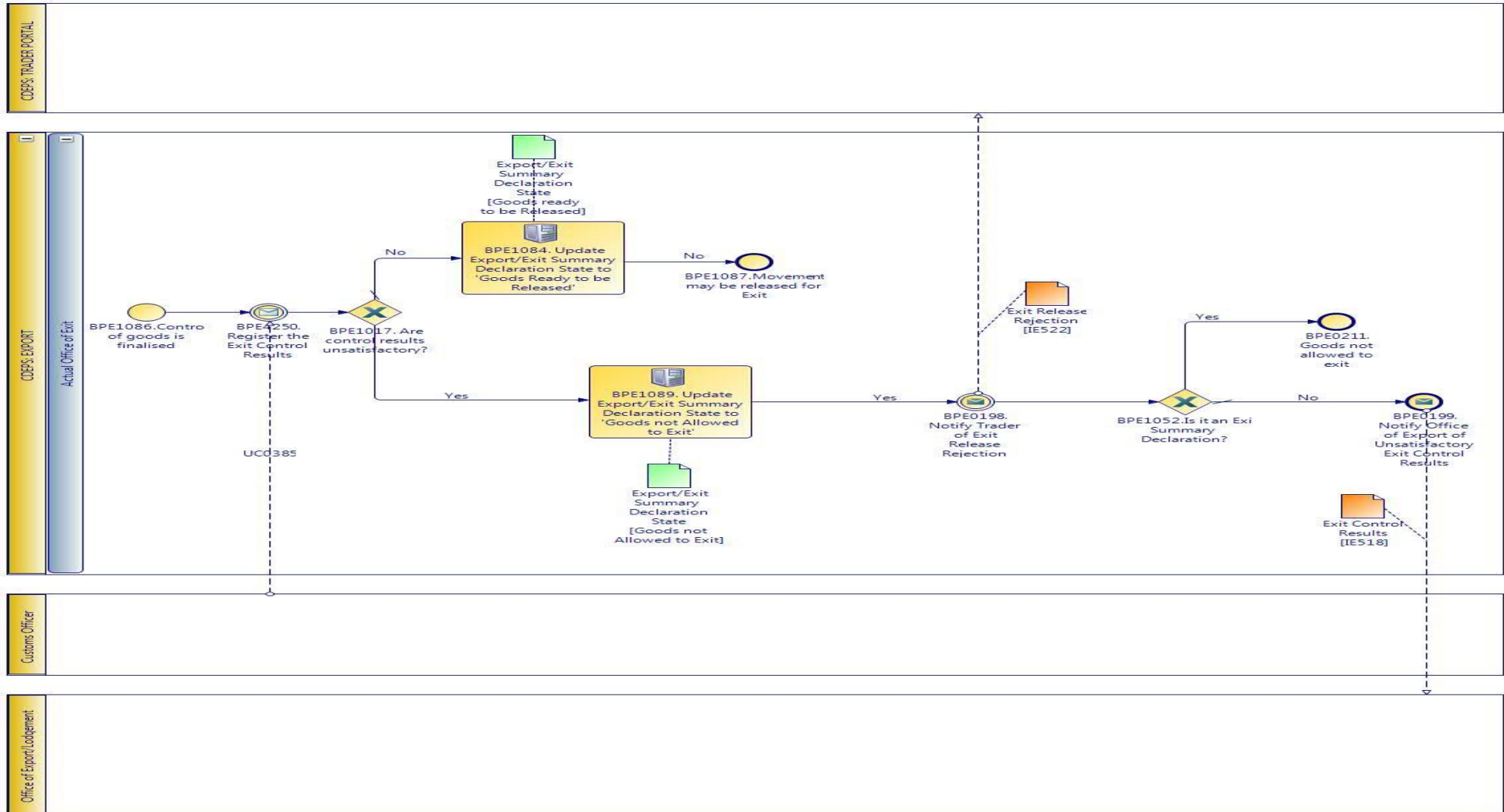

CARM Customs Declaration and Excise Documents Processing system (CDEPS)	REF: CDEPS_EXPORT_BPS
Business Process Specifications for EXPORT System	VER:410

2.3.5.1 Activities

The table below defines the 'Activities' of the 'BP0129. Record Control Results' process.

Element Name	Description	Special Type
BPE1089. Update Export/Exit Summary Declaration State to 'Goods not Allowed to Exit'	The control results are satisfactory and the system updates the state of the declaration to 'Goods not Allowed to Exit'.	Service Task

2.3.5.2 Event(s)

The table below defines the 'Event(s)' of the 'BP0129. Record Control Results' process.

Element Name	Description	Special Type
BPE0198. Notify Trader of Exit Release Rejection	Control results are not satisfactory, Trader at Exit is notified that goods are stopped at exit	Intermediate
BPE0199. Notify Office of Export of Unsatisfactory Exit Control Results	Office of Export is notified of unsatisfactory exit control results	End
BPE0211. Goods not allowed to exit	Control results are not satisfactory in the exit process, goods are stopped	End
BPE1086. Control of goods is finalised	The goods have been controlled.	Start
BPE1087. Movement may be released for Exit	The control results are satisfactory and the movement may be released for Exit. The process terminates.	End
BPE4250. Register the Exit Control Results	The Customs Officer registers the exit control results to the system	Intermediate

CARM Customs Declaration and Excise Documents Processing system (CDEPS)	REF: CDEPS_EXPORT_BPS
Business Process Specifications for EXPORT System	VER:410

2.3.5.3 Gateway(s)

The table below defines the 'Gateway(s)' of the 'BP0129. Record Control Results' process.

Element Name	Description	Special Type
BPE1017. Are control results unsatisfactory?	A decision point in the process to navigate the flow based on whether the control results are satisfactory or not.	Decision
BPE1052. Is it an Exit Summary Declaration?	A decision point on the process to navigate the flow based on the type of the declaration (Export or Exit Summary).	Decision

CARM Customs Declaration and Excise Documents Processing system (CDEPS)	REF: CDEPS_EXPORT_BPS
Business Process Specifications for EXPORT System	VER:410

2.3.6.BP0140. Process Arrival Advice @ Declared Office of Exit

Business Process Description

The following table provides general information about the 'BP0140. Process Arrival Advice @ Declared Office of Exit' process. The Business Process Diagram and the description of various business process elements are specified in the following paragraphs.

Description	A high level process describing the actions performed by the system in order to process the arrival advice at the Declared Office of Exit.
Precondition(s)	None
Trigger	The process is triggered by the Forwarded Arrival Advice received by the Office of Export
Postcondition(s)	- None - Arrived Elsewhere

Business Process Diagram

The Business Process Diagram of 'BP0140. Process Arrival Advice @ Declared Office of Exit' is shown below in BPMN notation. The definition of a process that might be used as sub-process by the 'BP0140. Process Arrival Advice @ Declared Office of Exit' can be found in this document. Finally, Annex A of CDEPS-BPS-EXPORT provides some explanatory information about the used notation.

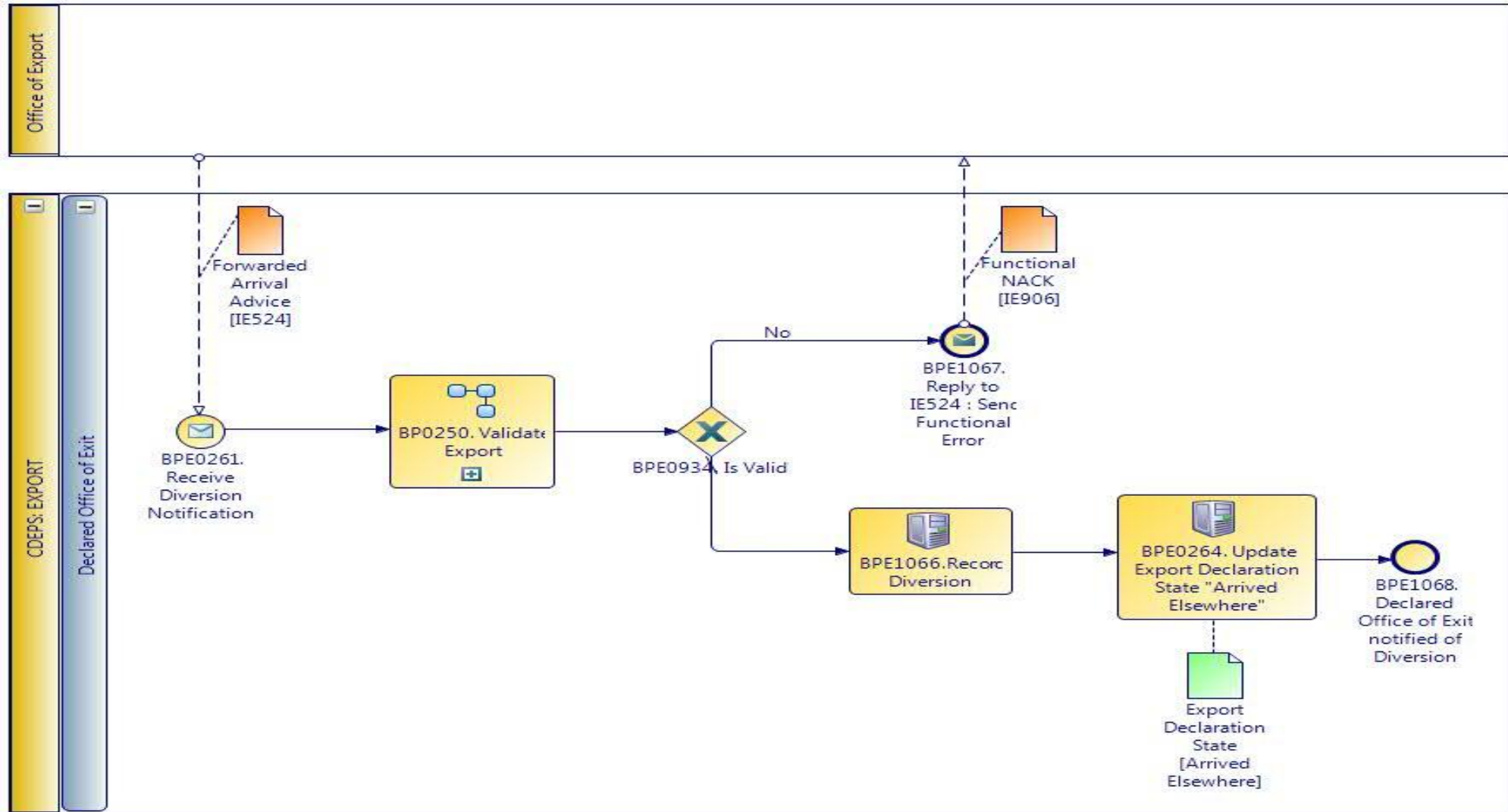

CARM Customs Declaration and Excise Documents Processing system (CDEPS)	REF: CDEPS_EXPORT_BPS
Business Process Specifications for EXPORT System	VER:410

2.3.6.1 Activities

The table below defines the 'Activities' of the 'BP0140. Process Arrival Advice @ Declared Office of Exit' process.

Element Name	Description	Special Type
BPE0264. Update Export Declaration State "Arrived Elsewhere"	Validation shows no errors, diversion is recorded at the Declared Office of Exit	Service Task
BPE1066. Record Diversion	The diversion notification is validated and the diversion is recorded into the system.	Service Task

2.3.6.2 Event(s)

The table below defines the 'Event(s)' of the 'BP0140. Process Arrival Advice @ Declared Office of Exit' process.

Element Name	Description	Special Type
BPE0261. Receive Diversion Notification	Declared Office of Exit receives the Diversion Notification from the Office of Export	Start
BPE1067. Reply to IE524 : Send Functional Error	The Office of Exit rejects the Diversion Notification and notifies the Office of Export via an electronic message.	End
BPE1068. Declared Office of Exit notified of Diversion	The Diversion Notification is invalid and the Office of Export is notified of the rejection	End

2.3.6.3 Gateway(s)

The table below defines the 'Gateway(s)' of the 'BP0140. Process Arrival Advice @ Declared Office of Exit' process.

Element Name	Description	Special Type
BPE0934. Is Valid?	A decision point in the process to navigate the flow based on the message validation result.	Decision
↳ Business Rule 638	<i>Import declaration type 'X' cannot be cancelled</i>	
↳ Business Rule 646	<i>Guarantees during the registration of Import declaration type 'X'</i>	
↳ Business Rule 80	<i>Valid Message</i>	

CARM Customs Declaration and Excise Documents Processing system (CDEPS)	REF: CDEPS_EXPORT_BPS
Business Process Specifications for EXPORT System	VER:410

2.3.7.BP0005. Validate

Business Process Description

The following table provides general information about the 'BP0005. Validate' process. The Business Process Diagram and the description of various business process elements are specified in the following paragraphs.

Description	Reusable subprocess that performs the message validation tasks
Precondition(s)	None
Trigger	The process is triggered when an electronic message is received for validation.
Postcondition(s)	

Business Process Diagram

The Business Process Diagram of 'BP0005. Validate' is shown below in BPMN notation. The definition of a process that might be used as sub-process by the 'BP0005. Validate' can be found in this document. Finally, Annex A of CDEPS-BPS-EXPORT provides some explanatory information about the used notation.

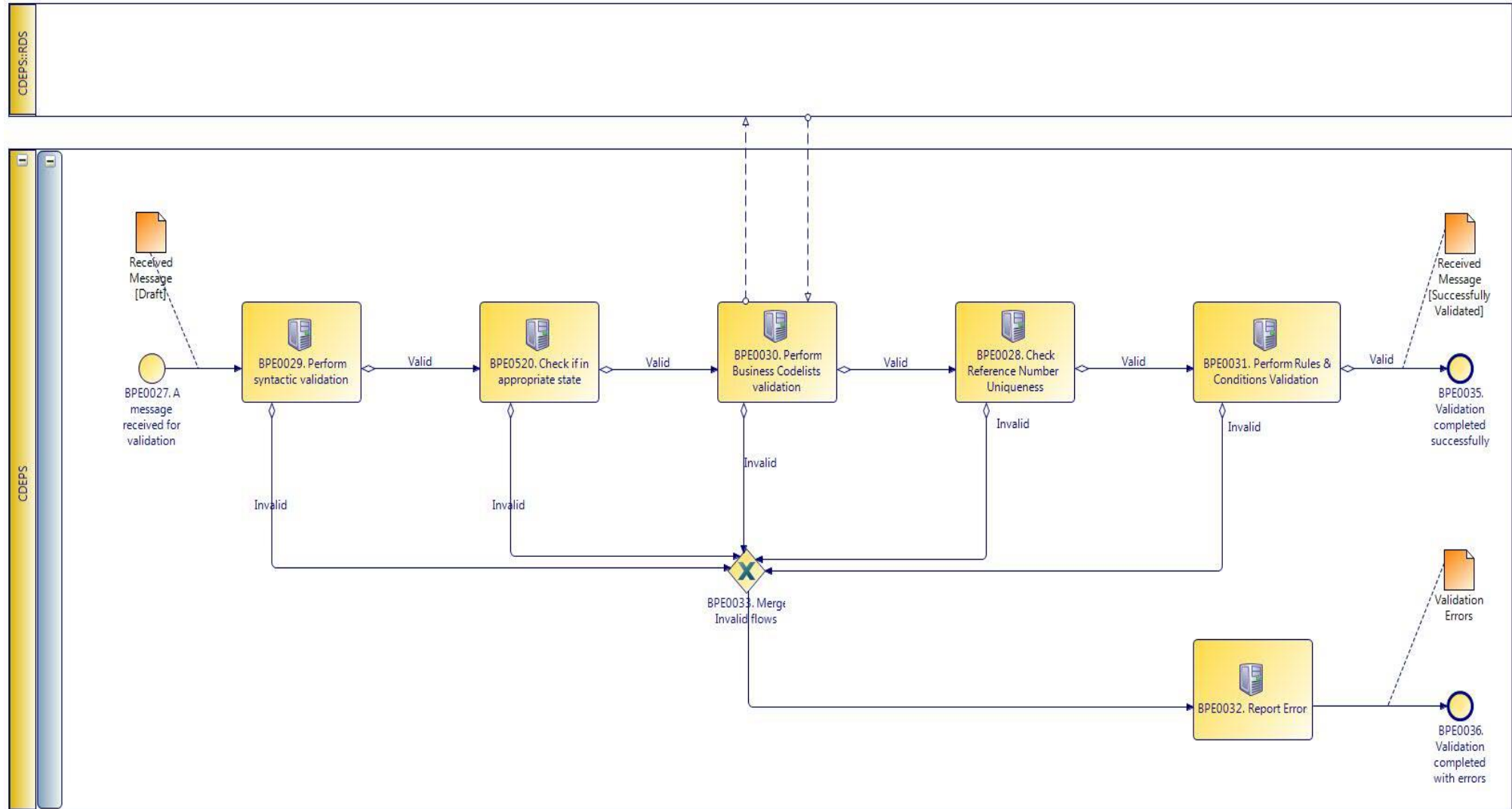

CARM Customs Declaration and Excise Documents Processing system (CDEPS)	REF: CDEPS_EXPORT_BPS
Business Process Specifications for EXPORT System	VER:410

2.3.7.1 Activities

The table below defines the 'Activities' of the 'BP0005. Validate' process.

Element Name	Description	Special Type
BPE0028. Check Reference Number Uniqueness	Check whether message reference numbers are unique in the system.	Service Task
↳ Business Rule 1	<i>Check Message Identification uniqueness</i>	
↳ Business Rule 74	<i>Check Local Reference Number (LRN) uniqueness</i>	
↳ Business Rule 75	<i>Check Movement Reference Number (MRN)uniqueness</i>	
↳ Business Rule 79	<i>Check Manifest reference number uniqueness</i>	
BPE0029. Perform syntactic validation	Check messages against the XSDs.	Service Task
↳ Business Rule 47	<i>Syntactic validation</i>	
BPE0030. Perform Business Codelists validation	Check the message business codelists.	Service Task
↳ Business Rule 50	<i>Business codelist validation against CDEPS:RDS</i>	
BPE0031. Perform Rules & Conditions Validation	Check the rules and conditions of the respective message.	Service Task
BPE0032. Report Errors	Report the identified errors from the validation process. The process terminates.	Service Task
BPE0520. Check if in appropriate state	Check whether the process for the particular entity (e.g. declaration/ application/ document) is on the appropriate state to process the received message. This check shall be performed based on the pertinent State Model of the system.	Service Task
↳ Business Rule 421	<i>Supplementary Declaration validation at Export</i>	
↳ Business Rule 448	<i>Check appropriate state for Export Declaration Amendment</i>	

CARM Customs Declaration and Excise Documents Processing system (CDEPS)	REF: CDEPS_EXPORT_BPS
Business Process Specifications for EXPORT System	VER:410

- ↳ **Business Rule** 449 *Check appropriate state Declaration Goods Presentation*
- ↳ **Business Rule** 468 *Guarantee Amendment*
- ↳ **Business Rule** 492 *Exit control results received at Export*
- ↳ **Business Rule** 493 *Export Declaration request at Export*

2.3.7.2 Event(s)

The table below defines the 'Event(s)' of the 'BP0005. Validate' process.

Element Name	Description	Special Type
BPE0027. A message or event notification from GUI is received for validation	Message input in the validation process.	Start
BPE0035. Validation completed successfully	The validation is completed successfully with no errors reported. The process terminates.	End
BPE0036. Validation completed with errors	The validation completed with errors. The process terminates.	End

2.3.7.3 Gateway(s)

The table below defines the 'Gateway(s)' of the 'BP0005. Validate' process.

Element Name	Description	Special Type
BPE0033. Merge Invalid Flows	Merge into exclusive event based gateway the invalid flows from all validation tasks.	Merge

CARM Customs Declaration and Excise Documents Processing system (CDEPS)	REF: CDEPS_EXPORT_BPS
Business Process Specifications for EXPORT System	VER:410

2.4. Process Group: Export Declaration arrival at Export

2.4.1.BP0139. Process Arrival @ Office of Export

Business Process Description

The following table provides general information about the 'BP0139. Process Arrival @ Office of Export' process. The Business Process Diagram and the description of various business process elements are specified in the following paragraphs.

Description	A high level process describing the actions performed by the system in order to process the arrival at the Office of Export.
Precondition(s)	- None - Goods Released for Export
Trigger	The process is triggered by the declaration request received from the Actual Office of Exit
Postcondition(s)	None

Business Process Diagram

The Business Process Diagram of 'BP0139. Process Arrival @ Office of Export' is shown below in BPMN notation. The definition of a process that might be used as sub-process by the 'BP0139. Process Arrival @ Office of Export' can be found in this document. Finally, Annex A of CDEPS-BPS-EXPORT provides some explanatory information about the used notation.

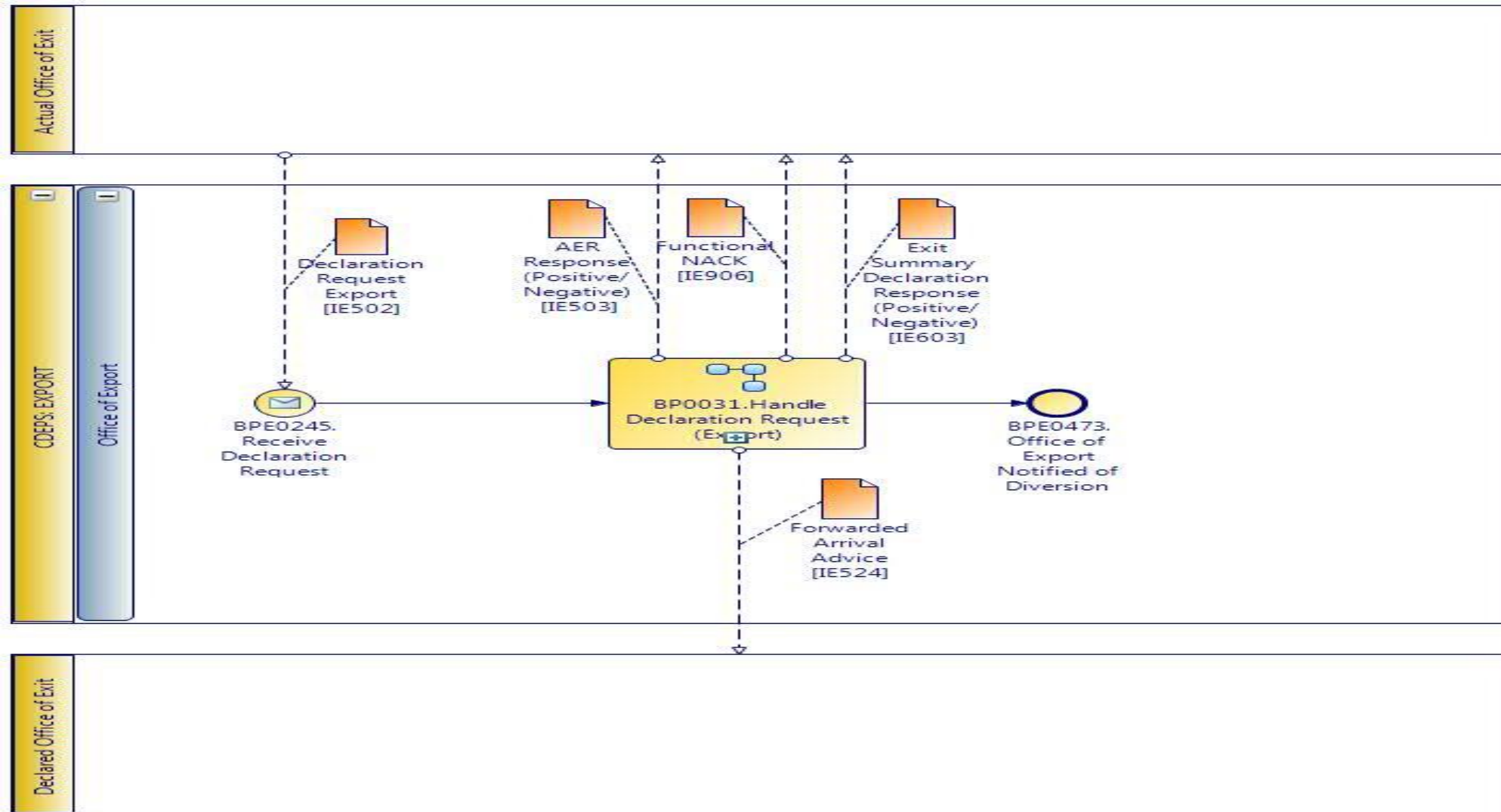

CARM Customs Declaration and Excise Documents Processing system (CDEPS)	REF: CDEPS_EXPORT_BPS
Business Process Specifications for EXPORT System	VER:410

2.4.1.1 Event(s)

The table below defines the 'Event(s)' of the 'BP0139. Process Arrival @ Office of Export' process.

Element Name	Description	Special Type
BPE0245. Receive Declaration Request	Receive an export declaration request from the Office of Exit	Start
BPE0473. Office of Export Notified of Diversion	The Office of Export Notified of Diversion	End

CARM Customs Declaration and Excise Documents Processing system (CDEPS)	REF: CDEPS_EXPORT_BPS
Business Process Specifications for EXPORT System	VER:410

2.4.2.BP0031. Handle Declaration Request (Export)

Business Process Description

The following table provides general information about the 'BP0031. Handle Declaration Request (Export)' process. The Business Process Diagram and the description of various business process elements are specified in the following paragraphs.

Description	This process is used for export and exit summary declarations to request and retrieve data (if available) on an EXPORT Operation for which data is not available in the Member State of the Actual Office of Exit (international diversion or other exceptional cases).
Precondition(s)	Declaration request is received
Trigger	The process is triggered by the declaration request (IE502) from the Office of Exit
Postcondition(s)	None

Business Process Diagram

The Business Process Diagram of 'BP0031. Handle Declaration Request (Export)' is shown below in BPMN notation. The definition of a process that might be used as sub-process by the 'BP0031. Handle Declaration Request (Export)' can be found in this document. Finally, Annex A of CDEPS-BPS-EXPORT provides some explanatory information about the used notation.

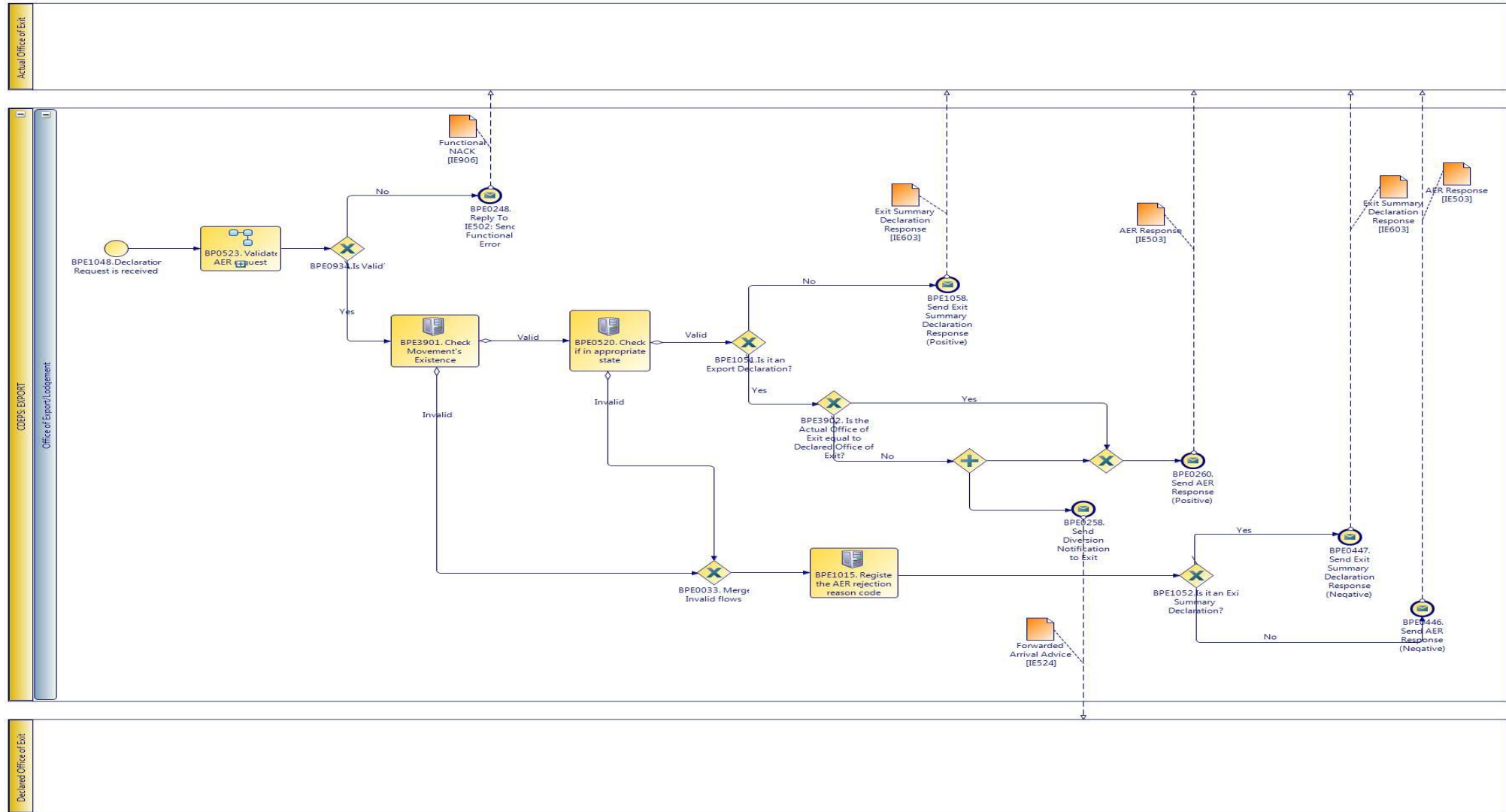

CARM Customs Declaration and Excise Documents Processing system (CDEPS)	REF: CDEPS_EXPORT_BPS
Business Process Specifications for EXPORT System	VER:410

2.4.2.1 Activities

The table below defines the 'Activities' of the 'BP0031. Handle Declaration Request (Export)' process.

Element Name	Description	Special Type
BPE0520. Check if in appropriate state	Check whether the process for the particular entity (e.g. declaration/ application/ document) is on the appropriate state to process the received message. This check shall be performed based on the pertinent State Model of the system.	Service Task
↳ Business Rule 421	<i>Supplementary Declaration validation at Export</i>	
↳ Business Rule 448	<i>Check appropriate state for Export Declaration Amendment</i>	
↳ Business Rule 449	<i>Check appropriate state Declaration Goods Presentation</i>	
↳ Business Rule 468	<i>Guarantee Amendment</i>	
↳ Business Rule 492	<i>Exit control results received at Export</i>	
↳ Business Rule 493	<i>Export Declaration request at Export</i>	
BPE1015. Register the Declaration Request rejection reason code	The system registers the Declaration Request rejection reason code based on the results of the checks performed previously	Service Task
BPE1051. Is it an Export Declaration?	A decision point on the process to navigate the flow based on the type of the declaration (Export or Exit Summary).	
BPE3901. Check Movement's Existence	The system checks whether the movement exists	Service Task

2.4.2.2 Event(s)

The table below defines the 'Event(s)' of the 'BP0031. Handle Declaration Request (Export)' process.

Element Name	Description	Special Type
BPE0248. Reply To IE502: Send Functional Error	The system sends a Functional Error message back to the Office of Exit as a reply to the invalid Declaration Request received.	End
BPE0258. Send Diversion Notification to Exit	Declaration response is positive, notify diversion to the declared OoExt	End

CARM Customs Declaration and Excise Documents Processing system (CDEPS)	REF: CDEPS_EXPORT_BPS
Business Process Specifications for EXPORT System	VER:410

BPE0260. Send AER Response (Positive)	A positive AER response is sent to the Office of Exit in case the MRN is known and the export declaration is in the appropriate state.	End
BPE0446. Send AER Response (Negative)	A negative AER response is sent to the Office of Exit in case either the MRN is unknown or the the MRN is known but the export declaration is not in an appropriate state.	End
BPE0447. Send Exit Summary Declaration Response (Negative)	A negative Exit Summary Declaration response is sent to the Office of Exit in case either the MRN is unknown or the the MRN is known but the summary declaration is not in an appropriate state.	End
BPE1048. Declaration Request is received	A Declaration Request from Office of Exit is received	Start
BPE1058. Send Exit Summary Declaration Response (Positive)	A positive Exit Summary Declaration response is sent to the Office of Exit in case the MRN is known and the summary declaration is in the appropriate state.	End

2.4.2.3 Gateway(s)

The table below defines the 'Gateway(s)' of the 'BP0031. Handle Declaration Request (Export)' process.

Element Name	Description	Special Type
BPE0033. Merge Invalid Flows	Merge into exclusive event based gateway the invalid flows from all validation tasks.	Merge
BPE0246. Is Declaration Request valid?	IF BP5.result = "Validation completed successfully" THEN TRUE ELSE FALSE	Decision
BPE0934. Is Valid?	A decision point in the process to navigate the flow based on the message validation result.	Decision
↳ Business Rule	638 <i>Import declaration type 'X' cannot be cancelled</i>	
↳ Business Rule	646 <i>Guarantees during the registration of Import declaration type 'X'</i>	
↳ Business Rule	80 <i>Valid Message</i>	
BPE1052. Is it an Exit Summary Declaration?	A decision point on the process to navigate the flow based on the type of the declaration (Export or Exit Summary).	Decision

CARM Customs Declaration and Excise Documents Processing system (CDEPS)	REF: CDEPS_EXPORT_BPS
Business Process Specifications for EXPORT System	VER:410

BPE3902. Is the Actual Office of Exit equal to Declared Office of Exit? A decision point in the process to navigate the flow based on whether the IActual Office Decision of Exit is equal to Declared Office of Exit

CARM Customs Declaration and Excise Documents Processing system (CDEPS)	REF: CDEPS_EXPORT_BPS
Business Process Specifications for EXPORT System	VER:410

2.4.3.BP0523. Validate Declaration Request

Business Process Description

The following table provides general information about the 'BP0523. Validate Declaration Request' process. The Business Process Diagram and the description of various business process elements are specified in the following paragraphs.

Description	Reusable subprocess that describes the tasks performed by the system in order to validate the Declaration request received from the Office of Exit
Precondition(s)	None
Trigger	AER request received for validation
Postcondition(s)	- Validation completed successfully - Validation completed with errors

Business Process Diagram

The Business Process Diagram of 'BP0523. Validate Declaration Request' is shown below in BPMN notation. The definition of a process that might be used as sub-process by the 'BP0523. Validate Declaration Request' can be found in this document. Finally, Annex A of CDEPS-BPS-EXPORT provides some explanatory information about the used notation.

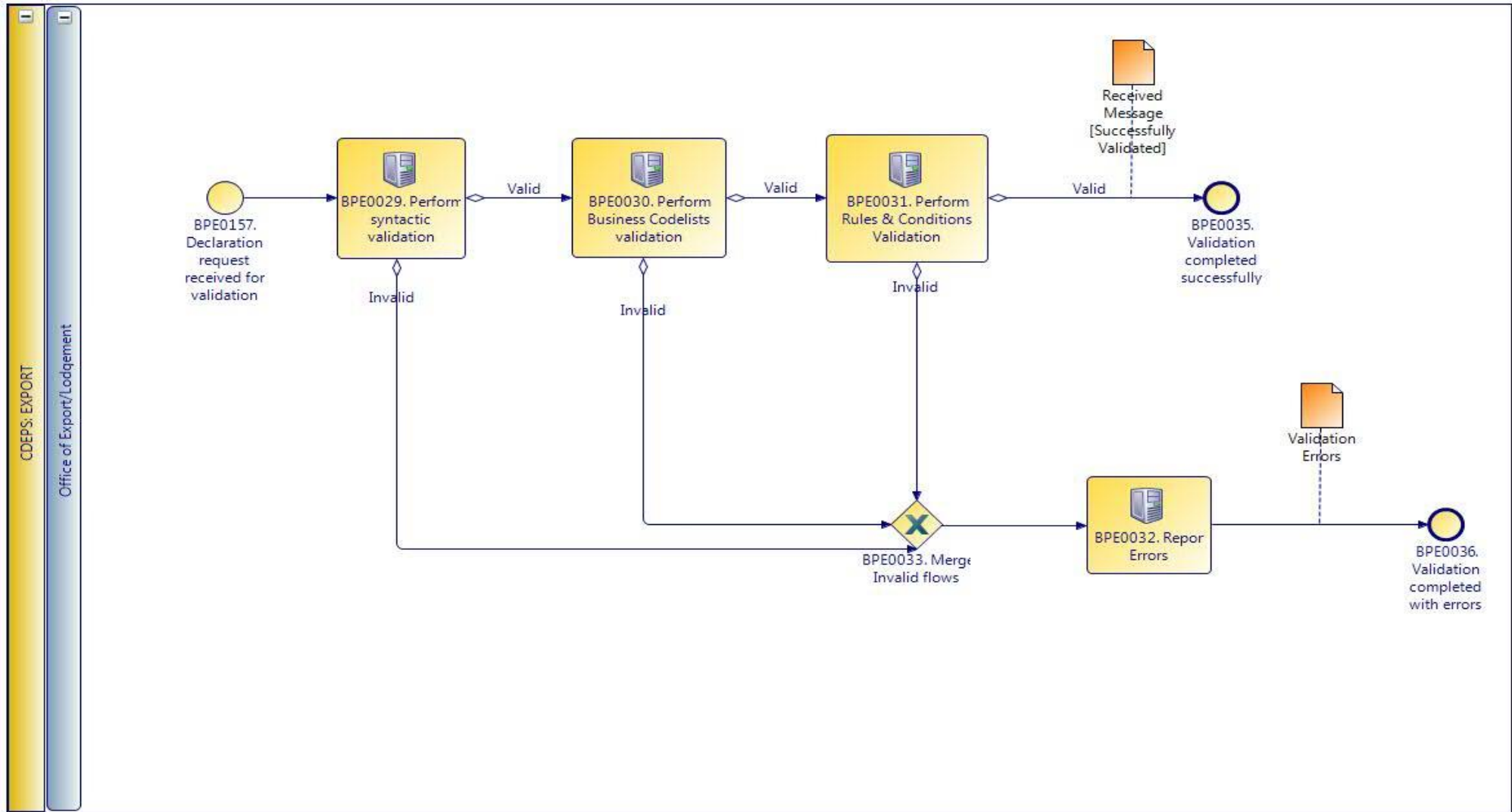

CARM Customs Declaration and Excise Documents Processing system (CDEPS)	REF: CDEPS_EXPORT_BPS
Business Process Specifications for EXPORT System	VER:410

2.4.3.1 Activities

The table below defines the 'Activities' of the 'BP0523. Validate Declaration Request' process.

Element Name	Description	Special Type
BPE0029. Perform syntactic validation	Check messages against the XSDs.	Service Task
↳ Business Rule 47	<i>Syntactic validation</i>	
BPE0030. Perform Business Codelists validation	Check the message business codelists.	Service Task
↳ Business Rule 50	<i>Business codelist validation against CDEPS:RDS</i>	
BPE0031. Perform Rules & Conditions Validation	Check the rules and conditions of the respective message.	Service Task
BPE0032. Report Errors	Report the identified errors from the validation process. The process terminates.	Service Task

2.4.3.2 Event(s)

The table below defines the 'Event(s)' of the 'BP0523. Validate Declaration Request' process.

Element Name	Description	Special Type
BPE0035. Validation completed successfully	The validation is completed successfully with no errors reported. The process terminates.	End
BPE0036. Validation completed with errors	The validation completed with errors. The process terminates.	End
BPE0157. Declaration request received for validation	Declaration request received for validation	Start

CARM Customs Declaration and Excise Documents Processing system (CDEPS)	REF: CDEPS_EXPORT_BPS
Business Process Specifications for EXPORT System	VER:410

2.4.3.3 Gateway(s)

The table below defines the 'Gateway(s)' of the 'BP0523. Validate Declaration Request' process.

Element Name	Description	Special Type
BPE0033. Merge Invalid Flows	Merge into exclusive event based gateway the invalid flows from all validation tasks.	Merge

CARM Customs Declaration and Excise Documents Processing system (CDEPS)	REF: CDEPS_EXPORT_BPS
Business Process Specifications for EXPORT System	VER:410

2.4.4.BP0250. Validate Export

Business Process Description

The following table provides general information about the 'BP0250. Validate Export' process. The Business Process Diagram and the description of various business process elements are specified in the following paragraphs.

Description	Reusable subprocess that performs the message validation tasks for Export Regime.
Precondition(s)	None
Trigger	The process is triggered when an electronic message is received for validation.
Postcondition(s)	The validation is either completed successfully or with errors reported

Business Process Diagram

The Business Process Diagram of 'BP0250. Validate Export' is shown below in BPMN notation. The definition of a process that might be used as sub-process by the 'BP0250. Validate Export' can be found in this document. Finally, Annex A of CDEPS-BPS-EXPORT provides some explanatory information about the used notation.

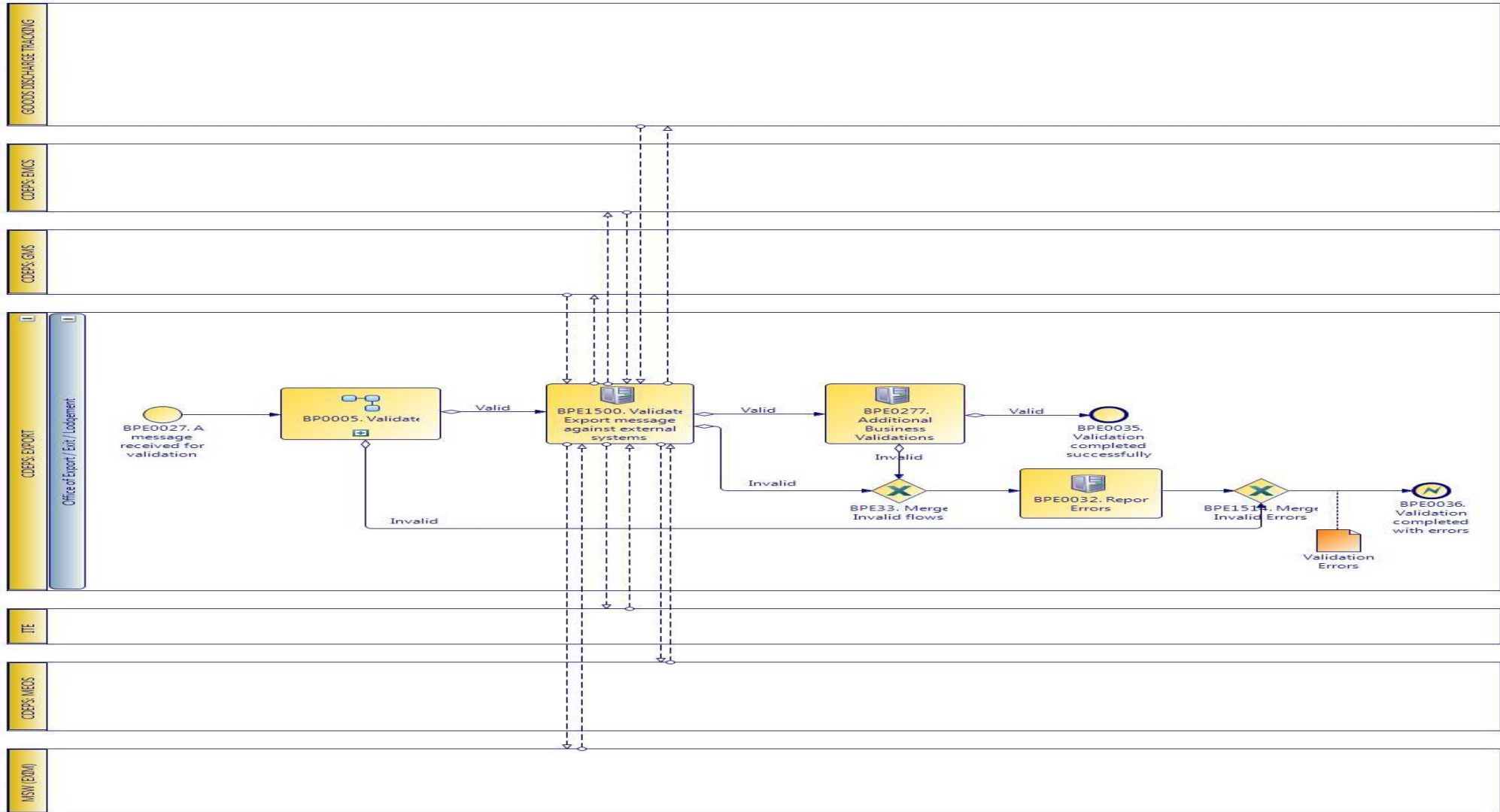

CARM Customs Declaration and Excise Documents Processing system (CDEPS)	REF: CDEPS_EXPORT_BPS
Business Process Specifications for EXPORT System	VER:410

2.4.4.1 Activities

The table below defines the 'Activities' of the 'BP0250. Validate Export' process.

Element Name	Description	Special Type
BPE0032. Report Errors	Report the identified errors from the validation process. The process terminates.	Service Task
BPE0277. Additional Business Validations for Export	The system performs any additional business validations specific to Export System.	Service Task
↳ Business Rule 19	Trader amending data same as Person lodging the declaration	
↳ Business Rule 21	Reject ENS/EXS amendment if ENS/EXS is not in appropriate state	
↳ Business Rule 245	Validate Personal ID	
↳ Business Rule 39	Cancellation Constraint	
↳ Business Rule 520	Import/ Export allowed guarantee types	
↳ Business Rule 70	EXS exists at the Office of Exit	
↳ Business Rule 71	Manifest number in IE547 and IE590	
BPE1500. Validate Export message against external systems	The system performs message validations against external systems.	Service Task
↳ Business Rule 101	Validate Economic Operator against MEOS	
↳ Business Rule 422	Validation of NCTS notifications	
↳ Business Rule 425	Goods Discharge required	
↳ Business Rule 439	Validate against GMS for integrity check	
↳ Business Rule 440	Validate Economic Operator's TIN against MEOS	
↳ Business Rule 494	Orchestrate validation of Export message against external systems	
↳ Business Rule 508	Validation of Export licenses with EXIM	

CARM Customs Declaration and Excise Documents Processing system (CDEPS)	REF: CDEPS_EXPORT_BPS
Business Process Specifications for EXPORT System	VER:410
↳ Business Rule 509	Check Export authorizations with MEOS
↳ Business Rule 51	Validate declared Combined Nomenclature in Declaration against ITE.
↳ Business Rule 510	Check Export authorizations for representation with MEOS
↳ Business Rule 511	Check Evidence of Power of Attorney with MEOS
↳ Business Rule 521	Validate Export declaration against ITE (duty calculation).
↳ Business Rule 522	Validate Export declaration data against Goods Discharge Tracking system
↳ Business Rule 527	Validate Export Declaration data against Excise system

2.4.4.2 Event(s)

The table below defines the 'Event(s)' of the 'BP0250. Validate Export' process.

Element Name	Description	Special Type
BPE0027. A message or event notification from GUI is received for validation	Message input in the validation process.	Start
BPE0035. Validation completed successfully	The validation is completed successfully with no errors reported. The process terminates.	End
BPE0036. Validation completed with errors	The validation completed with errors. The process terminates.	End

2.4.4.3 Gateway(s)

The table below defines the 'Gateway(s)' of the 'BP0250. Validate Export' process.

Element Name	Description	Special Type
BPE1514. Merge Invalid Errors	Combines exclusively either the negative outcome of generic validate process (BP0005. Validate) which reports errors or the errors from the extra checks for the specific system.	Merge

CARM Customs Declaration and Excise Documents Processing system (CDEPS)	REF: CDEPS_EXPORT_BPS
Business Process Specifications for EXPORT System	VER:410

2.4.5.BP0005. Validate

Business Process Description

The following table provides general information about the 'BP0005. Validate' process. The Business Process Diagram and the description of various business process elements are specified in the following paragraphs.

Description	Reusable subprocess that performs the message validation tasks
Precondition(s)	None
Trigger	The process is triggered when an electronic message is received for validation.
Postcondition(s)	

Business Process Diagram

The Business Process Diagram of 'BP0005. Validate' is shown below in BPMN notation. The definition of a process that might be used as sub-process by the 'BP0005. Validate' can be found in this document. Finally, Annex A of CDEPS-BPS-EXPORT provides some explanatory information about the used notation.

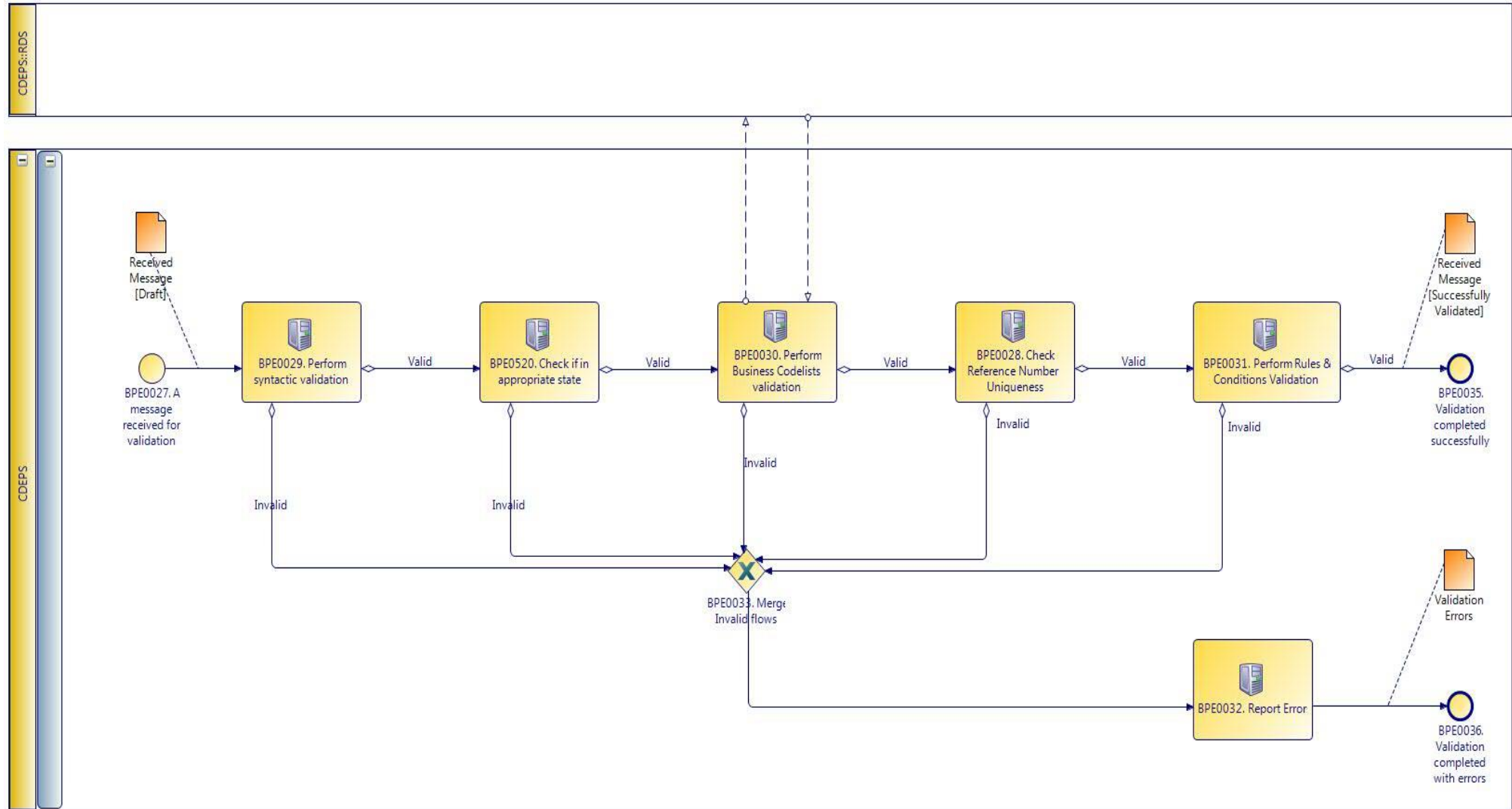

CARM Customs Declaration and Excise Documents Processing system (CDEPS)	REF: CDEPS_EXPORT_BPS
Business Process Specifications for EXPORT System	VER:410

2.4.5.1 Activities

The table below defines the 'Activities' of the 'BP0005. Validate' process.

Element Name	Description	Special Type
BPE0028. Check Reference Number Uniqueness	Check whether message reference numbers are unique in the system.	Service Task
↳ Business Rule 1	<i>Check Message Identification uniqueness</i>	
↳ Business Rule 74	<i>Check Local Reference Number (LRN) uniqueness</i>	
↳ Business Rule 75	<i>Check Movement Reference Number (MRN)uniqueness</i>	
↳ Business Rule 79	<i>Check Manifest reference number uniqueness</i>	
BPE0029. Perform syntactic validation	Check messages against the XSDs.	Service Task
↳ Business Rule 47	<i>Syntactic validation</i>	
BPE0030. Perform Business Codelists validation	Check the message business codelists.	Service Task
↳ Business Rule 50	<i>Business codelist validation against CDEPS:RDS</i>	
BPE0031. Perform Rules & Conditions Validation	Check the rules and conditions of the respective message.	Service Task
BPE0032. Report Errors	Report the identified errors from the validation process. The process terminates.	Service Task
BPE0520. Check if in appropriate state	Check whether the process for the particular entity (e.g. declaration/ application/ document) is on the appropriate state to process the received message. This check shall be performed based on the pertinent State Model of the system.	Service Task
↳ Business Rule 421	<i>Supplementary Declaration validation at Export</i>	
↳ Business Rule 448	<i>Check appropriate state for Export Declaration Amendment</i>	

CARM Customs Declaration and Excise Documents Processing system (CDEPS)	REF: CDEPS_EXPORT_BPS
Business Process Specifications for EXPORT System	VER:410

- ↳ **Business Rule** 449 *Check appropriate state Declaration Goods Presentation*
- ↳ **Business Rule** 468 *Guarantee Amendment*
- ↳ **Business Rule** 492 *Exit control results received at Export*
- ↳ **Business Rule** 493 *Export Declaration request at Export*

2.4.5.2 Event(s)

The table below defines the 'Event(s)' of the 'BP0005. Validate' process.

Element Name	Description	Special Type
BPE0027. A message or event notification from GUI is received for validation	Message input in the validation process.	Start
BPE0035. Validation completed successfully	The validation is completed successfully with no errors reported. The process terminates.	End
BPE0036. Validation completed with errors	The validation completed with errors. The process terminates.	End

2.4.5.3 Gateway(s)

The table below defines the 'Gateway(s)' of the 'BP0005. Validate' process.

Element Name	Description	Special Type
BPE0033. Merge Invalid Flows	Merge into exclusive event based gateway the invalid flows from all validation tasks.	Merge

CARM Customs Declaration and Excise Documents Processing system (CDEPS)	REF: CDEPS_EXPORT_BPS
Business Process Specifications for EXPORT System	VER:410

2.5. Process Group: Export operation exit at Exit

2.5.1.BP0143. Process Exit @ Actual Office of Exit

Business Process Description

The following table provides general information about the 'BP0143. Process Exit @ Actual Office of Exit' process. The Business Process Diagram and the description of various business process elements are specified in the following paragraphs.

Description	A high level process describing the actions performed by the system in order to process the exit of the movement at the Actual Office of Exit
Precondition(s)	Goods are released for Exit
Trigger	The processed is triggered by the manifest presentation either received electronically by the Trader or captured manually by the Customs Officer
Postcondition(s)	None

Business Process Diagram

The Business Process Diagram of 'BP0143. Process Exit @ Actual Office of Exit' is shown below in BPMN notation. The definition of a process that might be used as sub-process by the 'BP0143. Process Exit @ Actual Office of Exit' can be found in this document. Finally, Annex A of CDEPS-BPS-EXPORT provides some explanatory information about the used notation.

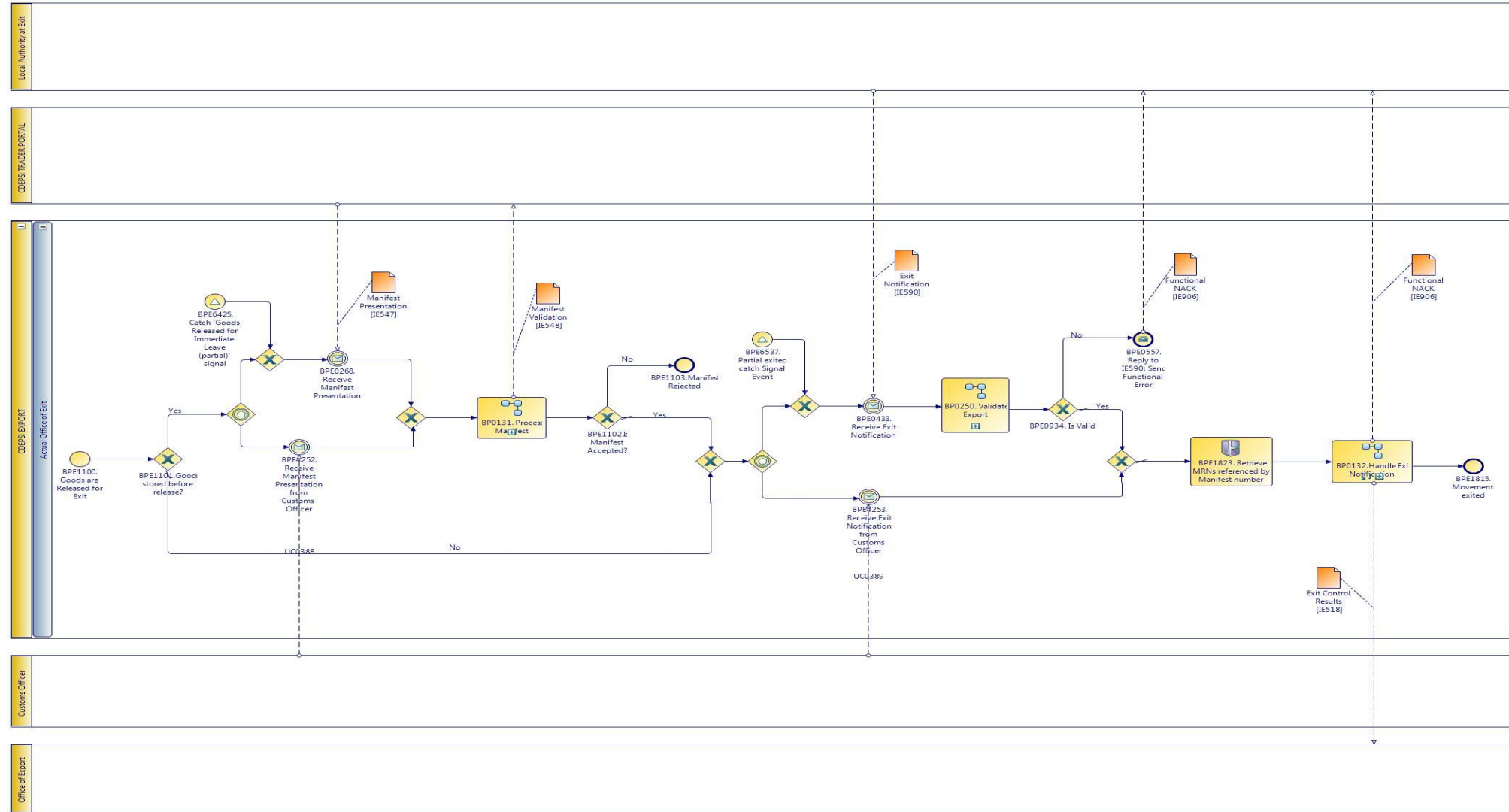

CARM Customs Declaration and Excise Documents Processing system (CDEPS)	REF: CDEPS_EXPORT_BPS
Business Process Specifications for EXPORT System	VER:410

2.5.1.1 Activities

The table below defines the 'Activities' of the 'BP0143. Process Exit @ Actual Office of Exit' process.

Element Name	Description	Special Type
BPE1823. Retrieve MRNs referenced by Manifest number	The system retrieves and processes the MRNs referenced by the specific manifest number.	Service Task

2.5.1.2 Event(s)

The table below defines the 'Event(s)' of the 'BP0143. Process Exit @ Actual Office of Exit' process.

Element Name	Description	Special Type
BPE0268. Receive Manifest Presentation	Trader at Exit presents manifest	Intermediate
BPE0433. Receive Exit Notification	The system in the Actual Office of Exit receives an Exit Notification (IE590) by the Local Authorities in charge of verifying the actual exit.	Start
BPE0557. Reply to IE590: Send Functional Error	Send functional error in case of rejection	End
BPE1100. Goods are Released for Exit	The goods have been released for Exit and their processing at the Actual Office of Exit begins.	Start
BPE1103. Manifest Rejected	The Manifest has been rejected upon its invalidation. The process terminates.	End
BPE1815. Movement exited	The movement is exited and the process terminates.	End
BPE4252. Receive Manifest Presentation from Customs Officer	Customs Officer at Exit presents Manifest	Intermediate
BPE6425. Catch 'Goods Released for Immediate Leave (partial)' signal	Catch 'Goods Released for Immediate Leave (partial)' signal	Start

CARM Customs Declaration and Excise Documents Processing system (CDEPS)	REF: CDEPS_EXPORT_BPS
Business Process Specifications for EXPORT System	VER:410

BPE6537. Partial exited catch Signal Event A start event that catches the partial exited signal event Start

2.5.1.3 Gateway(s)

The table below defines the 'Gateway(s)' of the 'BP0143. Process Exit @ Actual Office of Exit' process.

Element Name	Description	Special Type
BPE0934. Is Valid?	A decision point in the process to navigate the flow based on the message validation result.	Decision
↳ Business Rule 638	<i>Import declaration type 'X' cannot be cancelled</i>	
↳ Business Rule 646	<i>Guarantees during the registration of Import declaration type 'X'</i>	
↳ Business Rule 80	<i>Valid Message</i>	
BPE1101. Goods stored before release?	A decision point in the process to navigate the flow based on whether the goods have been stored before their release.	Decision
BPE1102. Is Manifest Accepted?	A decision point in the process to navigate the flow based on whether the received manifest has been accepted.	Decision

CARM Customs Declaration and Excise Documents Processing system (CDEPS)	REF: CDEPS_EXPORT_BPS
Business Process Specifications for EXPORT System	VER:410

2.5.2.BP0131. Process Manifest

Business Process Description

The following table provides general information about the 'BP0131. Process Manifest' process. The Business Process Diagram and the description of various business process elements are specified in the following paragraphs.

Description	The process describes the actions performed by the system in order to process the manifest received
Precondition(s)	Manifest Presentation is Received
Trigger	The process is triggered when a manifest presentation is received
Postcondition(s)	<ul style="list-style-type: none"> - None - Goods Released for Immediate Leave (partial) - Goods Released for Immediate Leave - Partially Exited

Business Process Diagram

The Business Process Diagram of 'BP0131. Process Manifest' is shown below in BPMN notation. The definition of a process that might be used as sub-process by the 'BP0131. Process Manifest' can be found in this document. Finally, Annex A of CDEPS-BPS-EXPORT provides some explanatory information about the used notation.

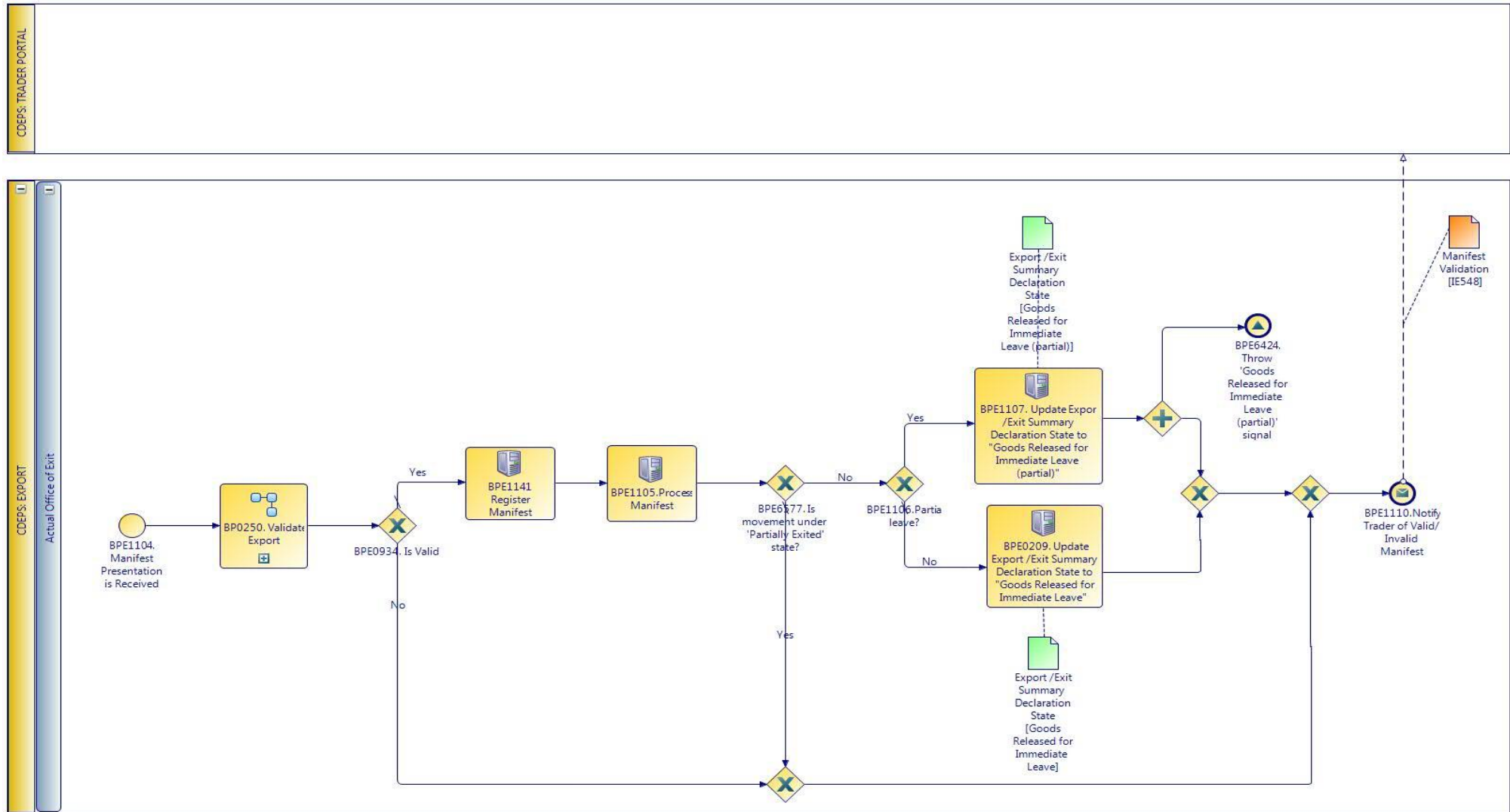

CARM Customs Declaration and Excise Documents Processing system (CDEPS)	REF: CDEPS_EXPORT_BPS
Business Process Specifications for EXPORT System	VER:410

2.5.2.1 Activities

The table below defines the 'Activities' of the 'BP0131. Process Manifest' process.

Element Name	Description	Special Type
BPE0209. Update Export /Exit Summary Declaration State to "Goods Released for Immediate Leave"	The system updates the Export /Exit Summary Declaration State to "Goods released for immediate leave".	
BPE1105. Process Manifest	The system handles and processes the manifest presentation received by the Trader upon its validation.	Service Task
↳ Business Rule	416 <i>Manifest Number structure</i>	
BPE1107. Update Export /Exit Summary Declaration State to "Goods Released for Immediate Leave (partial)"	The system updates the Export /Exit Summary Declaration State to "Goods Released for Immediate Leave" (partial) upon the decision of goods partial leave.	Service Task
BPE1141. Register Manifest	The system registers the manifest presented at the Office of Exit	Service Task

2.5.2.2 Event(s)

The table below defines the 'Event(s)' of the 'BP0131. Process Manifest' process.

Element Name	Description	Special Type
BPE1104. Manifest Presentation is Received	In case the goods are stored before release, the Manifest Presentation sent by the Trader is received.	Start
BPE1110. Notify Trader of Valid/Invalid Manifest	The Trader is being notified that the manifest has been either validated or invalidated	End

CARM Customs Declaration and Excise Documents Processing system (CDEPS)	REF: CDEPS_EXPORT_BPS
Business Process Specifications for EXPORT System	VER:410

BPE6424. Throw 'Goods Released for Immediate Leave (partial)' signal End

2.5.2.3 Gateway(s)

The table below defines the 'Gateway(s)' of the 'BP0131. Process Manifest' process.

Element Name	Description	Special Type
BPE0934. Is Valid?	A decision point in the process to navigate the flow based on the message validation result.	Decision
↳ Business Rule 638	<i>Import declaration type 'X' cannot be cancelled</i>	
↳ Business Rule 646	<i>Guarantees during the registration of Import declaration type 'X'</i>	
↳ Business Rule 80	<i>Valid Message</i>	
BPE1106. Partial leave?	A decision point in the process to navigate the flow based on whether the goods have been released for partial leave or not.	Decision
BPE6577. Is movement under 'Partially Exited' state?	Is movement under 'Partially Exited' state?	Decision

CARM Customs Declaration and Excise Documents Processing system (CDEPS)	REF: CDEPS_EXPORT_BPS
Business Process Specifications for EXPORT System	VER:410

2.5.3.BP0250. Validate Export

Business Process Description

The following table provides general information about the 'BP0250. Validate Export' process. The Business Process Diagram and the description of various business process elements are specified in the following paragraphs.

Description	Reusable subprocess that performs the message validation tasks for Export Regime.
Precondition(s)	None
Trigger	The process is triggered when an electronic message is received for validation.
Postcondition(s)	The validation is either completed successfully or with errors reported

Business Process Diagram

The Business Process Diagram of 'BP0250. Validate Export' is shown below in BPMN notation. The definition of a process that might be used as sub-process by the 'BP0250. Validate Export' can be found in this document. Finally, Annex A of CDEPS-BPS-EXPORT provides some explanatory information about the used notation.

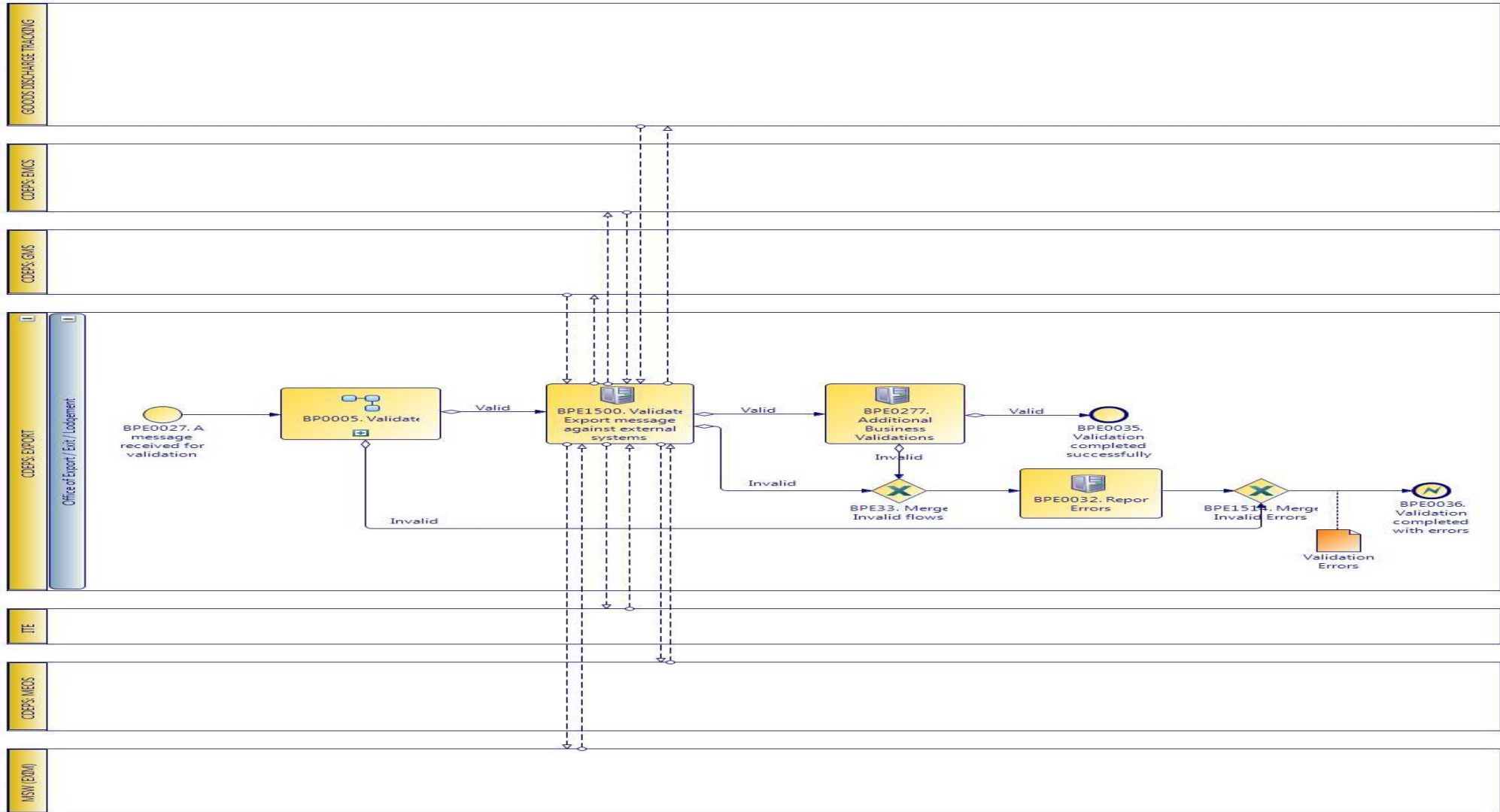

CARM Customs Declaration and Excise Documents Processing system (CDEPS)	REF: CDEPS_EXPORT_BPS
Business Process Specifications for EXPORT System	VER:410

2.5.3.1 Activities

The table below defines the 'Activities' of the 'BP0250. Validate Export' process.

Element Name	Description	Special Type
BPE0032. Report Errors	Report the identified errors from the validation process. The process terminates.	Service Task
BPE0277. Additional Business Validations for Export	The system performs any additional business validations specific to Export System.	Service Task
↳ Business Rule 19	Trader amending data same as Person lodging the declaration	
↳ Business Rule 21	Reject ENS/EXS amendment if ENS/EXS is not in appropriate state	
↳ Business Rule 245	Validate Personal ID	
↳ Business Rule 39	Cancellation Constraint	
↳ Business Rule 520	Import/ Export allowed guarantee types	
↳ Business Rule 70	EXS exists at the Office of Exit	
↳ Business Rule 71	Manifest number in IE547 and IE590	
BPE1500. Validate Export message against external systems	The system performs message validations against external systems.	Service Task
↳ Business Rule 101	Validate Economic Operator against MEOS	
↳ Business Rule 422	Validation of NCTS notifications	
↳ Business Rule 425	Goods Discharge required	
↳ Business Rule 439	Validate against GMS for integrity check	
↳ Business Rule 440	Validate Economic Operator's TIN against MEOS	
↳ Business Rule 494	Orchestrate validation of Export message against external systems	
↳ Business Rule 508	Validation of Export licenses with EXIM	

CARM Customs Declaration and Excise Documents Processing system (CDEPS)	REF: CDEPS_EXPORT_BPS
Business Process Specifications for EXPORT System	VER:410
↳ Business Rule 509	Check Export authorizations with MEOS
↳ Business Rule 51	Validate declared Combined Nomenclature in Declaration against ITE.
↳ Business Rule 510	Check Export authorizations for representation with MEOS
↳ Business Rule 511	Check Evidence of Power of Attorney with MEOS
↳ Business Rule 521	Validate Export declaration against ITE (duty calculation).
↳ Business Rule 522	Validate Export declaration data against Goods Discharge Tracking system
↳ Business Rule 527	Validate Export Declaration data against Excise system

2.5.3.2 Event(s)

The table below defines the 'Event(s)' of the 'BP0250. Validate Export' process.

Element Name	Description	Special Type
BPE0027. A message or event notification from GUI is received for validation	Message input in the validation process.	Start
BPE0035. Validation completed successfully	The validation is completed successfully with no errors reported. The process terminates.	End
BPE0036. Validation completed with errors	The validation completed with errors. The process terminates.	End

2.5.3.3 Gateway(s)

The table below defines the 'Gateway(s)' of the 'BP0250. Validate Export' process.

Element Name	Description	Special Type
BPE1514. Merge Invalid Errors	Combines exclusively either the negative outcome of generic validate process (BP0005. Validate) which reports errors or the errors from the extra checks for the specific system.	Merge

CARM Customs Declaration and Excise Documents Processing system (CDEPS)	REF: CDEPS_EXPORT_BPS
Business Process Specifications for EXPORT System	VER:410

2.5.4.BP0132. Handle Exit Notification

Business Process Description

The following table provides general information about the 'BP0132. Handle Exit Notification' process. The Business Process Diagram and the description of various business process elements are specified in the following paragraphs.

Description	The process describes the actions performed by the system in order to handle the received Exit Notification
Precondition(s)	Exit Notification is received
Trigger	The process is triggered when an Exit Notification is received.
Postcondition(s)	- None - Exited

Business Process Diagram

The Business Process Diagram of 'BP0132. Handle Exit Notification' is shown below in BPMN notation. The definition of a process that might be used as sub-process by the 'BP0132. Handle Exit Notification' can be found in this document. Finally, Annex A of CDEPS-BPS-EXPORT provides some explanatory information about the used notation.

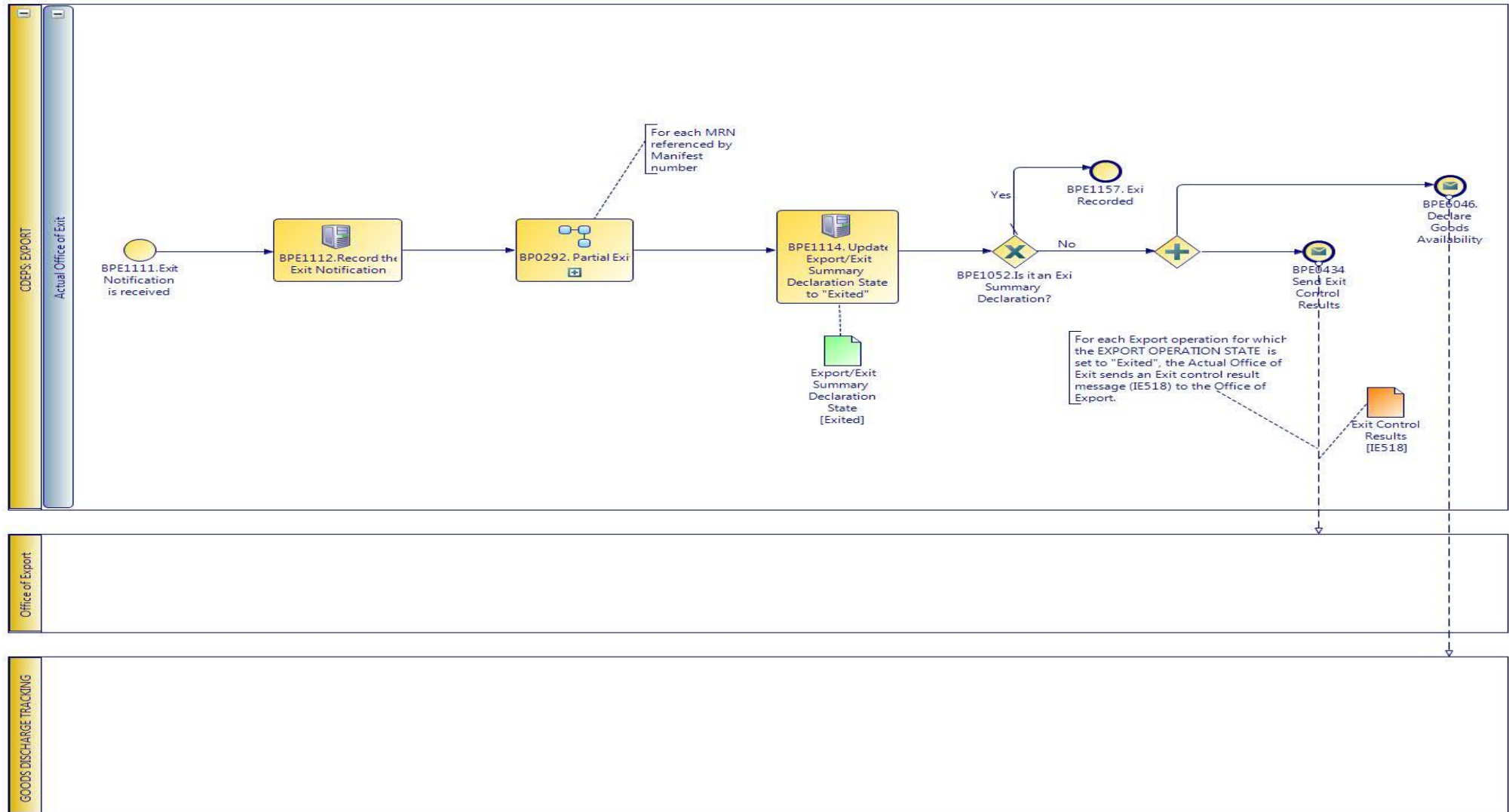

CARM Customs Declaration and Excise Documents Processing system (CDEPS)	REF: CDEPS_EXPORT_BPS
Business Process Specifications for EXPORT System	VER:410

2.5.4.1 Activities

The table below defines the 'Activities' of the 'BP0132. Handle Exit Notification' process.

Element Name	Description	Special Type
BPE0556. Reject Exit Notification	In case of validation errors identified, reject Exit Notification	User Task
BPE1112. Record the Exit Notification	The validated Exit Notification received by the Local Authority at Exit is being recorded into the system.	Service Task
BPE1114. Update Export/Exit Summary Declaration State to "Exited"	The system updates the Export/Exit Summary Declaration state to "Exited" upon the total exit of the goods.	Service Task

2.5.4.2 Event(s)

The table below defines the 'Event(s)' of the 'BP0132. Handle Exit Notification' process.

Element Name	Description	Special Type
BPE0434. Send Exit Control Results	The system at the Office of Exit sends the exit control results (IE518) to the Office of Export.	End
BPE1111. Exit Notification is received	The system receives the Exit Notification by the Local Authority at Exit and the process begins.	Start
BPE1157. Exit Recorded	The Exit Summary declaration has been recorded an the process terminates.	End
BPE6046. Declare Goods Availability	The current document declare its goods as available to be used by upcoming Movements.	End
↳ Business Rule 604	<i>Goods availability to Discharge Module according previous procedure</i>	
↳ Business Rule 605	<i>Goods availability to Discharge Module according procedure</i>	
↳ Business Rule 640	<i>Import declaration type 'X' to discharge module</i>	

CARM Customs Declaration and Excise Documents Processing system (CDEPS)	REF: CDEPS_EXPORT_BPS
Business Process Specifications for EXPORT System	VER:410

2.5.4.3 Gateway(s)

The table below defines the 'Gateway(s)' of the 'BP0132. Handle Exit Notification' process.

Element Name	Description	Special Type
BPE1052. Is it an Exit Summary Declaration?	A decision point on the process to navigate the flow based on the type of the declaration (Export or Exit Summary).	Decision

CARM Customs Declaration and Excise Documents Processing system (CDEPS)	REF: CDEPS_EXPORT_BPS
Business Process Specifications for EXPORT System	VER:410

2.5.5.BP0292. Partial Exit

Business Process Description

The following table provides general information about the 'BP0292. Partial Exit' process. The Business Process Diagram and the description of various business process elements are specified in the following paragraphs.

Description	The process describes the actions performed by the system in order to handle the partial exit
Precondition(s)	Export Goods Item referenced by Manifest Number received
Trigger	The process is triggered when the Export Goods Item referenced by Manifest Number are received.
Postcondition(s)	- None - Partially Exited

Business Process Diagram

The Business Process Diagram of 'BP0292. Partial Exit' is shown below in BPMN notation. The definition of a process that might be used as sub-process by the 'BP0292. Partial Exit' can be found in this document. Finally, Annex A of CDEPS-BPS-EXPORT provides some explanatory information about the used notation.

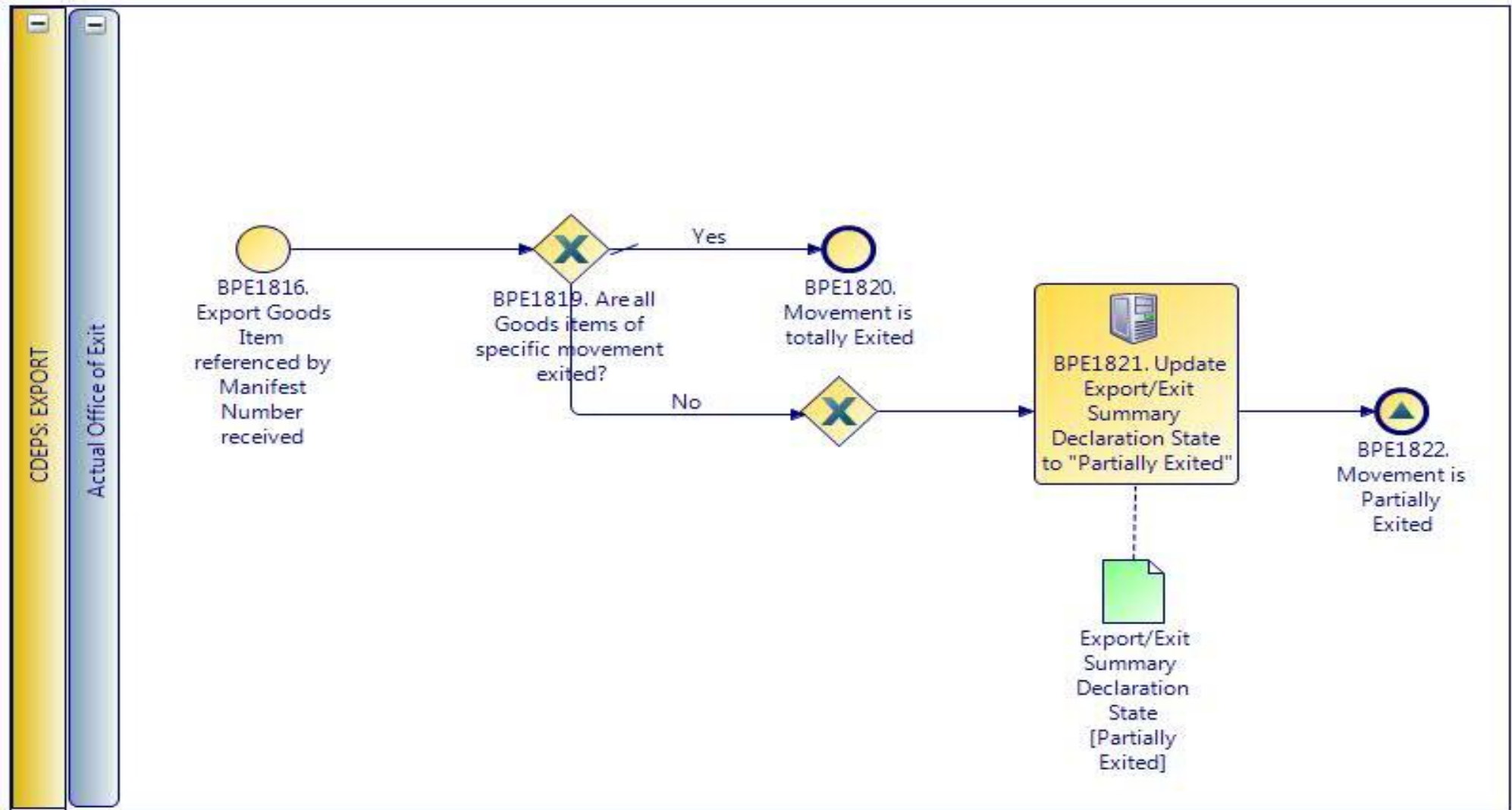

CARM Customs Declaration and Excise Documents Processing system (CDEPS)	REF: CDEPS_EXPORT_BPS
Business Process Specifications for EXPORT System	VER:410

2.5.5.1 Activities

The table below defines the 'Activities' of the 'BP0292. Partial Exit' process.

Element Name	Description	Special Type
BPE1821. Update Export/Exit Summary Declaration State to "Partially Exited"	The system updates the Export/Exit Summary Declaration State to "Partially Exited".	Service Task

2.5.5.2 Event(s)

The table below defines the 'Event(s)' of the 'BP0292. Partial Exit' process.

Element Name	Description	Special Type
BPE1816. Export Goods Item referenced by Manifest Number received	Export Goods Item referenced by Manifest Number received	Start
BPE1820. Movement is totally Exited	The Movement is totally Exited and the process terminates.	End
BPE1822. Movement is Partially Exited	The Movement is Partially Exited and the process terminates.	End

2.5.5.3 Gateway(s)

The table below defines the 'Gateway(s)' of the 'BP0292. Partial Exit' process.

Element Name	Description	Special Type
BPE1819. Are all Goods items of specific movement exited?	A decision point in the process to navigate the flow based on whether all the goods of a specific movement are exited?	Decision

↳ **Business Rule** 68 *Check Partial Exit*

CARM Customs Declaration and Excise Documents Processing system (CDEPS)	REF: CDEPS_EXPORT_BPS
Business Process Specifications for EXPORT System	VER:410

2.5.6.BP0005. Validate

Business Process Description

The following table provides general information about the 'BP0005. Validate' process. The Business Process Diagram and the description of various business process elements are specified in the following paragraphs.

Description	Reusable subprocess that performs the message validation tasks
Precondition(s)	None
Trigger	The process is triggered when an electronic message is received for validation.
Postcondition(s)	

Business Process Diagram

The Business Process Diagram of 'BP0005. Validate' is shown below in BPMN notation. The definition of a process that might be used as sub-process by the 'BP0005. Validate' can be found in this document. Finally, Annex A of CDEPS-BPS-EXPORT provides some explanatory information about the used notation.

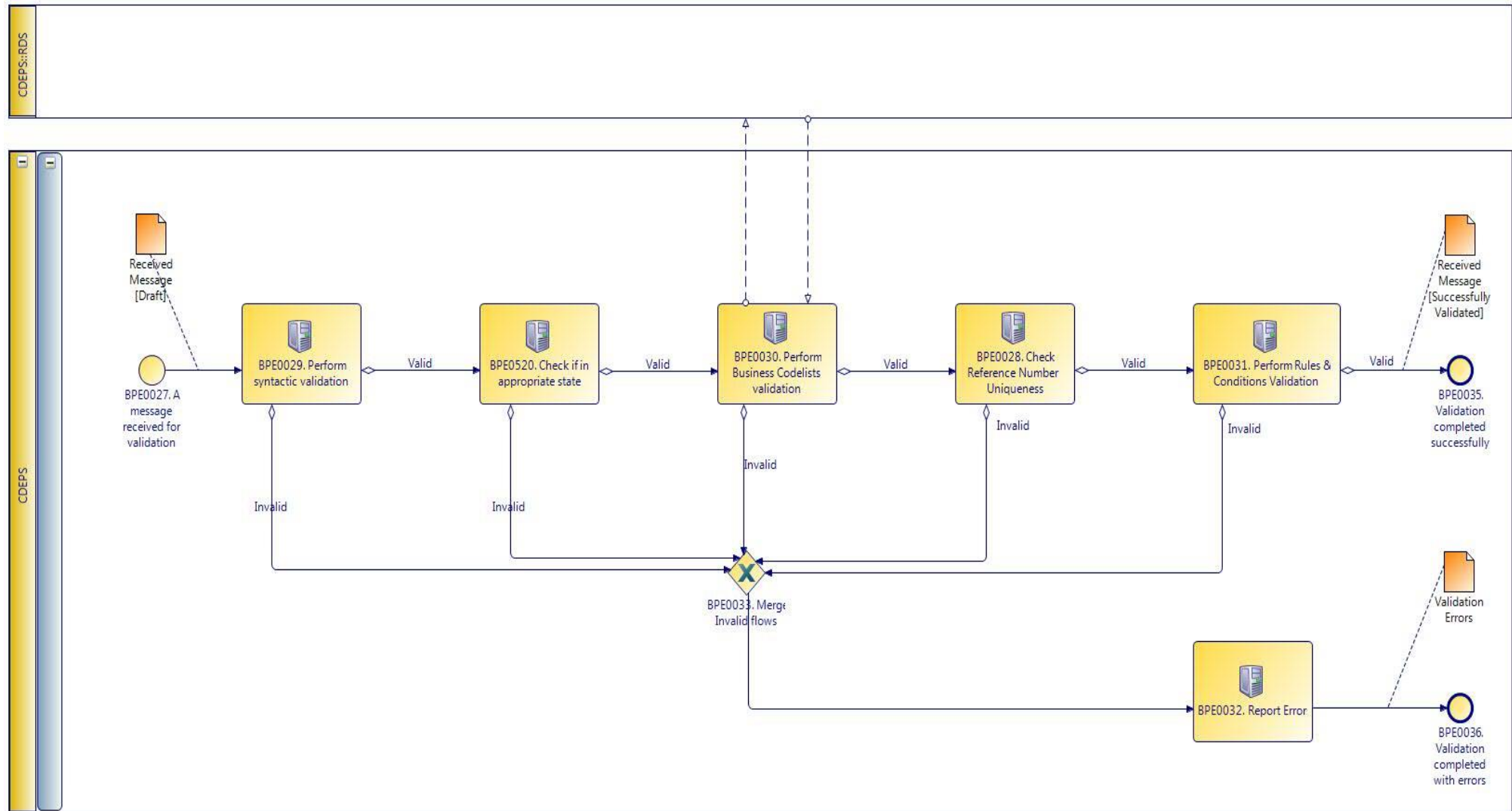

CARM Customs Declaration and Excise Documents Processing system (CDEPS)	REF: CDEPS_EXPORT_BPS
Business Process Specifications for EXPORT System	VER:410

2.5.6.1 Activities

The table below defines the 'Activities' of the 'BP0005. Validate' process.

Element Name	Description	Special Type
BPE0028. Check Reference Number Uniqueness	Check whether message reference numbers are unique in the system.	Service Task
↳ Business Rule 1	<i>Check Message Identification uniqueness</i>	
↳ Business Rule 74	<i>Check Local Reference Number (LRN) uniqueness</i>	
↳ Business Rule 75	<i>Check Movement Reference Number (MRN)uniqueness</i>	
↳ Business Rule 79	<i>Check Manifest reference number uniqueness</i>	
BPE0029. Perform syntactic validation	Check messages against the XSDs.	Service Task
↳ Business Rule 47	<i>Syntactic validation</i>	
BPE0030. Perform Business Codelists validation	Check the message business codelists.	Service Task
↳ Business Rule 50	<i>Business codelist validation against CDEPS:RDS</i>	
BPE0031. Perform Rules & Conditions Validation	Check the rules and conditions of the respective message.	Service Task
BPE0032. Report Errors	Report the identified errors from the validation process. The process terminates.	Service Task
BPE0520. Check if in appropriate state	Check whether the process for the particular entity (e.g. declaration/ application/ document) is on the appropriate state to process the received message. This check shall be performed based on the pertinent State Model of the system.	Service Task
↳ Business Rule 421	<i>Supplementary Declaration validation at Export</i>	
↳ Business Rule 448	<i>Check appropriate state for Export Declaration Amendment</i>	

CARM Customs Declaration and Excise Documents Processing system (CDEPS)	REF: CDEPS_EXPORT_BPS
Business Process Specifications for EXPORT System	VER:410

- ↳ **Business Rule** 449 *Check appropriate state Declaration Goods Presentation*
- ↳ **Business Rule** 468 *Guarantee Amendment*
- ↳ **Business Rule** 492 *Exit control results received at Export*
- ↳ **Business Rule** 493 *Export Declaration request at Export*

2.5.6.2 Event(s)

The table below defines the 'Event(s)' of the 'BP0005. Validate' process.

Element Name	Description	Special Type
BPE0027. A message or event notification from GUI is received for validation	Message input in the validation process.	Start
BPE0035. Validation completed successfully	The validation is completed successfully with no errors reported. The process terminates.	End
BPE0036. Validation completed with errors	The validation completed with errors. The process terminates.	End

2.5.6.3 Gateway(s)

The table below defines the 'Gateway(s)' of the 'BP0005. Validate' process.

Element Name	Description	Special Type
BPE0033. Merge Invalid Flows	Merge into exclusive event based gateway the invalid flows from all validation tasks.	Merge

CARM Customs Declaration and Excise Documents Processing system (CDEPS)	REF: CDEPS_EXPORT_BPS
Business Process Specifications for EXPORT System	VER:410

2.5.7.BP0246. Handle Pre-validation request

Business Process Description

The following table provides general information about the 'BP0246. Handle Pre-validation request' process. The Business Process Diagram and the description of various business process elements are specified in the following paragraphs.

Description	The process handles a request received from the Trader Portal for the pre-validation of any message. The process terminates with either a positive or negative reply back to the Trader Portal.
Precondition(s)	
Trigger	
Postcondition(s)	

Business Process Diagram

The Business Process Diagram of 'BP0246. Handle Pre-validation request' is shown below in BPMN notation. The definition of a process that might be used as sub-process by the 'BP0246. Handle Pre-validation request' can be found in this document. Finally, Annex A of CDEPS-BPS-EXPORT provides some explanatory information about the used notation.

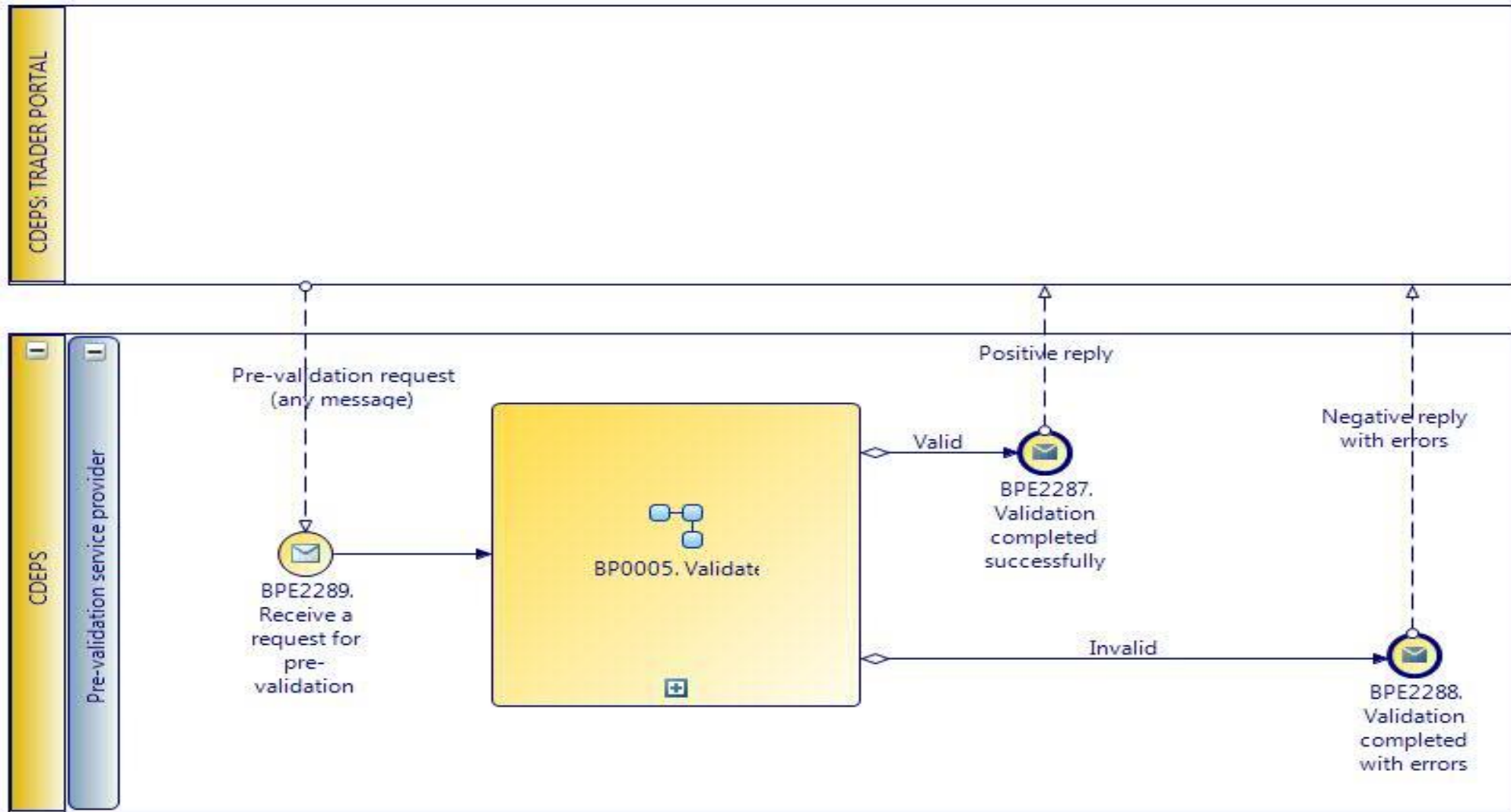

CARM Customs Declaration and Excise Documents Processing system (CDEPS)	REF: CDEPS_EXPORT_BPS
Business Process Specifications for EXPORT System	VER:410

2.5.7.1 Event(s)

The table below defines the 'Event(s)' of the 'BP0246. Handle Pre-validation request' process.

Element Name	Description	Special Type
BPE2287. Validation completed successfully	The validation is completed successfully with no errors reported. The process terminates and informs requesting system accordingly.	End
BPE2288. Validation completed with errors	The validation completed with errors. The process terminates and informs requesting system accordingly.	End
BPE2289. Receive a request for pre-validation	A pre-validation request is received from Trader Portal for a specific message.	Start

CARM Customs Declaration and Excise Documents Processing system (CDEPS)	REF: CDEPS_EXPORT_BPS
Business Process Specifications for EXPORT System	VER:410

2.6. Process Group: Export operation Follow – Up at Export

2.6.1.BP0146. Process Follow - Up @ Office of Export

Business Process Description

The following table provides general information about the 'BP0146. Process Follow - Up @ Office of Export' process. The Business Process Diagram and the description of various business process elements are specified in the following paragraphs.

Description	A high level process describing the actions performed by the system in order to process the follow-up request at the office of Export.
Precondition(s)	Follow - Up timer expired
Trigger	The process is triggered when the follow up timer expires
Postcondition(s)	<ul style="list-style-type: none"> - None - Goods Released for Export - Under Cancellation Decision

Business Process Diagram

The Business Process Diagram of 'BP0146. Process Follow - Up @ Office of Export' is shown below in BPMN notation. The definition of a process that might be used as sub-process by the 'BP0146. Process Follow - Up @ Office of Export' can be found in this document. Finally, Annex A of CDEPS-BPS-EXPORT provides some explanatory information about the used notation.

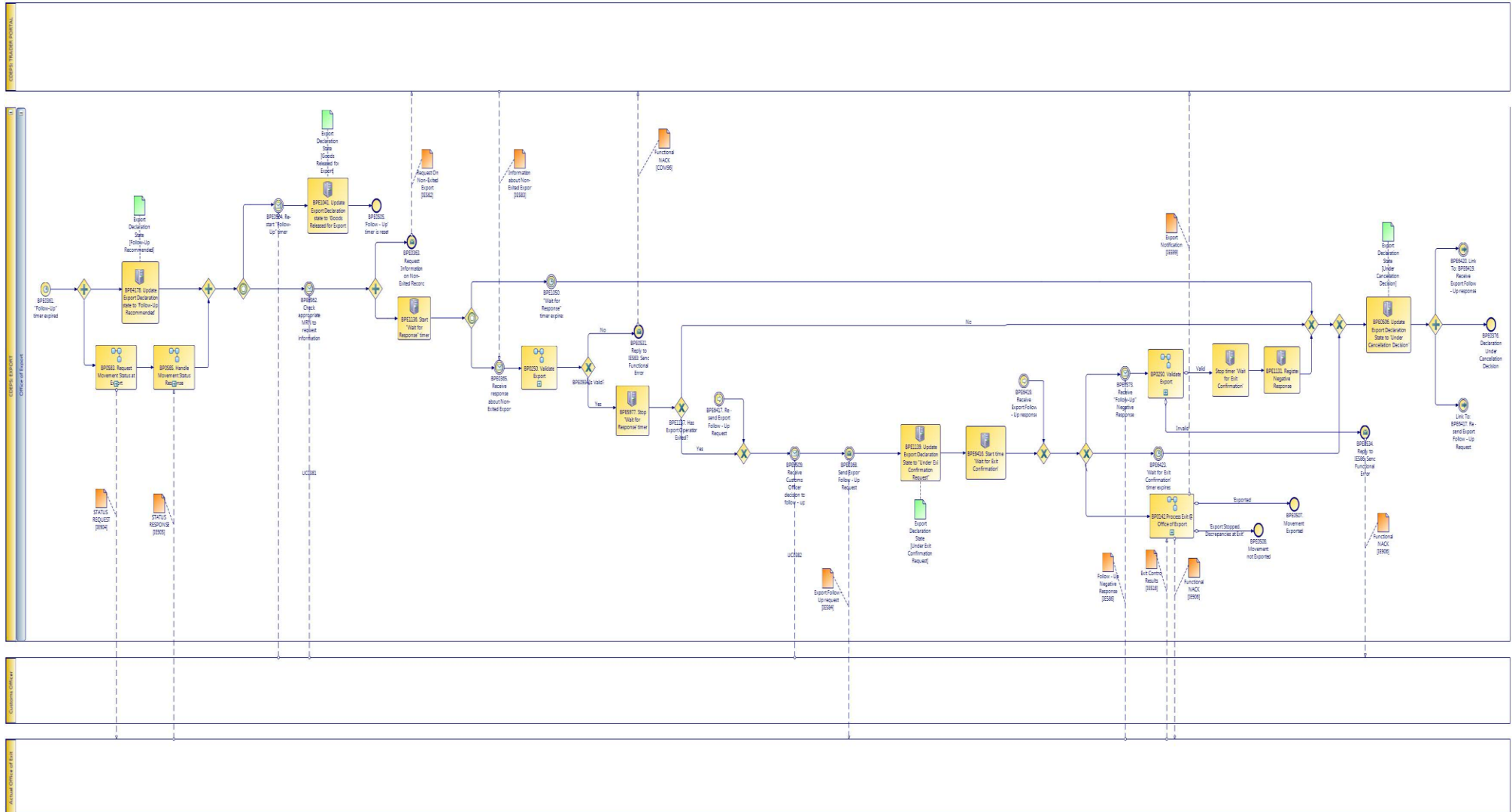

CARM Customs Declaration and Excise Documents Processing system (CDEPS)	REF: CDEPS_EXPORT_BPS
Business Process Specifications for EXPORT System	VER:410

2.6.1.1 Activities

The table below defines the 'Activities' of the 'BP0146. Process Follow - Up @ Office of Export' process.

Element Name	Description	Special Type
BPE0362. Check appropriate MRN to "Follow-Up"	The system automatically retrieves the export operation information identified by the MRN brought in the timer 'Follow-up timer' and notifies the Customs Officer, that it is time to start its follow-up.	Service Task
BPE0506. Update Export Declaration State to 'Under Cancellation Decision'	The system updates the Export Declaration State to 'Under Cancellation Decision'	Service Task
BPE1041. Update Export Declaration State to "Goods Released for Export"	The system updates the state of the declaration to "Goods Released for Export" upon the release of the movement for export.	Service Task
BPE1131. Register Negative Response	The system registers the follow - up negative response	Service Task
BPE1139. Update Export Declaration State to "Under Exit Confirmation Request"	The system updates the Export Declaration State to "Under Exit Confirmation Request"	Service Task
BPE4178. Update Export Declaration state to 'Follow-Up Recommended'	The System updates the Export Declaration state to 'Follow-Up Recommended'	Service Task
BPE5977. Stop 'Wait for Response' timer	The 'Wait for Response' timer is stopped upon the reception of a valid response on Non-Exited Movements (IE583)	Service Task

CARM Customs Declaration and Excise Documents Processing system (CDEPS)	REF: CDEPS_EXPORT_BPS
Business Process Specifications for EXPORT System	VER:410

BPE5986. Update Export Declaration State to "Goods Released for Export with Transit"	The system updates the Export Declaration State to "Goods Released for Export with Transit"	Service Task
BPE6416. Start timer 'Wait for Exit Confirmation'	Start timer 'Wait for Exit Confirmation'	Service Task

2.6.1.2 Event(s)

The table below defines the 'Event(s)' of the 'BP0146. Process Follow - Up @ Office of Export' process.

Element Name	Description	Special Type
BPE0361. "Follow-Up" timer expired	The time allotted for the receipt of the exit confirmation has expired. This time-out indicates that a follow-up should start. A Customs Officer may manually adjust the value of this "timer", where necessary. When the exit confirmation (IE518) is received from the Office of Exit, or when the export operation is cancelled, the timer is stopped.	Start
BPE0363. Request Information on Non-Exited Record	This process demands always an intervention of a Customs Officer. The Customs Officer asks (IE582) the Exporter/Declarant for information regarding the whereabouts of the export operation for which no exit confirmation has been received.	End
BPE0365. Receive response about Non-Exited Export	The system catch a response from the Exporter Trader about the not-exited export.	Intermediate
BPE0368. Send Export Follow - Up Request	The system sends an exit confirmation request (IE584) to the Office of Exit indicated by the Exporter/Declarant in his response. The request contains information obtained from the Exporter/Declarant which will be relevant to the Office of Exit (e.g. the 'Exit date', date at which the Exporter/Declarant claims that export operation had exited). Constraint: The Office of Export may send more than one exit confirmation requests (IE584), in particular if either a follow up negative response (IE586) or no response at all had been received in a first place.	Intermediate

CARM Customs Declaration and Excise Documents Processing system (CDEPS)	REF: CDEPS_EXPORT_BPS
Business Process Specifications for EXPORT System	VER:410
BPE0373. Receive "Follow-Up" Negative Response	The system at the OfExp receives a negative follow up response (IE586) from the OoExt. Intermediate
BPE0504. Re-start "Follow-Up" timer	The Customs Officer selects to restart the expired follow-up timer Intermediate
BPE0505. 'Follow - Up' timer is reset	The 'Follow - Up' timer is reset End
BPE0507. Movement Exported	Movement Exported End
BPE0508. Movement not Exported	Movement not Exported End
BPE0509. Receive Customs Officer decision to follow - up	The System receives the Customs Officer's decision to follow - up Intermediate
BPE0531. Reply to IE583: Send Functional Error	Send a functional error in case of IE583 rejection End
BPE0534. Reply to IE586: Send Functional Error	Reply to the invalid message with a functional error (IE906) End
BPE1050. "Wait for Response" timer expires	"Wait for Response" timer expires Intermediate
BPE6417. Re -send Export Follow - Up Request	Re -send Export Follow - Up Request Intermediate
↳ Business Rule 556	<i>Handle delayed IE583 message</i>
BPE6418. Link To: BPE6417. Re -send Export Follow - Up Request	Link To: BPE6417. Re -send Export Follow - Up Request Intermediate

CARM Customs Declaration and Excise Documents Processing system (CDEPS)	REF: CDEPS_EXPORT_BPS
Business Process Specifications for EXPORT System	VER:410

BPE6419. Receive Export Follow - Up response	Receive Export Follow - Up response	Intermediate
BPE6420. Link To:	Link To: BPE6419. Receive Export Follow - Up response	Intermediate
BPE6419. Receive Export Follow - Up response		
BPE6423. 'Wait for Exit Confirmation' timer expires	The 'Wait for Exit Confirmation' timer expires	Intermediate

2.6.1.3 Gateway(s)

The table below defines the 'Gateway(s)' of the 'BP0146. Process Follow - Up @ Office of Export' process.

Element Name	Description	Special Type
BPE0934. Is Valid?	A decision point in the process to navigate the flow based on the message validation result.	Decision
↳ Business Rule	638 <i>Import declaration type 'X' cannot be cancelled</i>	
↳ Business Rule	646 <i>Guarantees during the registration of Import declaration type 'X'</i>	
↳ Business Rule	80 <i>Valid Message</i>	
BPE1137. Has Export Operation Exited?	A decision point in the process to navigate the flow based on whether the export movement has exited	Decision
BPE5985. Transit procedure follows?	A decision point in the flow to navigate the process based on whether the goods released for Export followed by the Transit procedure or not.	Decision

CARM Customs Declaration and Excise Documents Processing system (CDEPS)	REF: CDEPS_EXPORT_BPS
Business Process Specifications for EXPORT System	VER:410

2.6.2.BP0250. Validate Export

Business Process Description

The following table provides general information about the 'BP0250. Validate Export' process. The Business Process Diagram and the description of various business process elements are specified in the following paragraphs.

Description	Reusable subprocess that performs the message validation tasks for Export Regime.
Precondition(s)	None
Trigger	The process is triggered when an electronic message is received for validation.
Postcondition(s)	The validation is either completed successfully or with errors reported

Business Process Diagram

The Business Process Diagram of 'BP0250. Validate Export' is shown below in BPMN notation. The definition of a process that might be used as sub-process by the 'BP0250. Validate Export' can be found in this document. Finally, Annex A of CDEPS-BPS-EXPORT provides some explanatory information about the used notation.

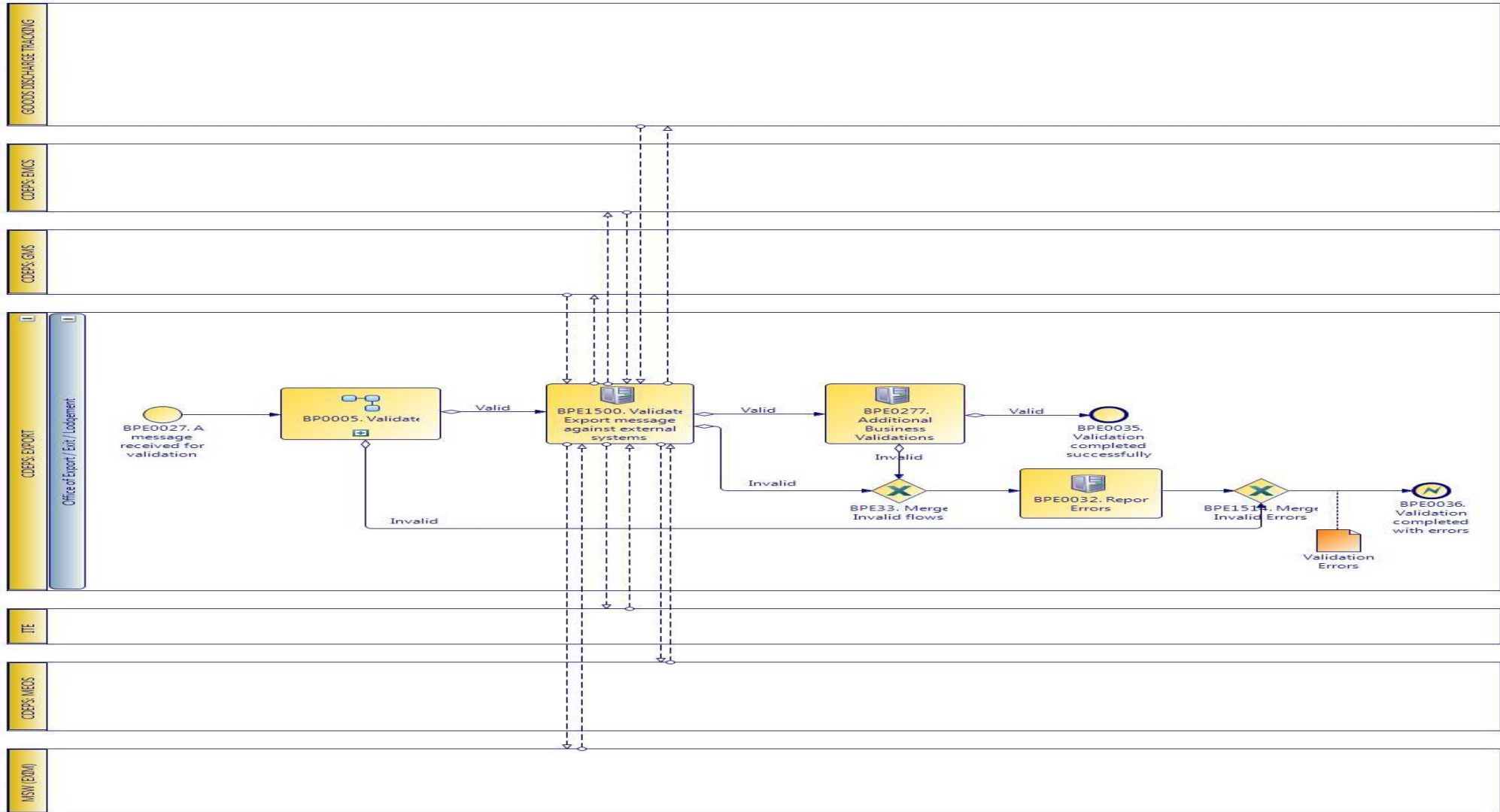

CARM Customs Declaration and Excise Documents Processing system (CDEPS)	REF: CDEPS_EXPORT_BPS
Business Process Specifications for EXPORT System	VER:410

2.6.2.1 Activities

The table below defines the 'Activities' of the 'BP0250. Validate Export' process.

Element Name	Description	Special Type
BPE0032. Report Errors	Report the identified errors from the validation process. The process terminates.	Service Task
BPE0277. Additional Business Validations for Export	The system performs any additional business validations specific to Export System.	Service Task
↳ Business Rule 19	Trader amending data same as Person lodging the declaration	
↳ Business Rule 21	Reject ENS/EXS amendment if ENS/EXS is not in appropriate state	
↳ Business Rule 245	Validate Personal ID	
↳ Business Rule 39	Cancellation Constraint	
↳ Business Rule 520	Import/ Export allowed guarantee types	
↳ Business Rule 70	EXS exists at the Office of Exit	
↳ Business Rule 71	Manifest number in IE547 and IE590	
BPE1500. Validate Export message against external systems	The system performs message validations against external systems.	Service Task
↳ Business Rule 101	Validate Economic Operator against MEOS	
↳ Business Rule 422	Validation of NCTS notifications	
↳ Business Rule 425	Goods Discharge required	
↳ Business Rule 439	Validate against GMS for integrity check	
↳ Business Rule 440	Validate Economic Operator's TIN against MEOS	
↳ Business Rule 494	Orchestrate validation of Export message against external systems	
↳ Business Rule 508	Validation of Export licenses with EXIM	

CARM Customs Declaration and Excise Documents Processing system (CDEPS)	REF: CDEPS_EXPORT_BPS
Business Process Specifications for EXPORT System	VER:410
↳ Business Rule 509	Check Export authorizations with MEOS
↳ Business Rule 51	Validate declared Combined Nomenclature in Declaration against ITE.
↳ Business Rule 510	Check Export authorizations for representation with MEOS
↳ Business Rule 511	Check Evidence of Power of Attorney with MEOS
↳ Business Rule 521	Validate Export declaration against ITE (duty calculation).
↳ Business Rule 522	Validate Export declaration data against Goods Discharge Tracking system
↳ Business Rule 527	Validate Export Declaration data against Excise system

2.6.2.2 Event(s)

The table below defines the 'Event(s)' of the 'BP0250. Validate Export' process.

Element Name	Description	Special Type
BPE0027. A message or event notification from GUI is received for validation	Message input in the validation process.	Start
BPE0035. Validation completed successfully	The validation is completed successfully with no errors reported. The process terminates.	End
BPE0036. Validation completed with errors	The validation completed with errors. The process terminates.	End

2.6.2.3 Gateway(s)

The table below defines the 'Gateway(s)' of the 'BP0250. Validate Export' process.

Element Name	Description	Special Type
BPE1514. Merge Invalid Errors	Combines exclusively either the negative outcome of generic validate process (BP0005. Validate) which reports errors or the errors from the extra checks for the specific system.	Merge

CARM Customs Declaration and Excise Documents Processing system (CDEPS)	REF: CDEPS_EXPORT_BPS
Business Process Specifications for EXPORT System	VER:410

2.6.3.BP0005. Validate

Business Process Description

The following table provides general information about the 'BP0005. Validate' process. The Business Process Diagram and the description of various business process elements are specified in the following paragraphs.

Description	Reusable subprocess that performs the message validation tasks
Precondition(s)	None
Trigger	The process is triggered when an electronic message is received for validation.
Postcondition(s)	

Business Process Diagram

The Business Process Diagram of 'BP0005. Validate' is shown below in BPMN notation. The definition of a process that might be used as sub-process by the 'BP0005. Validate' can be found in this document. Finally, Annex A of CDEPS-BPS-EXPORT provides some explanatory information about the used notation.

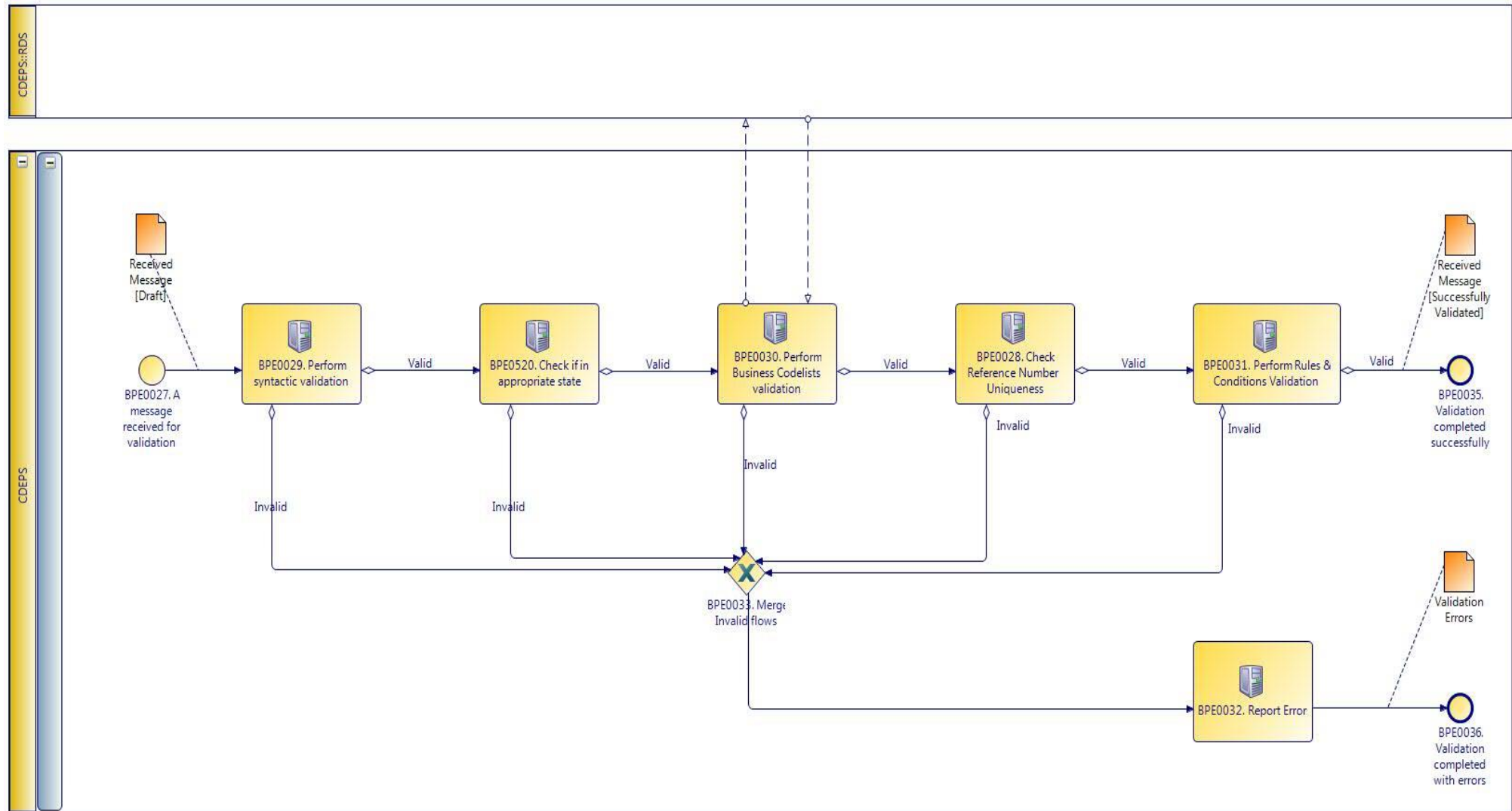

CARM Customs Declaration and Excise Documents Processing system (CDEPS)	REF: CDEPS_EXPORT_BPS
Business Process Specifications for EXPORT System	VER:410

2.6.3.1 Activities

The table below defines the 'Activities' of the 'BP0005. Validate' process.

Element Name	Description	Special Type
BPE0028. Check Reference Number Uniqueness	Check whether message reference numbers are unique in the system.	Service Task
↳ Business Rule 1	<i>Check Message Identification uniqueness</i>	
↳ Business Rule 74	<i>Check Local Reference Number (LRN) uniqueness</i>	
↳ Business Rule 75	<i>Check Movement Reference Number (MRN)uniqueness</i>	
↳ Business Rule 79	<i>Check Manifest reference number uniqueness</i>	
BPE0029. Perform syntactic validation	Check messages against the XSDs.	Service Task
↳ Business Rule 47	<i>Syntactic validation</i>	
BPE0030. Perform Business Codelists validation	Check the message business codelists.	Service Task
↳ Business Rule 50	<i>Business codelist validation against CDEPS:RDS</i>	
BPE0031. Perform Rules & Conditions Validation	Check the rules and conditions of the respective message.	Service Task
BPE0032. Report Errors	Report the identified errors from the validation process. The process terminates.	Service Task
BPE0520. Check if in appropriate state	Check whether the process for the particular entity (e.g. declaration/ application/ document) is on the appropriate state to process the received message. This check shall be performed based on the pertinent State Model of the system.	Service Task
↳ Business Rule 421	<i>Supplementary Declaration validation at Export</i>	
↳ Business Rule 448	<i>Check appropriate state for Export Declaration Amendment</i>	

CARM Customs Declaration and Excise Documents Processing system (CDEPS)	REF: CDEPS_EXPORT_BPS
Business Process Specifications for EXPORT System	VER:410

- ↳ **Business Rule** 449 *Check appropriate state Declaration Goods Presentation*
- ↳ **Business Rule** 468 *Guarantee Amendment*
- ↳ **Business Rule** 492 *Exit control results received at Export*
- ↳ **Business Rule** 493 *Export Declaration request at Export*

2.6.3.2 Event(s)

The table below defines the 'Event(s)' of the 'BP0005. Validate' process.

Element Name	Description	Special Type
BPE0027. A message or event notification from GUI is received for validation	Message input in the validation process.	Start
BPE0035. Validation completed successfully	The validation is completed successfully with no errors reported. The process terminates.	End
BPE0036. Validation completed with errors	The validation completed with errors. The process terminates.	End

2.6.3.3 Gateway(s)

The table below defines the 'Gateway(s)' of the 'BP0005. Validate' process.

Element Name	Description	Special Type
BPE0033. Merge Invalid Flows	Merge into exclusive event based gateway the invalid flows from all validation tasks.	Merge

CARM Customs Declaration and Excise Documents Processing system (CDEPS)	REF: CDEPS_EXPORT_BPS
Business Process Specifications for EXPORT System	VER:410

2.7. Process Group: Export operation Follow – Up at Exit

2.7.1.BP0147. Process Follow - Up @ Actual Office of Exit

Business Process Description

The following table provides general information about the 'BP0147. Process Follow - Up @ Actual Office of Exit' process. The Business Process Diagram and the description of various business process elements are specified in the following paragraphs.

Description	A high level process describing the actions performed by the system in order to process the follow-up request at the Actual Office of Exit.
Precondition(s)	<ul style="list-style-type: none"> - None - Goods Not Allowed to Exit - Exited
Trigger	The process is triggered by the Export Follow-Up request received from the Officer of Export
Postcondition(s)	None

Business Process Diagram

The Business Process Diagram of 'BP0147. Process Follow - Up @ Actual Office of Exit' is shown below in BPMN notation. The definition of a process that might be used as sub-process by the 'BP0147. Process Follow - Up @ Actual Office of Exit' can be found in this document. Finally, Annex A of CDEPS-BPS-EXPORT provides some explanatory information about the used notation.

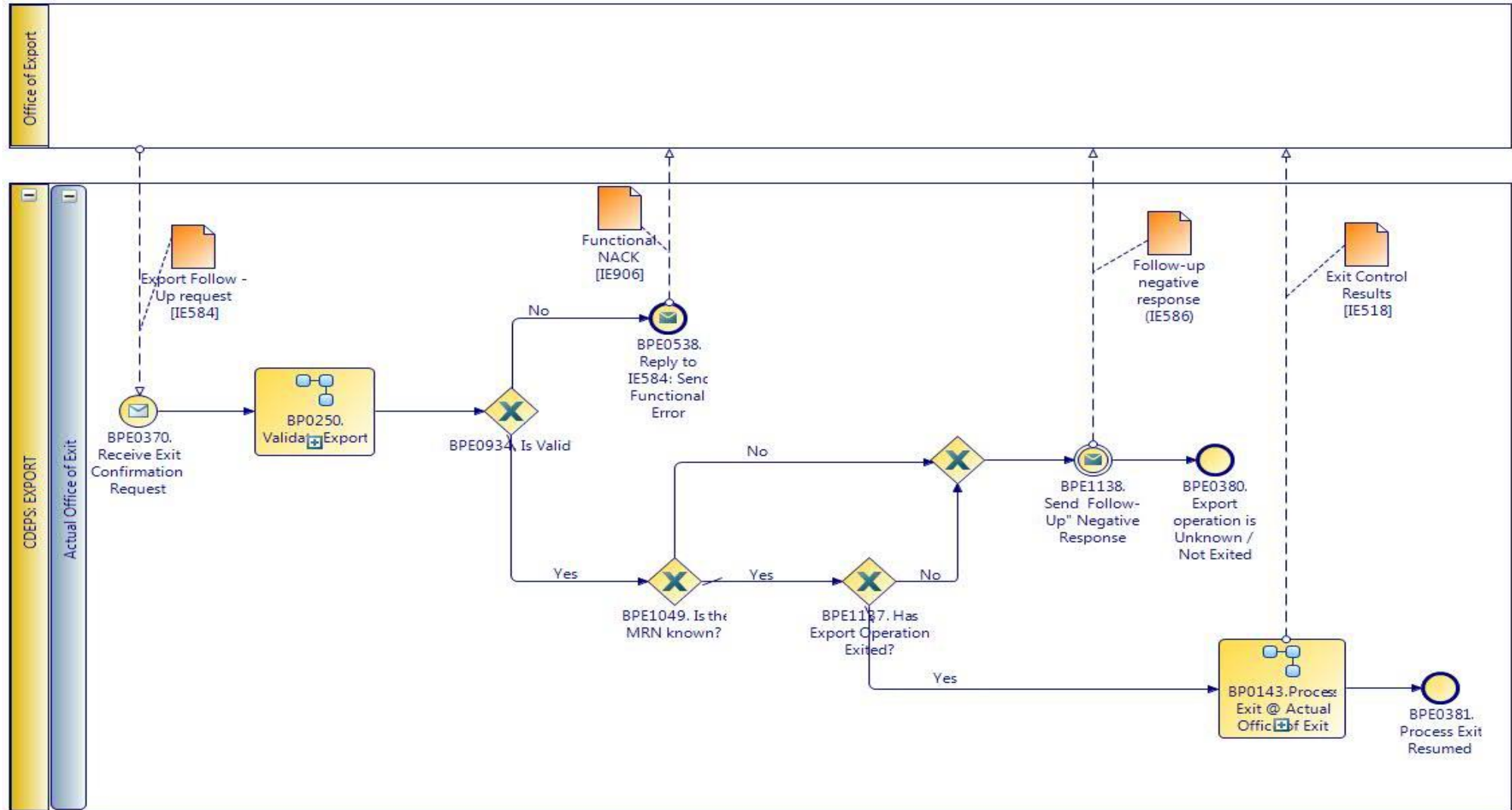

CARM Customs Declaration and Excise Documents Processing system (CDEPS)	REF: CDEPS_EXPORT_BPS
Business Process Specifications for EXPORT System	VER:410

2.7.1.1 Activities

The table below defines the 'Activities' of the 'BP0147. Process Follow - Up @ Actual Office of Exit' process.

Element Name	Description	Special Type
BPE0370. Receive Exit Confirmation Request	The system in the OoExt receives an Exit confirmation request from the OoExp.	User Task

2.7.1.2 Event(s)

The table below defines the 'Event(s)' of the 'BP0147. Process Follow - Up @ Actual Office of Exit' process.

Element Name	Description	Special Type
BPE0380. Export operation is Unknown / Not Exited	The export operation has never been presented/has not exited or normal exit process is resumed.	End
BPE0381. Process Exit Resumed	This is the final event of the follow up process in case of export operation is known at the Office of Exit.	End
BPE0538. Reply to IE584: Send Functional Error	Reply to the invalid message with a functional error (IE906)	End
BPE1138. Send Follow-Up Negative Response	The system sends a Follow-Up Negative Response	Intermediate

2.7.1.3 Gateway(s)

The table below defines the 'Gateway(s)' of the 'BP0147. Process Follow - Up @ Actual Office of Exit' process.

Element Name	Description	Special Type
BPE0934. Is Valid?	A decision point in the process to navigate the flow based on the message validation result.	Decision
↳ Business Rule 638	<i>Import declaration type 'X' cannot be cancelled</i>	
↳ Business Rule 646	<i>Guarantees during the registration of Import declaration type 'X'</i>	
↳ Business Rule 80	<i>Valid Message</i>	

CARM Customs Declaration and Excise Documents Processing system (CDEPS)		REF: CDEPS_EXPORT_BPS
Business Process Specifications for EXPORT System		VER:410
BPE1049. Is the MRN known?	A check point on the flow to decide whether the MRN brought by the declaration request is known.	Decision
BPE1137. Has Export Operation Exited?	A decision point in the process to navigate the flow based on whether the export movement has exited	Decision

CARM Customs Declaration and Excise Documents Processing system (CDEPS)	REF: CDEPS_EXPORT_BPS
Business Process Specifications for EXPORT System	VER:410

2.7.2.BP0250. Validate Export

Business Process Description

The following table provides general information about the 'BP0250. Validate Export' process. The Business Process Diagram and the description of various business process elements are specified in the following paragraphs.

Description	Reusable subprocess that performs the message validation tasks for Export Regime.
Precondition(s)	None
Trigger	The process is triggered when an electronic message is received for validation.
Postcondition(s)	The validation is either completed successfully or with errors reported

Business Process Diagram

The Business Process Diagram of 'BP0250. Validate Export' is shown below in BPMN notation. The definition of a process that might be used as sub-process by the 'BP0250. Validate Export' can be found in this document. Finally, Annex A of CDEPS-BPS-EXPORT provides some explanatory information about the used notation.

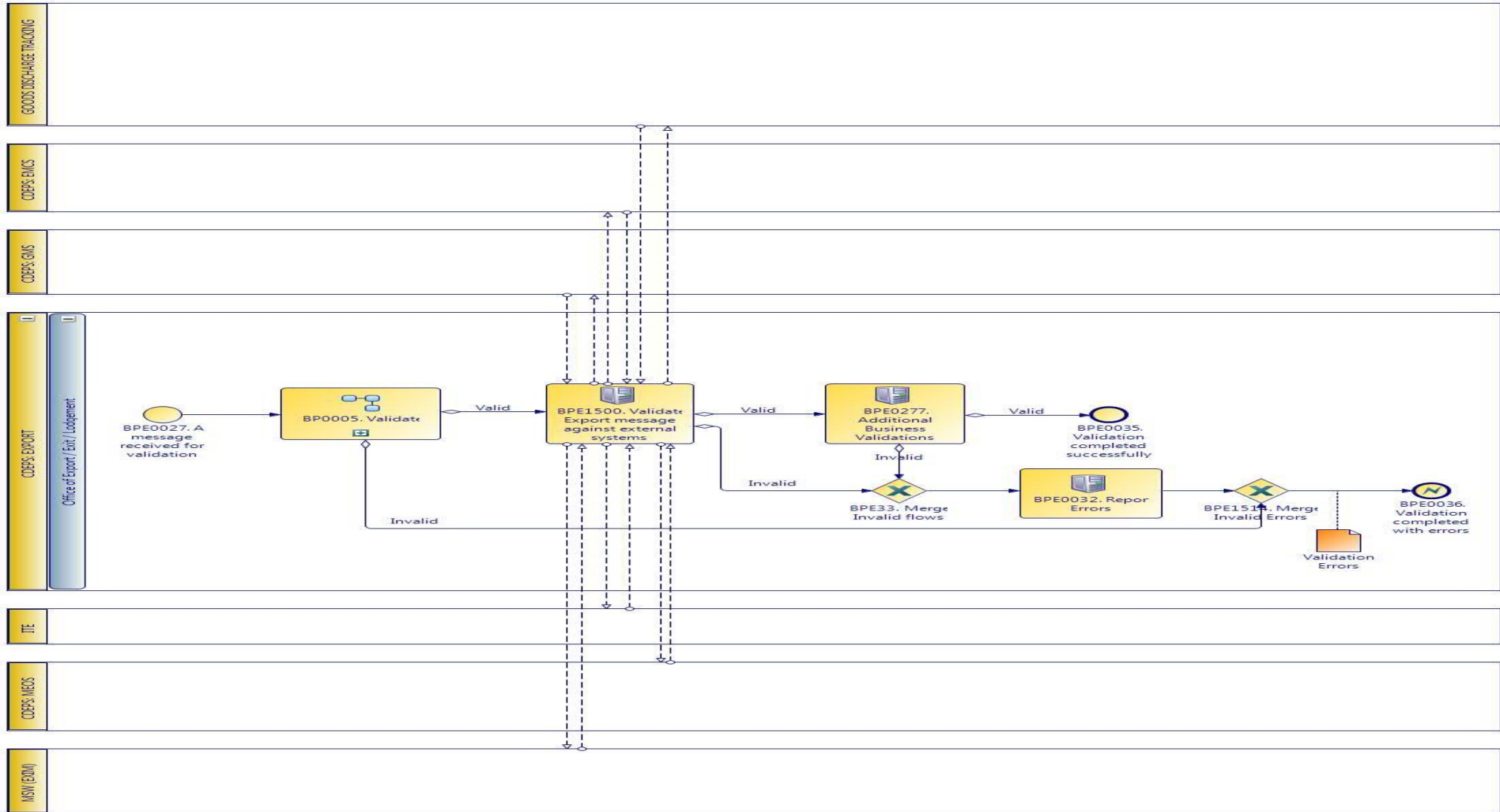

CARM Customs Declaration and Excise Documents Processing system (CDEPS)	REF: CDEPS_EXPORT_BPS
Business Process Specifications for EXPORT System	VER:410

2.7.2.1 Activities

The table below defines the 'Activities' of the 'BP0250. Validate Export' process.

Element Name	Description	Special Type
BPE0032. Report Errors	Report the identified errors from the validation process. The process terminates.	Service Task
BPE0277. Additional Business Validations for Export	The system performs any additional business validations specific to Export System.	Service Task
↳ Business Rule 19	Trader amending data same as Person lodging the declaration	
↳ Business Rule 21	Reject ENS/EXS amendment if ENS/EXS is not in appropriate state	
↳ Business Rule 245	Validate Personal ID	
↳ Business Rule 39	Cancellation Constraint	
↳ Business Rule 520	Import/ Export allowed guarantee types	
↳ Business Rule 70	EXS exists at the Office of Exit	
↳ Business Rule 71	Manifest number in IE547 and IE590	
BPE1500. Validate Export message against external systems	The system performs message validations against external systems.	Service Task
↳ Business Rule 101	Validate Economic Operator against MEOS	
↳ Business Rule 422	Validation of NCTS notifications	
↳ Business Rule 425	Goods Discharge required	
↳ Business Rule 439	Validate against GMS for integrity check	
↳ Business Rule 440	Validate Economic Operator's TIN against MEOS	
↳ Business Rule 494	Orchestrate validation of Export message against external systems	
↳ Business Rule 508	Validation of Export licenses with EXIM	

CARM Customs Declaration and Excise Documents Processing system (CDEPS)	REF: CDEPS_EXPORT_BPS
Business Process Specifications for EXPORT System	VER:410
↳ Business Rule 509	Check Export authorizations with MEOS
↳ Business Rule 51	Validate declared Combined Nomenclature in Declaration against ITE.
↳ Business Rule 510	Check Export authorizations for representation with MEOS
↳ Business Rule 511	Check Evidence of Power of Attorney with MEOS
↳ Business Rule 521	Validate Export declaration against ITE (duty calculation).
↳ Business Rule 522	Validate Export declaration data against Goods Discharge Tracking system
↳ Business Rule 527	Validate Export Declaration data against Excise system

2.7.2.2 Event(s)

The table below defines the 'Event(s)' of the 'BP0250. Validate Export' process.

Element Name	Description	Special Type
BPE0027. A message or event notification from GUI is received for validation	Message input in the validation process.	Start
BPE0035. Validation completed successfully	The validation is completed successfully with no errors reported. The process terminates.	End
BPE0036. Validation completed with errors	The validation completed with errors. The process terminates.	End

2.7.2.3 Gateway(s)

The table below defines the 'Gateway(s)' of the 'BP0250. Validate Export' process.

Element Name	Description	Special Type
BPE1514. Merge Invalid Errors	Combines exclusively either the negative outcome of generic validate process (BP0005. Validate) which reports errors or the errors from the extra checks for the specific system.	Merge

CARM Customs Declaration and Excise Documents Processing system (CDEPS)	REF: CDEPS_EXPORT_BPS
Business Process Specifications for EXPORT System	VER:410

2.7.3.BP0005. Validate

Business Process Description

The following table provides general information about the 'BP0005. Validate' process. The Business Process Diagram and the description of various business process elements are specified in the following paragraphs.

Description	Reusable subprocess that performs the message validation tasks
Precondition(s)	None
Trigger	The process is triggered when an electronic message is received for validation.
Postcondition(s)	

Business Process Diagram

The Business Process Diagram of 'BP0005. Validate' is shown below in BPMN notation. The definition of a process that might be used as sub-process by the 'BP0005. Validate' can be found in this document. Finally, Annex A of CDEPS-BPS-EXPORT provides some explanatory information about the used notation.

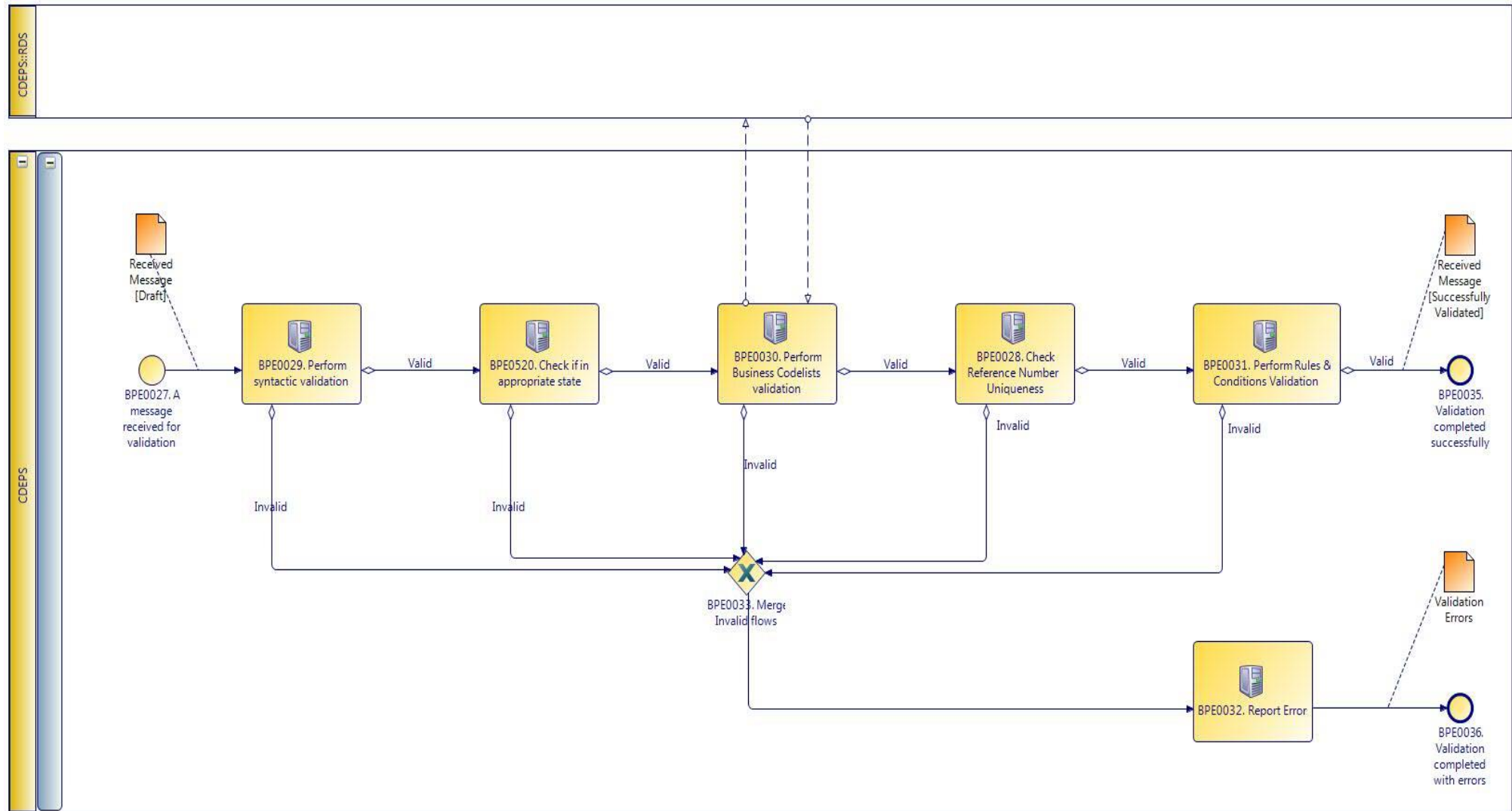

CARM Customs Declaration and Excise Documents Processing system (CDEPS)	REF: CDEPS_EXPORT_BPS
Business Process Specifications for EXPORT System	VER:410

2.7.3.1 Activities

The table below defines the 'Activities' of the 'BP0005. Validate' process.

Element Name	Description	Special Type
BPE0028. Check Reference Number Uniqueness	Check whether message reference numbers are unique in the system.	Service Task
↳ Business Rule 1	<i>Check Message Identification uniqueness</i>	
↳ Business Rule 74	<i>Check Local Reference Number (LRN) uniqueness</i>	
↳ Business Rule 75	<i>Check Movement Reference Number (MRN)uniqueness</i>	
↳ Business Rule 79	<i>Check Manifest reference number uniqueness</i>	
BPE0029. Perform syntactic validation	Check messages against the XSDs.	Service Task
↳ Business Rule 47	<i>Syntactic validation</i>	
BPE0030. Perform Business Codelists validation	Check the message business codelists.	Service Task
↳ Business Rule 50	<i>Business codelist validation against CDEPS:RDS</i>	
BPE0031. Perform Rules & Conditions Validation	Check the rules and conditions of the respective message.	Service Task
BPE0032. Report Errors	Report the identified errors from the validation process. The process terminates.	Service Task
BPE0520. Check if in appropriate state	Check whether the process for the particular entity (e.g. declaration/ application/ document) is on the appropriate state to process the received message. This check shall be performed based on the pertinent State Model of the system.	Service Task
↳ Business Rule 421	<i>Supplementary Declaration validation at Export</i>	
↳ Business Rule 448	<i>Check appropriate state for Export Declaration Amendment</i>	

CARM Customs Declaration and Excise Documents Processing system (CDEPS)	REF: CDEPS_EXPORT_BPS
Business Process Specifications for EXPORT System	VER:410

- ↳ **Business Rule** 449 *Check appropriate state Declaration Goods Presentation*
- ↳ **Business Rule** 468 *Guarantee Amendment*
- ↳ **Business Rule** 492 *Exit control results received at Export*
- ↳ **Business Rule** 493 *Export Declaration request at Export*

2.7.3.2 Event(s)

The table below defines the 'Event(s)' of the 'BP0005. Validate' process.

Element Name	Description	Special Type
BPE0027. A message or event notification from GUI is received for validation	Message input in the validation process.	Start
BPE0035. Validation completed successfully	The validation is completed successfully with no errors reported. The process terminates.	End
BPE0036. Validation completed with errors	The validation completed with errors. The process terminates.	End

2.7.3.3 Gateway(s)

The table below defines the 'Gateway(s)' of the 'BP0005. Validate' process.

Element Name	Description	Special Type
BPE0033. Merge Invalid Flows	Merge into exclusive event based gateway the invalid flows from all validation tasks.	Merge

CARM Customs Declaration and Excise Documents Processing system (CDEPS)	REF: CDEPS_EXPORT_BPS
Business Process Specifications for EXPORT System	VER:410

2.7.4.BP0246. Handle Pre-validation request

Business Process Description

The following table provides general information about the 'BP0246. Handle Pre-validation request' process. The Business Process Diagram and the description of various business process elements are specified in the following paragraphs.

Description	The process handles a request received from the Trader Portal for the pre-validation of any message. The process terminates with either a positive or negative reply back to the Trader Portal.
--------------------	---

Precondition(s)	
------------------------	--

Trigger	
----------------	--

Postcondition(s)	
-------------------------	--

Business Process Diagram

The Business Process Diagram of 'BP0246. Handle Pre-validation request' is shown below in BPMN notation. The definition of a process that might be used as sub-process by the 'BP0246. Handle Pre-validation request' can be found in this document. Finally, Annex A of CDEPS-BPS-EXPORT provides some explanatory information about the used notation.

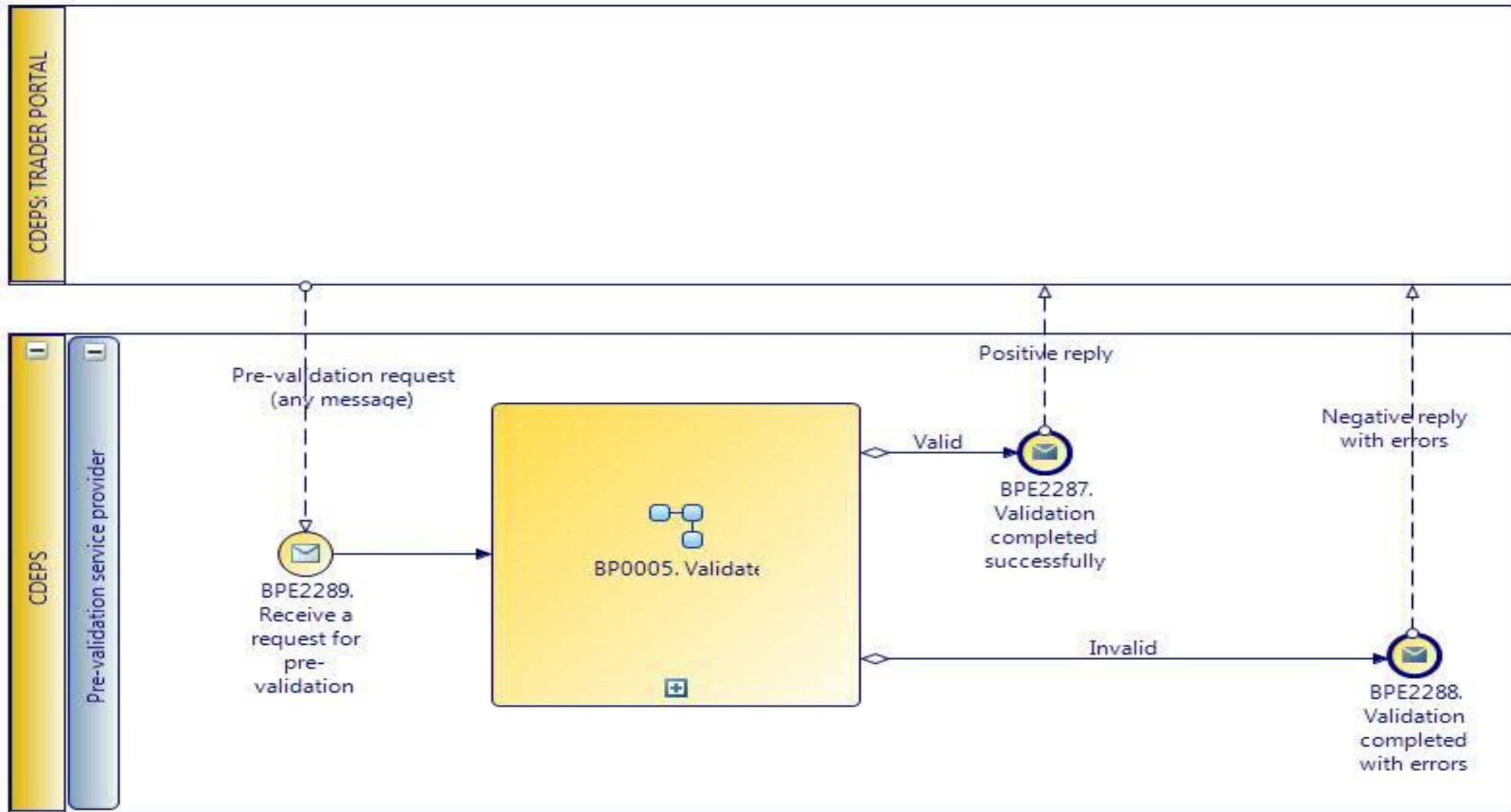

CARM Customs Declaration and Excise Documents Processing system (CDEPS)	REF: CDEPS_EXPORT_BPS
Business Process Specifications for EXPORT System	VER:410

2.7.4.1 Event(s)

The table below defines the 'Event(s)' of the 'BP0246. Handle Pre-validation request' process.

Element Name	Description	Special Type
BPE2287. Validation completed successfully	The validation is completed successfully with no errors reported. The process terminates and informs requesting system accordingly.	End
BPE2288. Validation completed with errors	The validation completed with errors. The process terminates and informs requesting system accordingly.	End
BPE2289. Receive a request for pre-validation	A pre-validation request is received from Trader Portal for a specific message.	Start

CARM Customs Declaration and Excise Documents Processing system (CDEPS)	REF: CDEPS_EXPORT_BPS
Business Process Specifications for EXPORT System	VER:410

2.8. Process Group: Export operation exit at Export

2.8.1.BP0142. Process Exit @ Office of Export

Business Process Description

The following table provides general information about the 'BP0142. Process Exit @ Office of Export' process. The Business Process Diagram and the description of various business process elements are specified in the following paragraphs.

Description	A high level process describing the actions performed by the system in order to process the exit of the movement at the Office of Export.
Precondition(s)	<ul style="list-style-type: none"> - Goods Released for Export - Under Exit Confirmation Request
Trigger	The process is triggered by the Exit Control results received from the Actual Office of Exit
Postcondition(s)	<ul style="list-style-type: none"> - None - Export Stopped, Discrepancies at Exit - Exported

Business Process Diagram

The Business Process Diagram of 'BP0142. Process Exit @ Office of Export' is shown below in BPMN notation. The definition of a process that might be used as sub-process by the 'BP0142. Process Exit @ Office of Export' can be found in this document. Finally, Annex A of CDEPS-BPS-EXPORT provides some explanatory information about the used notation.

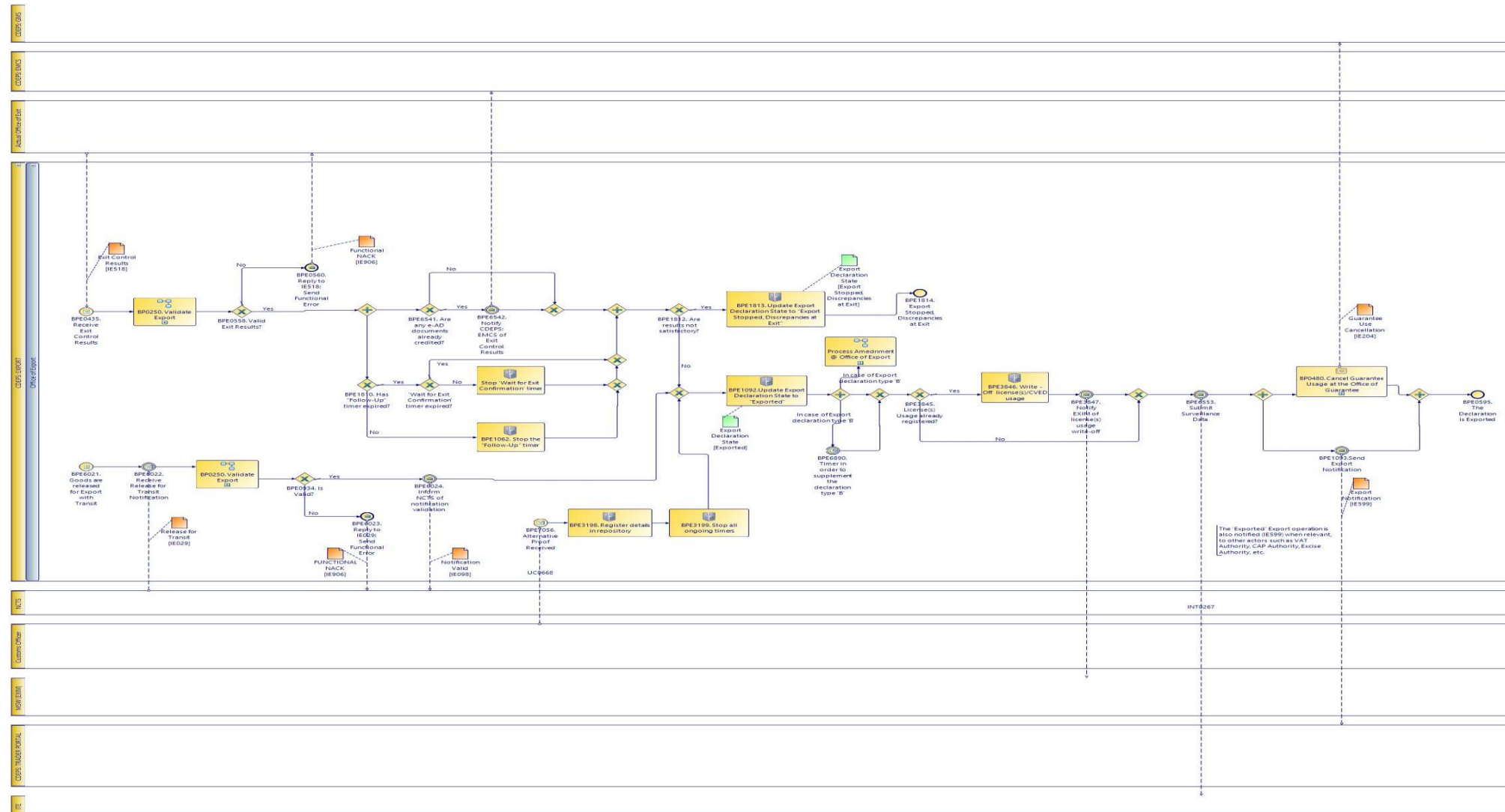

CARM Customs Declaration and Excise Documents Processing system (CDEPS)	REF: CDEPS_EXPORT_BPS
Business Process Specifications for EXPORT System	VER:410

2.8.1.1 Activities

The table below defines the 'Activities' of the 'BP0142. Process Exit @ Office of Export' process.

Element Name	Description	Special Type
BPE1062. Stop the "Follow-Up" timer	Upon the validation of the not satisfactory exit control results at the Office of Export the system stops the "Follow-Up" timer.	Service Task
BPE1092. Update Export Declaration State to 'Exported'	The system updates the Export Declaration State to 'Exported'	Service Task
BPE1813. Update Export Declaration State to "Export Stopped, Discrepancies at Exit"	The system updates the Export Declaration State to "Export Stopped, Discrepancies at Exit" due to the unsatisfactory control results received.	Service Task
BPE3198. Register details in repository	Details are registered	Service Task
BPE3199. Stop all ongoing timers	All timer's still running for this movement shall be terminated by the system.	Service Task
BPE3846. Write - Off license(s)/CVED usage	Write - Off license(s)/CVED usage	Service Task

2.8.1.2 Event(s)

The table below defines the 'Event(s)' of the 'BP0142. Process Exit @ Office of Export' process.

Element Name	Description	Special Type
BPE0435. Receive Exit Control Results	The system at the Office of Export receives the Exit Control Results from the Office of Exit.	Start
BPE0560. Reply to IE518: Send Functional Error	Send functional error in case of rejection	End
BPE0595. The Declaration is Exported	The Declaration is Exported and the process terminates	End

CARM Customs Declaration and Excise Documents Processing system (CDEPS)	REF: CDEPS_EXPORT_BPS
Business Process Specifications for EXPORT System	VER:410
BPE1093. Send Export Notification	The system sends the Export Notification to Trader End
BPE1814. Export Stopped, Discrepancies at Exit	The exit control results reported discrepancies and the process terminates End
BPE3847. Notify EXIM of license(s) usage write-off	Notify EXIM of license(s) usage write-off Intermediate
BPE6021. Goods are released for Export with Transit	The movement is under the state 'Goods Release for Export with Transit'. Start
BPE6022. Receive Release for Transit Notification	The system receives from NCTS the notification that the goods have been released for Transit. Intermediate
BPE6023. Reply to IE029: Send Functional Error	The system replies with a functional error the invalid IE029 received from NCTS Intermediate
BPE6024. Inform NCTS of notification validation	Intermediate
BPE6542. Notify CDEPS: EMCS of Exit Control Results	The system notifies CDEPS: EMCS of Exit Control Results Intermediate
BPE6553. Submit Surveillance Data	The system Submits the stored Surveillance Data to ITE. Intermediate
BPE6890. Timer in order to supplement the declaration type 'B'	Start timer in order to supplement the declaration type 'B', with the registration of type 'X'. Intermediate
↳ Business Rule 621	<i>Supplement 'X' Declaration Timer expiration</i>
BPE7056. Alternative Proof Received	Register Alternative Proof of the goods being released at Exit. Start

CARM Customs Declaration and Excise Documents Processing system (CDEPS)	REF: CDEPS_EXPORT_BPS
Business Process Specifications for EXPORT System	VER:410

2.8.1.3 Gateway(s)

The table below defines the 'Gateway(s)' of the 'BP0142. Process Exit @ Office of Export' process.

Element Name	Description	Special Type
BPE0558. Valid Exit Results?	Check whether the Exit Results validation shows any errors	Decision
BPE0934. Is Valid?	A decision point in the process to navigate the flow based on the message validation result.	Decision
↳ Business Rule 638	<i>Import declaration type 'X' cannot be cancelled</i>	
↳ Business Rule 646	<i>Guarantees during the registration of Import declaration type 'X'</i>	
↳ Business Rule 80	<i>Valid Message</i>	
BPE1810. Has "Follow-Up" timer expired?	A decision point in the process to navigate the flow based on whether the 'Follow-Up' timer has expired.	Decision
BPE1812. Are results not satisfactory?	A decision point in the process to navigate the flow based on whether the exit control results are satisfactory.	Decision
BPE3845. License(s) Usage already registered?	A decision point in the process to navigate the flow based on whether the usage of the licenses has been already registered or not	Decision
BPE6541. Are any e-AD documents already credited?	A decision point in the process to navigate the flow based on whether e-AD documents are already credited?	Decision

CARM Customs Declaration and Excise Documents Processing system (CDEPS)	REF: CDEPS_EXPORT_BPS
Business Process Specifications for EXPORT System	VER:410

2.8.2.BP0250. Validate Export

Business Process Description

The following table provides general information about the 'BP0250. Validate Export' process. The Business Process Diagram and the description of various business process elements are specified in the following paragraphs.

Description	Reusable subprocess that performs the message validation tasks for Export Regime.
Precondition(s)	None
Trigger	The process is triggered when an electronic message is received for validation.
Postcondition(s)	The validation is either completed successfully or with errors reported

Business Process Diagram

The Business Process Diagram of 'BP0250. Validate Export' is shown below in BPMN notation. The definition of a process that might be used as sub-process by the 'BP0250. Validate Export' can be found in this document. Finally, Annex A of CDEPS-BPS-EXPORT provides some explanatory information about the used notation.

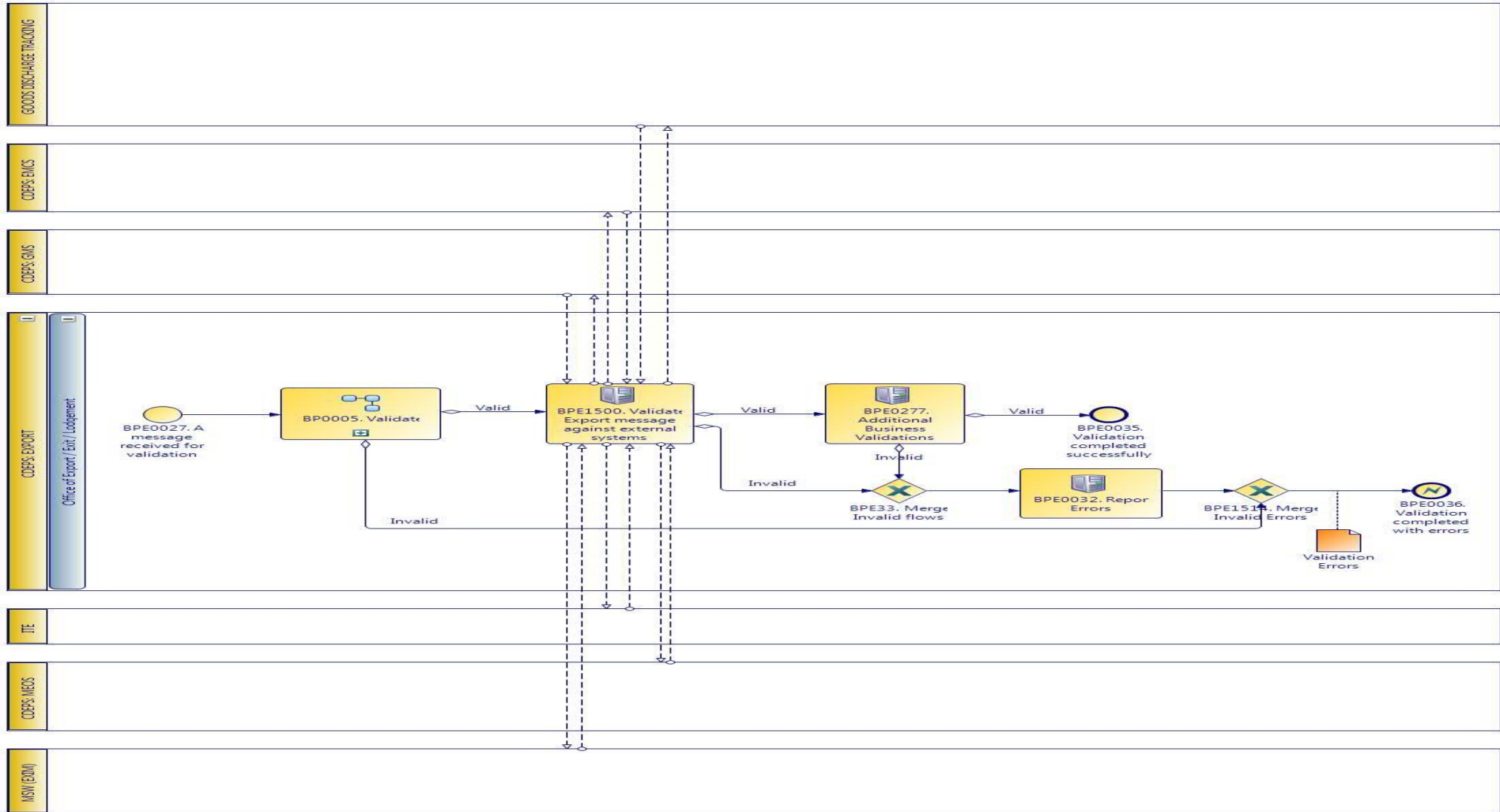

CARM Customs Declaration and Excise Documents Processing system (CDEPS)	REF: CDEPS_EXPORT_BPS
Business Process Specifications for EXPORT System	VER:410

2.8.2.1 Activities

The table below defines the 'Activities' of the 'BP0250. Validate Export' process.

Element Name	Description	Special Type
BPE0032. Report Errors	Report the identified errors from the validation process. The process terminates.	Service Task
BPE0277. Additional Business Validations for Export	The system performs any additional business validations specific to Export System.	Service Task
↳ Business Rule 19	Trader amending data same as Person lodging the declaration	
↳ Business Rule 21	Reject ENS/EXS amendment if ENS/EXS is not in appropriate state	
↳ Business Rule 245	Validate Personal ID	
↳ Business Rule 39	Cancellation Constraint	
↳ Business Rule 520	Import/ Export allowed guarantee types	
↳ Business Rule 70	EXS exists at the Office of Exit	
↳ Business Rule 71	Manifest number in IE547 and IE590	
BPE1500. Validate Export message against external systems	The system performs message validations against external systems.	Service Task
↳ Business Rule 101	Validate Economic Operator against MEOS	
↳ Business Rule 422	Validation of NCTS notifications	
↳ Business Rule 425	Goods Discharge required	
↳ Business Rule 439	Validate against GMS for integrity check	
↳ Business Rule 440	Validate Economic Operator's TIN against MEOS	
↳ Business Rule 494	Orchestrate validation of Export message against external systems	
↳ Business Rule 508	Validation of Export licenses with EXIM	

CARM Customs Declaration and Excise Documents Processing system (CDEPS)	REF: CDEPS_EXPORT_BPS
Business Process Specifications for EXPORT System	VER:410
↳ Business Rule 509	Check Export authorizations with MEOS
↳ Business Rule 51	Validate declared Combined Nomenclature in Declaration against ITE.
↳ Business Rule 510	Check Export authorizations for representation with MEOS
↳ Business Rule 511	Check Evidence of Power of Attorney with MEOS
↳ Business Rule 521	Validate Export declaration against ITE (duty calculation).
↳ Business Rule 522	Validate Export declaration data against Goods Discharge Tracking system
↳ Business Rule 527	Validate Export Declaration data against Excise system

2.8.2.2 Event(s)

The table below defines the 'Event(s)' of the 'BP0250. Validate Export' process.

Element Name	Description	Special Type
BPE0027. A message or event notification from GUI is received for validation	Message input in the validation process.	Start
BPE0035. Validation completed successfully	The validation is completed successfully with no errors reported. The process terminates.	End
BPE0036. Validation completed with errors	The validation completed with errors. The process terminates.	End

2.8.2.3 Gateway(s)

The table below defines the 'Gateway(s)' of the 'BP0250. Validate Export' process.

Element Name	Description	Special Type
BPE1514. Merge Invalid Errors	Combines exclusively either the negative outcome of generic validate process (BP0005. Validate) which reports errors or the errors from the extra checks for the specific system.	Merge

CARM Customs Declaration and Excise Documents Processing system (CDEPS)	REF: CDEPS_EXPORT_BPS
Business Process Specifications for EXPORT System	VER:410

2.8.3.BP0005. Validate

Business Process Description

The following table provides general information about the 'BP0005. Validate' process. The Business Process Diagram and the description of various business process elements are specified in the following paragraphs.

Description	Reusable subprocess that performs the message validation tasks
Precondition(s)	None
Trigger	The process is triggered when an electronic message is received for validation.
Postcondition(s)	

Business Process Diagram

The Business Process Diagram of 'BP0005. Validate' is shown below in BPMN notation. The definition of a process that might be used as sub-process by the 'BP0005. Validate' can be found in this document. Finally, Annex A of CDEPS-BPS-EXPORT provides some explanatory information about the used notation.

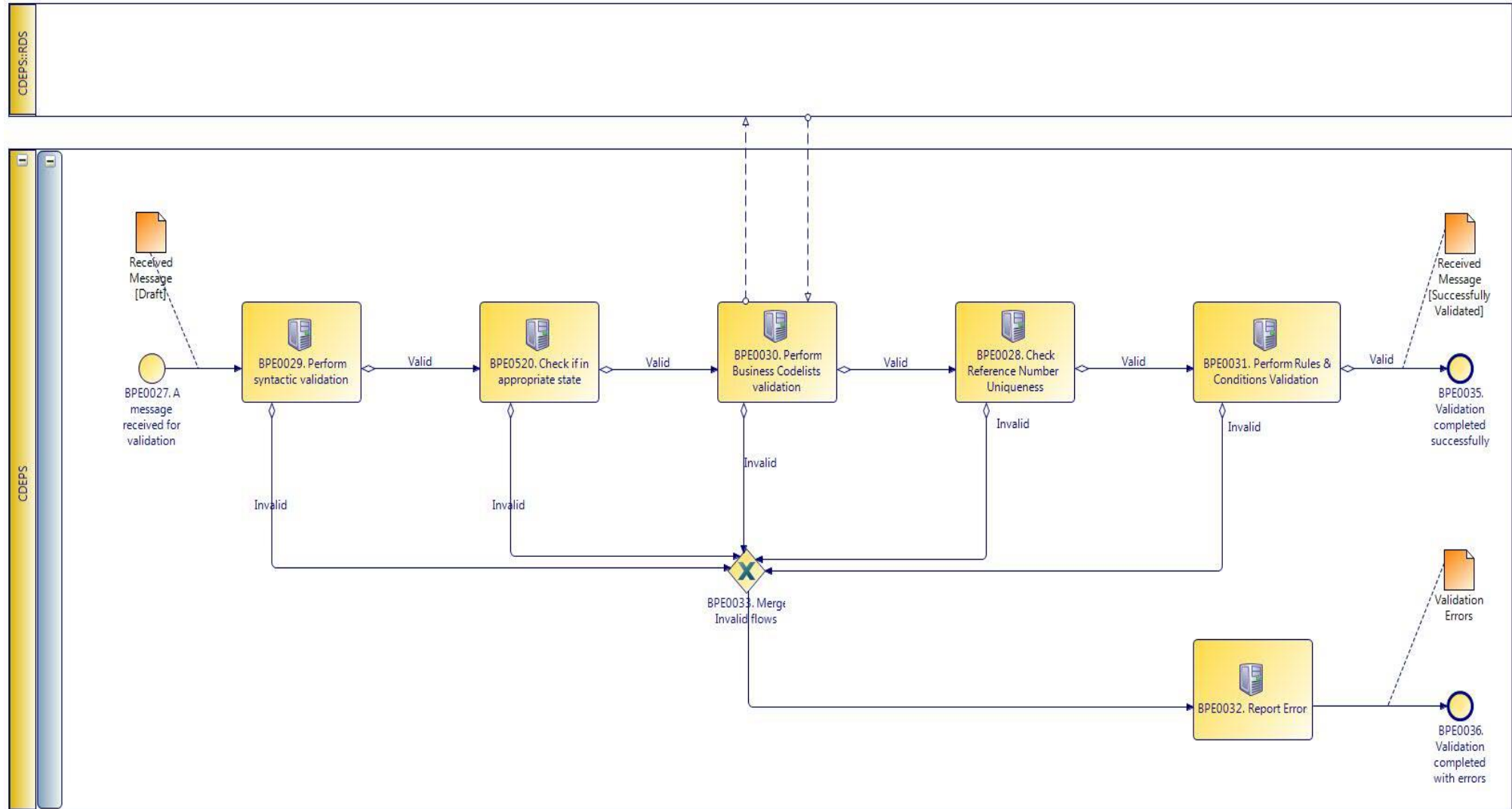

CARM Customs Declaration and Excise Documents Processing system (CDEPS)	REF: CDEPS_EXPORT_BPS
Business Process Specifications for EXPORT System	VER:410

2.8.3.1 Activities

The table below defines the 'Activities' of the 'BP0005. Validate' process.

Element Name	Description	Special Type
BPE0028. Check Reference Number Uniqueness	Check whether message reference numbers are unique in the system.	Service Task
↳ Business Rule 1	<i>Check Message Identification uniqueness</i>	
↳ Business Rule 74	<i>Check Local Reference Number (LRN) uniqueness</i>	
↳ Business Rule 75	<i>Check Movement Reference Number (MRN)uniqueness</i>	
↳ Business Rule 79	<i>Check Manifest reference number uniqueness</i>	
BPE0029. Perform syntactic validation	Check messages against the XSDs.	Service Task
↳ Business Rule 47	<i>Syntactic validation</i>	
BPE0030. Perform Business Codelists validation	Check the message business codelists.	Service Task
↳ Business Rule 50	<i>Business codelist validation against CDEPS:RDS</i>	
BPE0031. Perform Rules & Conditions Validation	Check the rules and conditions of the respective message.	Service Task
BPE0032. Report Errors	Report the identified errors from the validation process. The process terminates.	Service Task
BPE0520. Check if in appropriate state	Check whether the process for the particular entity (e.g. declaration/ application/ document) is on the appropriate state to process the received message. This check shall be performed based on the pertinent State Model of the system.	Service Task
↳ Business Rule 421	<i>Supplementary Declaration validation at Export</i>	
↳ Business Rule 448	<i>Check appropriate state for Export Declaration Amendment</i>	

CARM Customs Declaration and Excise Documents Processing system (CDEPS)	REF: CDEPS_EXPORT_BPS
Business Process Specifications for EXPORT System	VER:410

- ↳ **Business Rule** 449 *Check appropriate state Declaration Goods Presentation*
- ↳ **Business Rule** 468 *Guarantee Amendment*
- ↳ **Business Rule** 492 *Exit control results received at Export*
- ↳ **Business Rule** 493 *Export Declaration request at Export*

2.8.3.2 Event(s)

The table below defines the 'Event(s)' of the 'BP0005. Validate' process.

Element Name	Description	Special Type
BPE0027. A message or event notification from GUI is received for validation	Message input in the validation process.	Start
BPE0035. Validation completed successfully	The validation is completed successfully with no errors reported. The process terminates.	End
BPE0036. Validation completed with errors	The validation completed with errors. The process terminates.	End

2.8.3.3 Gateway(s)

The table below defines the 'Gateway(s)' of the 'BP0005. Validate' process.

Element Name	Description	Special Type
BPE0033. Merge Invalid Flows	Merge into exclusive event based gateway the invalid flows from all validation tasks.	Merge

CARM Customs Declaration and Excise Documents Processing system (CDEPS)	REF: CDEPS_EXPORT_BPS
Business Process Specifications for EXPORT System	VER:410

2.8.4.BP0246. Handle Pre-validation request

Business Process Description

The following table provides general information about the 'BP0246. Handle Pre-validation request' process. The Business Process Diagram and the description of various business process elements are specified in the following paragraphs.

Description	The process handles a request received from the Trader Portal for the pre-validation of any message. The process terminates with either a positive or negative reply back to the Trader Portal.
Precondition(s)	
Trigger	
Postcondition(s)	

Business Process Diagram

The Business Process Diagram of 'BP0246. Handle Pre-validation request' is shown below in BPMN notation. The definition of a process that might be used as sub-process by the 'BP0246. Handle Pre-validation request' can be found in this document. Finally, Annex A of CDEPS-BPS-EXPORT provides some explanatory information about the used notation.

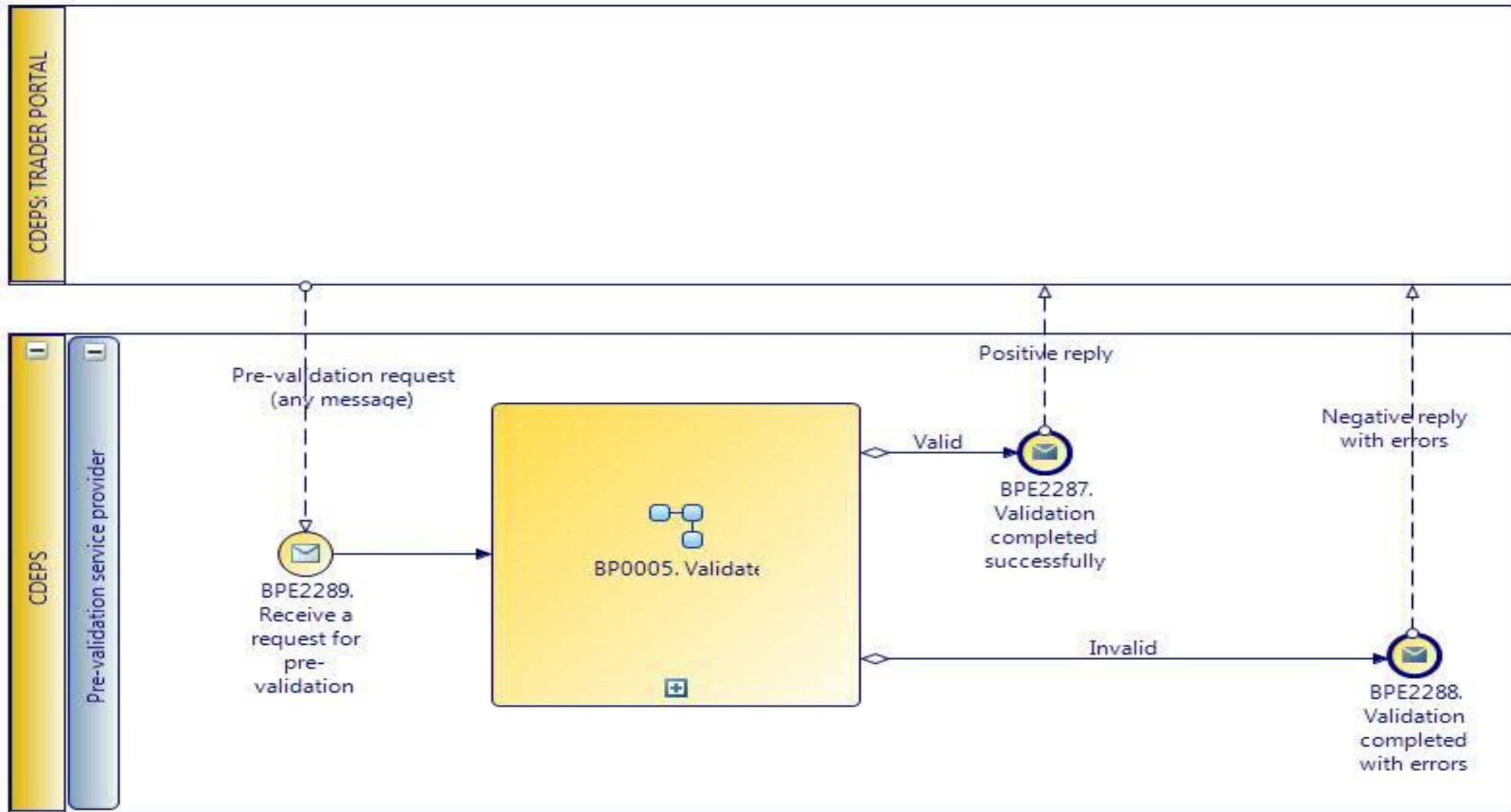

CARM Customs Declaration and Excise Documents Processing system (CDEPS)	REF: CDEPS_EXPORT_BPS
Business Process Specifications for EXPORT System	VER:410

2.8.4.1 Event(s)

The table below defines the 'Event(s)' of the 'BP0246. Handle Pre-validation request' process.

Element Name	Description	Special Type
BPE2287. Validation completed successfully	The validation is completed successfully with no errors reported. The process terminates and informs requesting system accordingly.	End
BPE2288. Validation completed with errors	The validation completed with errors. The process terminates and informs requesting system accordingly.	End
BPE2289. Receive a request for pre-validation	A pre-validation request is received from Trader Portal for a specific message.	Start

CARM Customs Declaration and Excise Documents Processing system (CDEPS)	REF: CDEPS_EXPORT_BPS
Business Process Specifications for EXPORT System	VER:410

2.9. Process Group: Export operation Amendment at Export

2.9.1.BP0150. Process Amendment @ Office of Export

Business Process Description

The following table provides general information about the 'BP0150. Process Amendment @ Office of Export' process. The Business Process Diagram and the description of various business process elements are specified in the following paragraphs.

Description	A high level process describing the actions performed by the system in order to handle an amendment request received electronically from the Trader or on paper at the Office of Export.
Precondition(s)	<ul style="list-style-type: none"> - Waiting for Control Decision - Registering Guarantee Amounts - Under Release - Declaration Under Amendment - Guarantee Under Amendment
Trigger	The process is triggered when a declaration amendment is requested, either via an electronic message or on paper at the Office of Export.
Postcondition(s)	<ul style="list-style-type: none"> - None - Registering Guarantee Amounts - Guarantee Under Registration

Business Process Diagram

The Business Process Diagram of 'BP0150. Process Amendment @ Office of Export' is shown below in BPMN notation. The definition of a process that might be used as sub-process by the 'BP0150. Process Amendment @ Office of Export' can be found in this document. Finally, Annex A of CDEPS-BPS-EXPORT provides some explanatory information about the used notation.

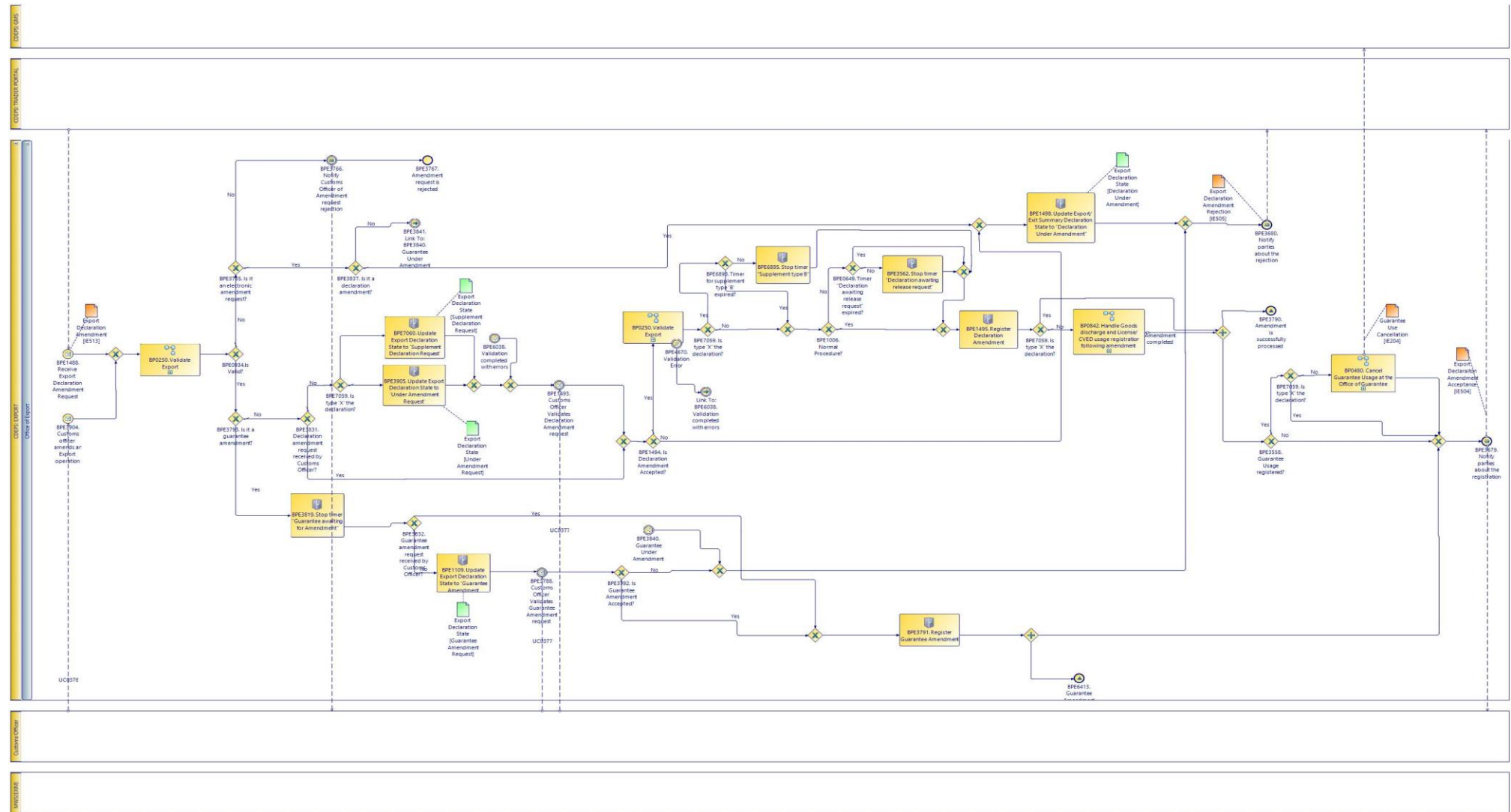

CARM Customs Declaration and Excise Documents Processing system (CDEPS)	REF: CDEPS_EXPORT_BPS
Business Process Specifications for EXPORT System	VER:410

2.9.1.1 Activities

The table below defines the 'Activities' of the 'BP0150. Process Amendment @ Office of Export' process.

Element Name	Description	Special Type
BPE1109. Update Export Declaration State to 'Guarantee Amendment Request'	The system updates the Export Declaration State to 'Guarantee Amendment Request'	Service Task
BPE1495. Register Declaration Amendment	Upon its successful validation the declaration amendment request is registered in the system	Service Task
BPE1498. Update Export/Exit Summary Declaration State to "Declaration Under Amendment"	The system updates the Export/Exit Summary Declaration State to "Declaration Under Amendment" upon the rejection of the declaration amendment request	Service Task
BPE3562. Stop timer "Declaration awaiting release request"	The timer "Declaration awaiting release request" stops due to the Declaration Amendment	Service Task
↳ Business Rule	132	Stop timer
↳ Business Rule	186	Start / End day of Timers
BPE3791. Register Guarantee Amendment	The system registers the Guarantee Amendment upon its acceptance by the Customs Officer	Service Task
BPE3819. Stop timer "Guarantee awaiting for Amendment"	The timer stops upon the reception of the amendment request or cancellation of the movement.	Service Task
↳ Business Rule	132	Stop timer
↳ Business Rule	186	Start / End day of Timers

CARM Customs Declaration and Excise Documents Processing system (CDEPS)	REF: CDEPS_EXPORT_BPS
Business Process Specifications for EXPORT System	VER:410
BPE3905. Update Export/Exit Summary Declaration State to 'Under Amendment Request'	The system updates the state of the Export/Exit Summary Declaration to 'Under Amendment Request' Service Task
BPE6895. Stop timer "Supplement type B"	Stop the timer "Supplement type B". Service Task
BPE7060. Update Export Declaration State to 'Supplement Declaration Request'	The system updates the Export Declaration State to 'Supplement Declaration Request'. Service Task

2.9.1.2 Event(s)

The table below defines the 'Event(s)' of the 'BP0150. Process Amendment @ Office of Export' process.

Element Name	Description	Special Type
BPE1488. Receive Export Declaration Amendment Request	The process is triggered when the Office of Export receives an export declaration amendment request by the Trader	Start
BPE1493. Customs Officer Validates Declaration Amendment request	The Customs Officer validates the amendment request and the flow continues.	Intermediate
BPE3679. Notify parties about the registration	Upon the validation of the Declaration data the parties are notified of the successful registration	Intermediate
BPE3680. Notify parties about the rejection	Upon the invalidation of the Declaration data the parties are notified of the rejection	Intermediate
BPE3766. Notify Customs Officer of Amendment request rejection	Notify Customs Officer of Amendment request rejection	Intermediate

CARM Customs Declaration and Excise Documents Processing system (CDEPS)	REF: CDEPS_EXPORT_BPS
Business Process Specifications for EXPORT System	VER:410
BPE3767. Amendment request is rejected	Amendment request is rejected End
BPE3788. Customs Officer Validates Guarantee Amendment request	The Customs Officer validates the amendment request and the flow continues. Intermediate
BPE3790. Amendment is successfully processed	The Amendment is successfully processed End
BPE3840. Guarantee Under Amendment	A catch link in the process triggered when the Guarantee is under amendment Intermediate
BPE3841. Guarantee Amendment processed	The Guarantee Amendment is processed End
BPE3904. Customs officer amends an Export operation	Customs officer amends an Export operation Start
BPE6038. Validation completed with errors	A throw link in the process navigating the flow when the validation errors are reported Intermediate
BPE6039. Link To: BPE6038. Validation completed with errors	An intermediate event in the process linked to: BPE6038. Validation completed with errors Intermediate
BPE6413. Guarantee Amendment successfully processed	Guarantee Amendment successfully processed End

CARM Customs Declaration and Excise Documents Processing system (CDEPS)	REF: CDEPS_EXPORT_BPS
Business Process Specifications for EXPORT System	VER:410

2.9.1.3 Gateway(s)

The table below defines the 'Gateway(s)' of the 'BP0150. Process Amendment @ Office of Export' process.

Element Name	Description	Special Type
BPE0649. Timer "Declaration awaiting release request" expired?	A decision point in the process to split the flow depending on whether the "Declaration awaiting release request" has expired.	Decision
BPE0934. Is Valid?	A decision point in the process to navigate the flow based on the message validation result.	Decision
↳ Business Rule	638 <i>Import declaration type 'X' cannot be cancelled</i>	
↳ Business Rule	646 <i>Guarantees during the registration of Import declaration type 'X'</i>	
↳ Business Rule	80 <i>Valid Message</i>	
BPE1006. Normal Procedure?	A decision point in the process to split the flow based on whether it is a normal or simplified procedure.	Decision
↳ Business Rule	386 <i>Normal Procedure Declaration</i>	
BPE1494. Is Declaration Amendment Accepted?	A decision point in the process to split the flow based on the validation results of the amendment request performed by the Customs Officer	Decision
BPE3558. Guarantee Usage registered?	A decision point in the process to navigate the flow based on whether the guarantee usage has been registered	Decision
BPE3765. Is it an electronic amendment request?	A decision point in the flow to navigate the process based on whether the amendment request is electronic or not	Decision
BPE3792. Is Guarantee Amendment Accepted?	A decision point in the process to navigate the flow based on whether the Guarantee Amendment has been accepted or not.	Decision
BPE3793. Is it a guarantee amendment?	A decision point in the process to navigate the flow based on whether the amendment request received refers to the declaration or the guarantee data.	Decision

CARM Customs Declaration and Excise Documents Processing system (CDEPS)	REF: CDEPS_EXPORT_BPS
Business Process Specifications for EXPORT System	VER:410
BPE3831. Declaration amendment request received by Customs Officer?	A decision point in the process to navigate the flow based on whether the Declaration amendment request was received by the Customs Officer or not Decision
BPE3832. Guarantee amendment request received by Customs Officer?	A decision point in the process to navigate the flow based on whether the Guarantee amendment request was received by the Customs Officer or not Decision
BPE3837. Is it a declaration amendment?	A decision point in the process to navigate the flow based on whether it is a declaration amendment or not Decision
BPE6893. Timer for supplement type 'B' expired?	Timer for supplement type 'B' expired? Decision
BPE7059. Is type 'X' the Export declaration?	Decision

CARM Customs Declaration and Excise Documents Processing system (CDEPS)	REF: CDEPS_EXPORT_BPS
Business Process Specifications for EXPORT System	VER:410

2.9.2.BP0250. Validate Export

Business Process Description

The following table provides general information about the 'BP0250. Validate Export' process. The Business Process Diagram and the description of various business process elements are specified in the following paragraphs.

Description	Reusable subprocess that performs the message validation tasks for Export Regime.
Precondition(s)	None
Trigger	The process is triggered when an electronic message is received for validation.
Postcondition(s)	The validation is either completed successfully or with errors reported

Business Process Diagram

The Business Process Diagram of 'BP0250. Validate Export' is shown below in BPMN notation. The definition of a process that might be used as sub-process by the 'BP0250. Validate Export' can be found in this document. Finally, Annex A of CDEPS-BPS-EXPORT provides some explanatory information about the used notation.

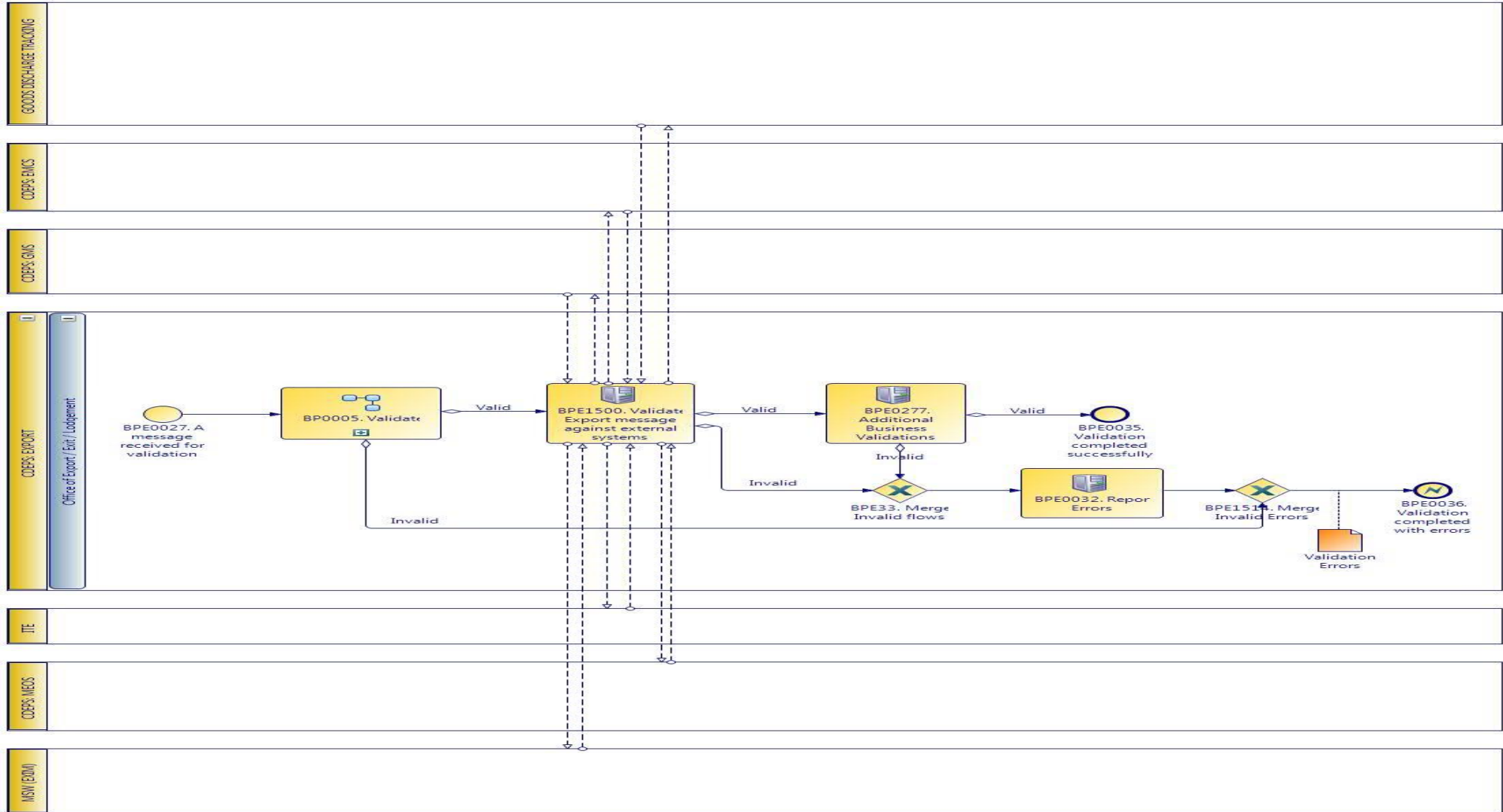

CARM Customs Declaration and Excise Documents Processing system (CDEPS)	REF: CDEPS_EXPORT_BPS
Business Process Specifications for EXPORT System	VER:410

2.9.2.1 Activities

The table below defines the 'Activities' of the 'BP0250. Validate Export' process.

Element Name	Description	Special Type
BPE0032. Report Errors	Report the identified errors from the validation process. The process terminates.	Service Task
BPE0277. Additional Business Validations for Export	The system performs any additional business validations specific to Export System.	Service Task
↳ Business Rule 19	Trader amending data same as Person lodging the declaration	
↳ Business Rule 21	Reject ENS/EXS amendment if ENS/EXS is not in appropriate state	
↳ Business Rule 245	Validate Personal ID	
↳ Business Rule 39	Cancellation Constraint	
↳ Business Rule 520	Import/ Export allowed guarantee types	
↳ Business Rule 70	EXS exists at the Office of Exit	
↳ Business Rule 71	Manifest number in IE547 and IE590	
BPE1500. Validate Export message against external systems	The system performs message validations against external systems.	Service Task
↳ Business Rule 101	Validate Economic Operator against MEOS	
↳ Business Rule 422	Validation of NCTS notifications	
↳ Business Rule 425	Goods Discharge required	
↳ Business Rule 439	Validate against GMS for integrity check	
↳ Business Rule 440	Validate Economic Operator's TIN against MEOS	
↳ Business Rule 494	Orchestrate validation of Export message against external systems	
↳ Business Rule 508	Validation of Export licenses with EXIM	

CARM Customs Declaration and Excise Documents Processing system (CDEPS)	REF: CDEPS_EXPORT_BPS
Business Process Specifications for EXPORT System	VER:410
↳ Business Rule 509	Check Export authorizations with MEOS
↳ Business Rule 51	Validate declared Combined Nomenclature in Declaration against ITE.
↳ Business Rule 510	Check Export authorizations for representation with MEOS
↳ Business Rule 511	Check Evidence of Power of Attorney with MEOS
↳ Business Rule 521	Validate Export declaration against ITE (duty calculation).
↳ Business Rule 522	Validate Export declaration data against Goods Discharge Tracking system
↳ Business Rule 527	Validate Export Declaration data against Excise system

2.9.2.2 Event(s)

The table below defines the 'Event(s)' of the 'BP0250. Validate Export' process.

Element Name	Description	Special Type
BPE0027. A message or event notification from GUI is received for validation	Message input in the validation process.	Start
BPE0035. Validation completed successfully	The validation is completed successfully with no errors reported. The process terminates.	End
BPE0036. Validation completed with errors	The validation completed with errors. The process terminates.	End

2.9.2.3 Gateway(s)

The table below defines the 'Gateway(s)' of the 'BP0250. Validate Export' process.

Element Name	Description	Special Type
BPE1514. Merge Invalid Errors	Combines exclusively either the negative outcome of generic validate process (BP0005. Validate) which reports errors or the errors from the extra checks for the specific system.	Merge

CARM Customs Declaration and Excise Documents Processing system (CDEPS)	REF: CDEPS_EXPORT_BPS
Business Process Specifications for EXPORT System	VER:410

2.9.3.BP0480. Cancel Guarantee Usage at the Office of Guarantee

Business Process Description

The following table provides general information about the 'BP0480. Cancel Guarantee Usage at the Office of Guarantee' process. The Business Process Diagram and the description of various business process elements are specified in the following paragraphs.

Description	Reusable subprocess that describes the tasks performed by the system in order to cancel the usage of the selected guarantee due to movement's cancellation/amendment
Precondition(s)	The Guarantee usage to be cancelled due to movement's cancellation/amendment are selected
Trigger	The process starts when the Guarantee usage to be cancelled due to movement's cancellation/amendment are selected
Postcondition(s)	The guarantee usage is cancelled

Business Process Diagram

The Business Process Diagram of 'BP0480. Cancel Guarantee Usage at the Office of Guarantee' is shown below in BPMN notation. The definition of a process that might be used as sub-process by the 'BP0480. Cancel Guarantee Usage at the Office of Guarantee' can be found in this document. Finally, Annex A of CDEPS-BPS-EXPORT provides some explanatory information about the used notation.

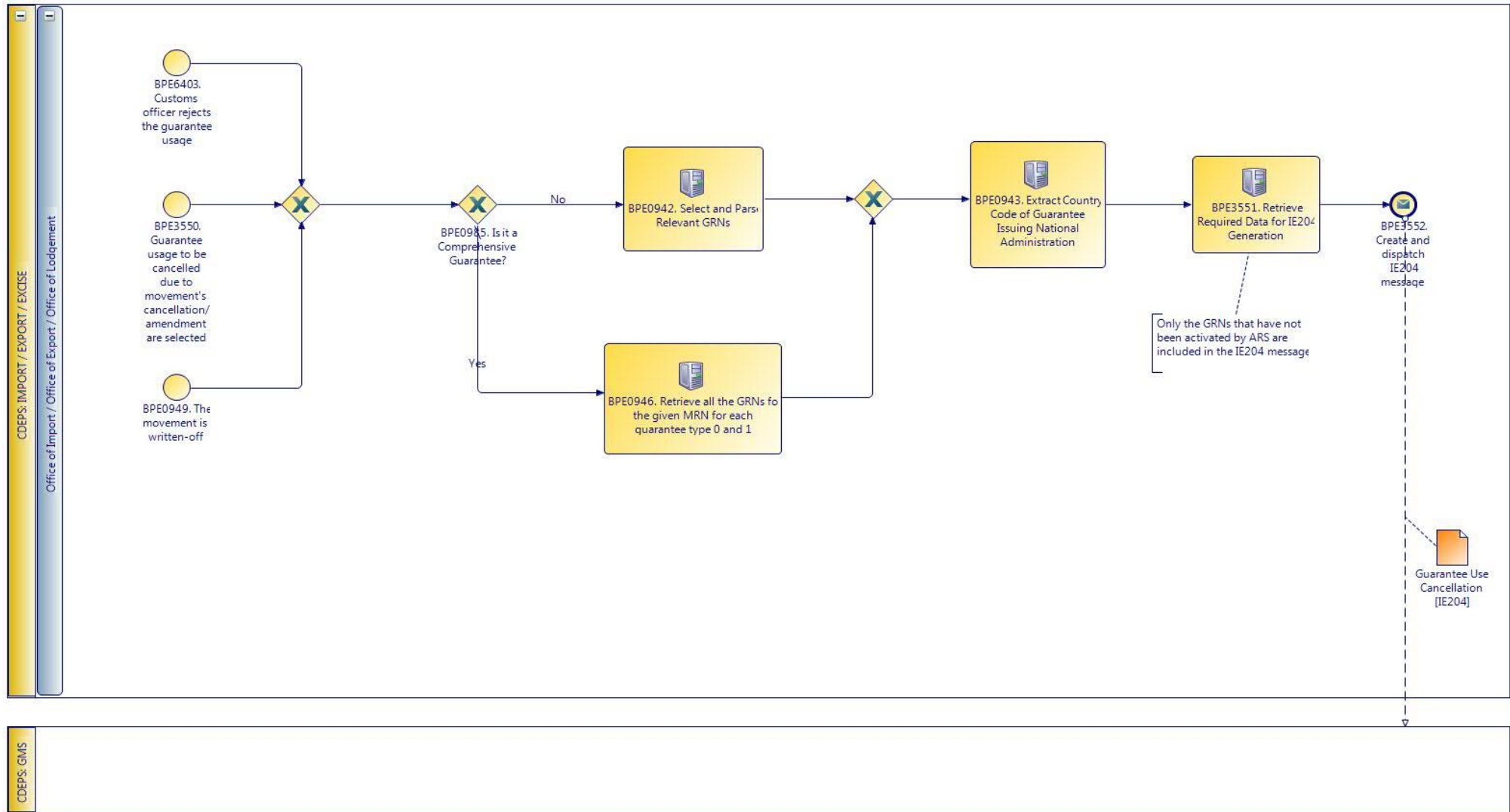

CARM Customs Declaration and Excise Documents Processing system (CDEPS)	REF: CDEPS_EXPORT_BPS
Business Process Specifications for EXPORT System	VER:410

2.9.3.1 Activities

The table below defines the 'Activities' of the 'BP0480. Cancel Guarantee Usage at the Office of Guarantee' process.

Element Name	Description	Special Type
BPE0942. Select and Parse Relevant GRNs	Select and Parse Relevant GRNs	Service Task
BPE0943. Extract Country Code of Guarantee Issuing National Administration	Extract Country Code of Guarantee Issuing National Administration	Service Task
BPE0946. Retrieve all the GRNs for the given MRN for each guarantee type 0 and 1	Retrieve all the GRNs for the given MRN for each guarantee type 0 and 1	Service Task
BPE3551. Retrieve Required Data for IE204 Generation	Retrieve Required Data for IE204 Generation	Service Task
↳ Business Rule 555	<i>Required data for IE204 generation</i>	

2.9.3.2 Event(s)

The table below defines the 'Event(s)' of the 'BP0480. Cancel Guarantee Usage at the Office of Guarantee' process.

Element Name	Description	Special Type
BPE0949. The movement is written-off	The movement is written-off	Start
BPE3550. Guarantee usage to be cancelled due to movement's cancellation/amendment are selected	Guarantee usage to be cancelled due to movement's cancellation/amendment are selected	Start

CARM Customs Declaration and Excise Documents Processing system (CDEPS)	REF: CDEPS_EXPORT_BPS
Business Process Specifications for EXPORT System	VER:410

BPE3552. Create and dispatch IE204 message	Create and dispatch IE204 message	End
BPE6403. Customs officer rejects the guarantee usage	Customs officer rejects the guarantee usage	Start

2.9.3.3 Gateway(s)

The table below defines the 'Gateway(s)' of the 'BP0480. Cancel Guarantee Usage at the Office of Guarantee' process.

Element Name	Description	Special Type
BPE0985. Is it a Comprehensive Guarantee?	A decision point in the process to navigate the flow based on the Guarantee type	Decision

CARM Customs Declaration and Excise Documents Processing system (CDEPS)	REF: CDEPS_EXPORT_BPS
Business Process Specifications for EXPORT System	VER:410

2.9.4.BP0005. Validate

Business Process Description

The following table provides general information about the 'BP0005. Validate' process. The Business Process Diagram and the description of various business process elements are specified in the following paragraphs.

Description	Reusable subprocess that performs the message validation tasks
Precondition(s)	None
Trigger	The process is triggered when an electronic message is received for validation.
Postcondition(s)	

Business Process Diagram

The Business Process Diagram of 'BP0005. Validate' is shown below in BPMN notation. The definition of a process that might be used as sub-process by the 'BP0005. Validate' can be found in this document. Finally, Annex A of CDEPS-BPS-EXPORT provides some explanatory information about the used notation.

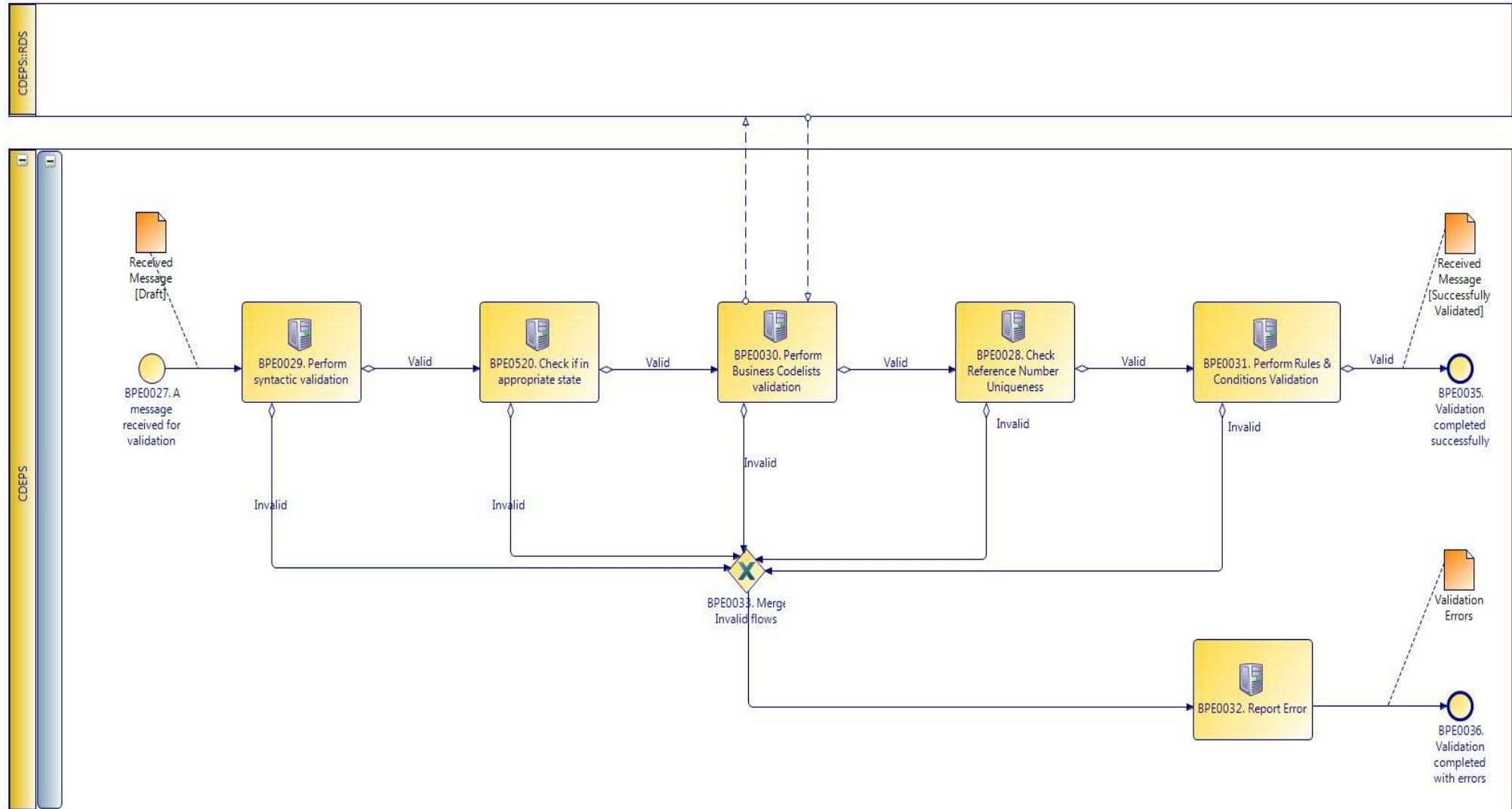

CARM Customs Declaration and Excise Documents Processing system (CDEPS)	REF: CDEPS_EXPORT_BPS
Business Process Specifications for EXPORT System	VER:410

2.9.4.1 Activities

The table below defines the 'Activities' of the 'BP0005. Validate' process.

Element Name	Description	Special Type
BPE0028. Check Reference Number Uniqueness	Check whether message reference numbers are unique in the system.	Service Task
↳ Business Rule 1	<i>Check Message Identification uniqueness</i>	
↳ Business Rule 74	<i>Check Local Reference Number (LRN) uniqueness</i>	
↳ Business Rule 75	<i>Check Movement Reference Number (MRN)uniqueness</i>	
↳ Business Rule 79	<i>Check Manifest reference number uniqueness</i>	
BPE0029. Perform syntactic validation	Check messages against the XSDs.	Service Task
↳ Business Rule 47	<i>Syntactic validation</i>	
BPE0030. Perform Business Codelists validation	Check the message business codelists.	Service Task
↳ Business Rule 50	<i>Business codelist validation against CDEPS:RDS</i>	
BPE0031. Perform Rules & Conditions Validation	Check the rules and conditions of the respective message.	Service Task
BPE0032. Report Errors	Report the identified errors from the validation process. The process terminates.	Service Task
BPE0520. Check if in appropriate state	Check whether the process for the particular entity (e.g. declaration/ application/ document) is on the appropriate state to process the received message. This check shall be performed based on the pertinent State Model of the system.	Service Task
↳ Business Rule 421	<i>Supplementary Declaration validation at Export</i>	
↳ Business Rule 448	<i>Check appropriate state for Export Declaration Amendment</i>	

CARM Customs Declaration and Excise Documents Processing system (CDEPS)	REF: CDEPS_EXPORT_BPS
Business Process Specifications for EXPORT System	VER:410

- ↳ **Business Rule** 449 *Check appropriate state Declaration Goods Presentation*
- ↳ **Business Rule** 468 *Guarantee Amendment*
- ↳ **Business Rule** 492 *Exit control results received at Export*
- ↳ **Business Rule** 493 *Export Declaration request at Export*

2.9.4.2 Event(s)

The table below defines the 'Event(s)' of the 'BP0005. Validate' process.

Element Name	Description	Special Type
BPE0027. A message or event notification from GUI is received for validation	Message input in the validation process.	Start
BPE0035. Validation completed successfully	The validation is completed successfully with no errors reported. The process terminates.	End
BPE0036. Validation completed with errors	The validation completed with errors. The process terminates.	End

2.9.4.3 Gateway(s)

The table below defines the 'Gateway(s)' of the 'BP0005. Validate' process.

Element Name	Description	Special Type
BPE0033. Merge Invalid Flows	Merge into exclusive event based gateway the invalid flows from all validation tasks.	Merge

CARM Customs Declaration and Excise Documents Processing system (CDEPS)	REF: CDEPS_EXPORT_BPS
Business Process Specifications for EXPORT System	VER:410

2.9.5.BP0246. Handle Pre-validation request

Business Process Description

The following table provides general information about the 'BP0246. Handle Pre-validation request' process. The Business Process Diagram and the description of various business process elements are specified in the following paragraphs.

Description	The process handles a request received from the Trader Portal for the pre-validation of any message. The process terminates with either a positive or negative reply back to the Trader Portal.
Precondition(s)	
Trigger	
Postcondition(s)	

Business Process Diagram

The Business Process Diagram of 'BP0246. Handle Pre-validation request' is shown below in BPMN notation. The definition of a process that might be used as sub-process by the 'BP0246. Handle Pre-validation request' can be found in this document. Finally, Annex A of CDEPS-BPS-EXPORT provides some explanatory information about the used notation.

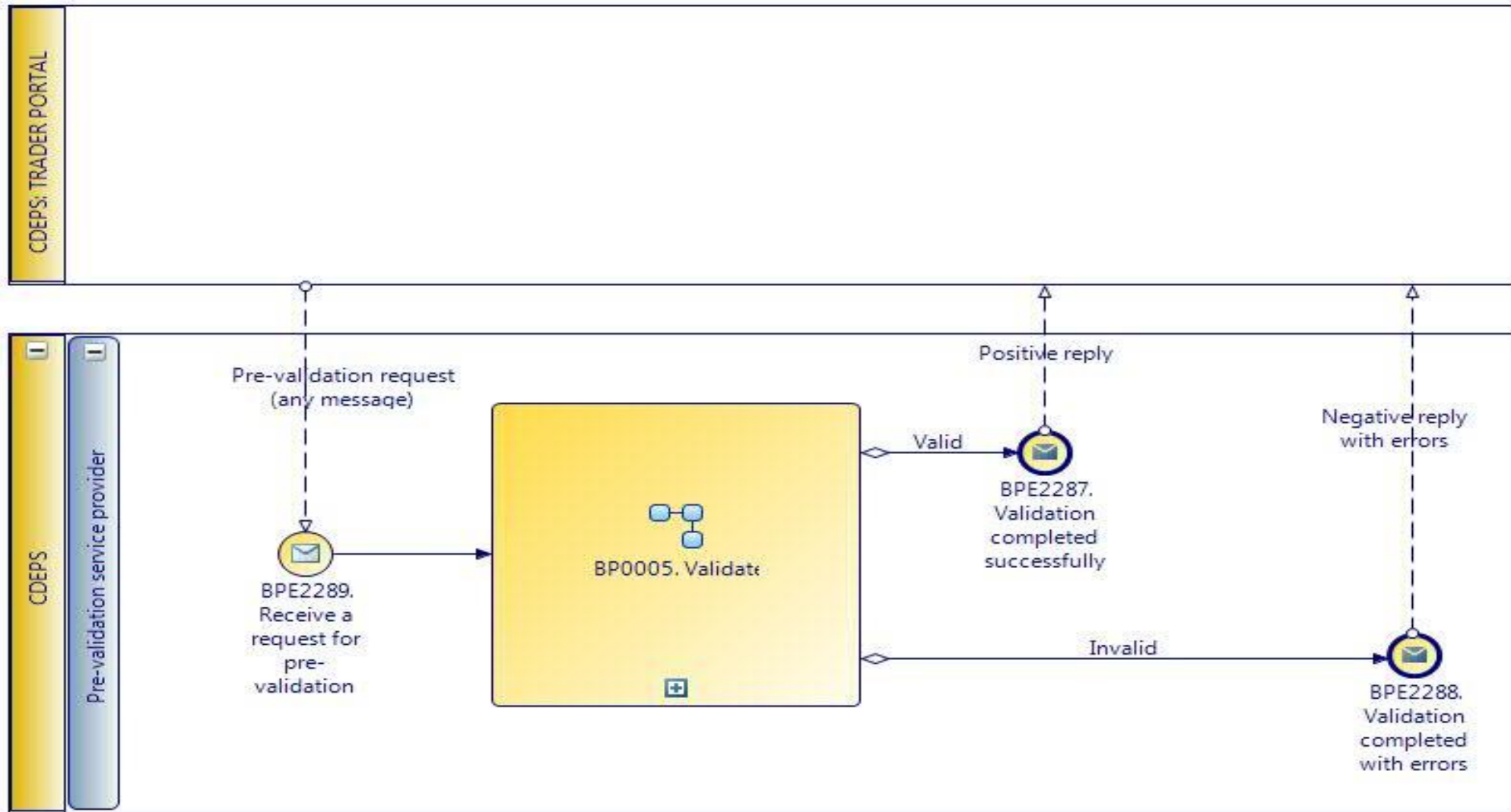

CARM Customs Declaration and Excise Documents Processing system (CDEPS)	REF: CDEPS_EXPORT_BPS
Business Process Specifications for EXPORT System	VER:410

2.9.5.1 Event(s)

The table below defines the 'Event(s)' of the 'BP0246. Handle Pre-validation request' process.

Element Name	Description	Special Type
BPE2287. Validation completed successfully	The validation is completed successfully with no errors reported. The process terminates and informs requesting system accordingly.	End
BPE2288. Validation completed with errors	The validation completed with errors. The process terminates and informs requesting system accordingly.	End
BPE2289. Receive a request for pre-validation	A pre-validation request is received from Trader Portal for a specific message.	Start

CARM Customs Declaration and Excise Documents Processing system (CDEPS)	REF: CDEPS_EXPORT_BPS
Business Process Specifications for EXPORT System	VER:410

2.9.6.BP0842. Handle Goods discharge and License/CVED usage registration following amendment

Business Process Description

The following table provides general information about the 'BP0842. Handle Goods discharge and License/CVED usage registration following amendment' process. The Business Process Diagram and the description of various business process elements are specified in the following paragraphs.

Description	The process handles the amendment of an already registered goods discharge and the cancellation of an registered License/CVED usage.
Precondition(s)	The declaration is already accepted and the Goods discharge and/or license usage has been registered
Trigger	Manual amendment from the Customs Officer or electronically by the Trader
Postcondition(s)	The Goods discharge and/or license usage is re-registered

Business Process Diagram

The Business Process Diagram of 'BP0842. Handle Goods discharge and License/CVED usage registration following amendment' is shown below in BPMN notation. The definition of a process that might be used as sub-process by the 'BP0842. Handle Goods discharge and License/CVED usage registration following amendment' can be found in this document. Finally, Annex A of CDEPS-BPS-EXPORT provides some explanatory information about the used notation.

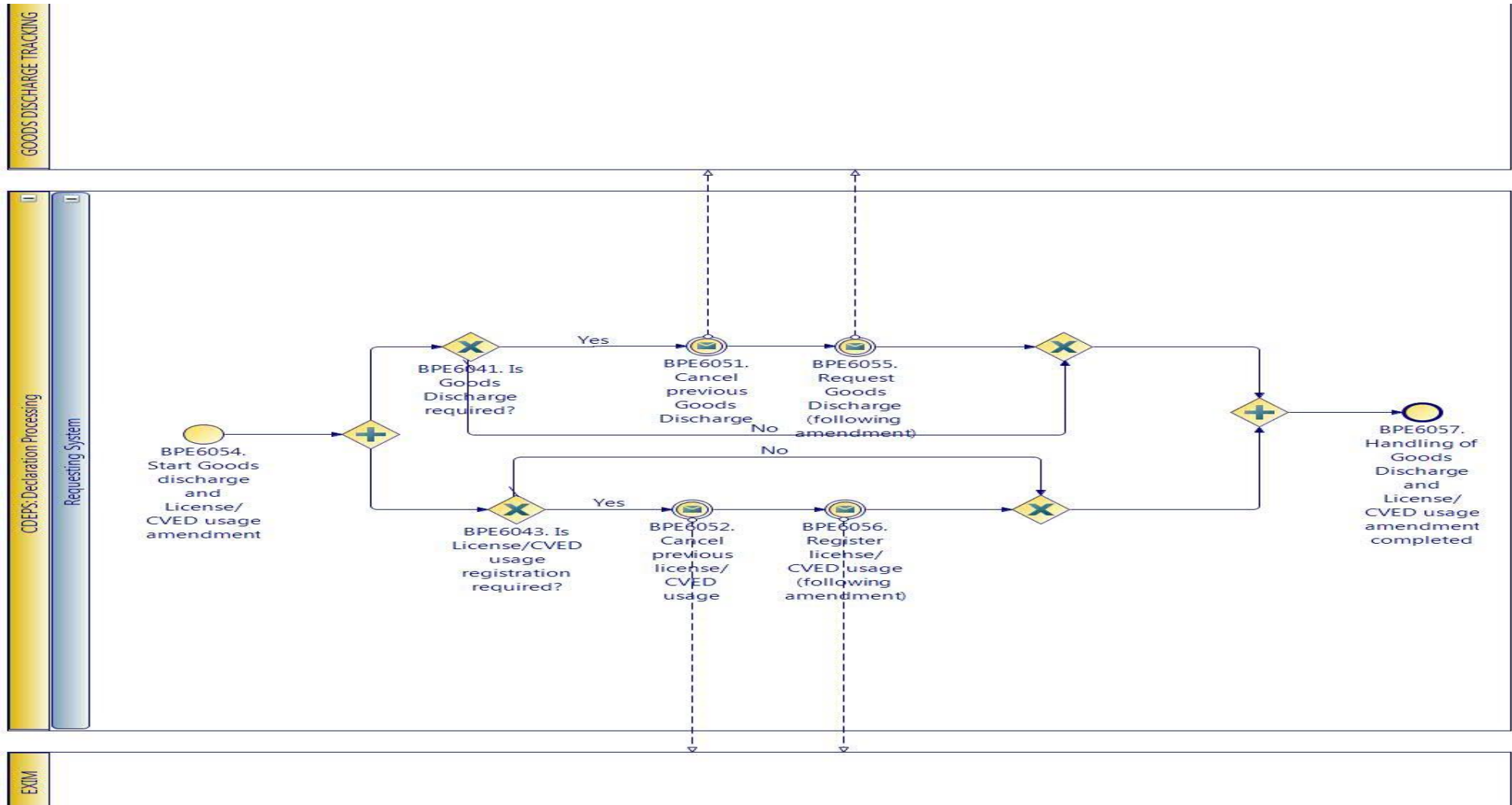

CARM Customs Declaration and Excise Documents Processing system (CDEPS)	REF: CDEPS_EXPORT_BPS
Business Process Specifications for EXPORT System	VER:410

2.9.6.1 Event(s)

The table below defines the 'Event(s)' of the 'BP0842. Handle Goods discharge and License/CVED usage registration following amendment' process.

Element Name	Description	Special Type
BPE6051. Cancel previous Goods	The system sends to the goods discharge tracking system a cancellation request for an already registered goods discharge	Intermediate
BPE6052. Cancel previous license/CVED usage	The system sends to EXIM a cancellation request for an already registered licenses	Intermediate
BPE6054. Start Goods discharge and License/CVED usage amendment	The process starts when amendment of the goods discharge and license usage is required due to declaration amendment	Start
BPE6055. Request Goods Discharge (following amendment)	Request Goods Discharge (following amendment)	Intermediate
BPE6056. Register license/CVED usage (following amendment)	Register license/CVED usage (following amendment)	Intermediate
BPE6057. Handling of Goods Discharge and License/CVED usage amendment completed	Handling of Goods Discharge and License/CVED usage amendment completed	End

2.9.6.2 Gateway(s)

The table below defines the 'Gateway(s)' of the 'BP0842. Handle Goods discharge and License/CVED usage registration following amendment' process.

Element Name	Description	Special Type
BPE6041. Is Goods Discharge required?	A decision point in the process to navigate the flow based on whether a Goods Discharge Decision required?	
↳ Business Rule	425 <i>Goods Discharge required</i>	

↳ **Business Rule** 499 *Goods Discharge required (Export/Import Specific)*

BPE6043. Is License/CVED usage registration required? A decision point in the process to navigate the flow based on whether License/CVED usage registration required Decision

↳ **Business Rule** 424 *License/CVED usage registration required*

CARM Customs Declaration and Excise Documents Processing system (CDEPS)	REF: CDEPS_EXPORT_BPS
Business Process Specifications for EXPORT System	VER:410

2.10. Process Group: Export operation Cancellation at Export

2.10.1.BP0148. Process Cancellation @ Office of Export

Business Process Description

The following table provides general information about the 'BP0148. Process Cancellation @ Office of Export' process. The Business Process Diagram and the description of various business process elements are specified in the following paragraphs.

Description	A high level process describing the actions performed by the system in order to handle the cancellation request received electronically from the Trader or on paper at the Office of Export.
Precondition(s)	<ul style="list-style-type: none"> - Accepted - Waiting for Control Decision - Under Release Request - Under Release - Declaration Under Amendment - Idle - Guarantee Under Amendment - Follow – Up Recommended - Under Exit Confirmation request - Under Cancellation Decision - Goods released for Export - Goods released for Export with Transit
Trigger	The process is triggered either by the cancellation request received from Trader or by the manual action of Customs Officer
Postcondition(s)	<ul style="list-style-type: none"> - None - Cancelled

Business Process Diagram

The Business Process Diagram of 'BP0148. Process Cancellation @ Office of Export' is shown below in BPMN notation. The definition of a process that might be used as sub-process by the 'BP0148. Process Cancellation @ Office of Export' can be found in this document. Finally, Annex A of CDEPS-BPS-EXPORT provides some explanatory information about the used notation.

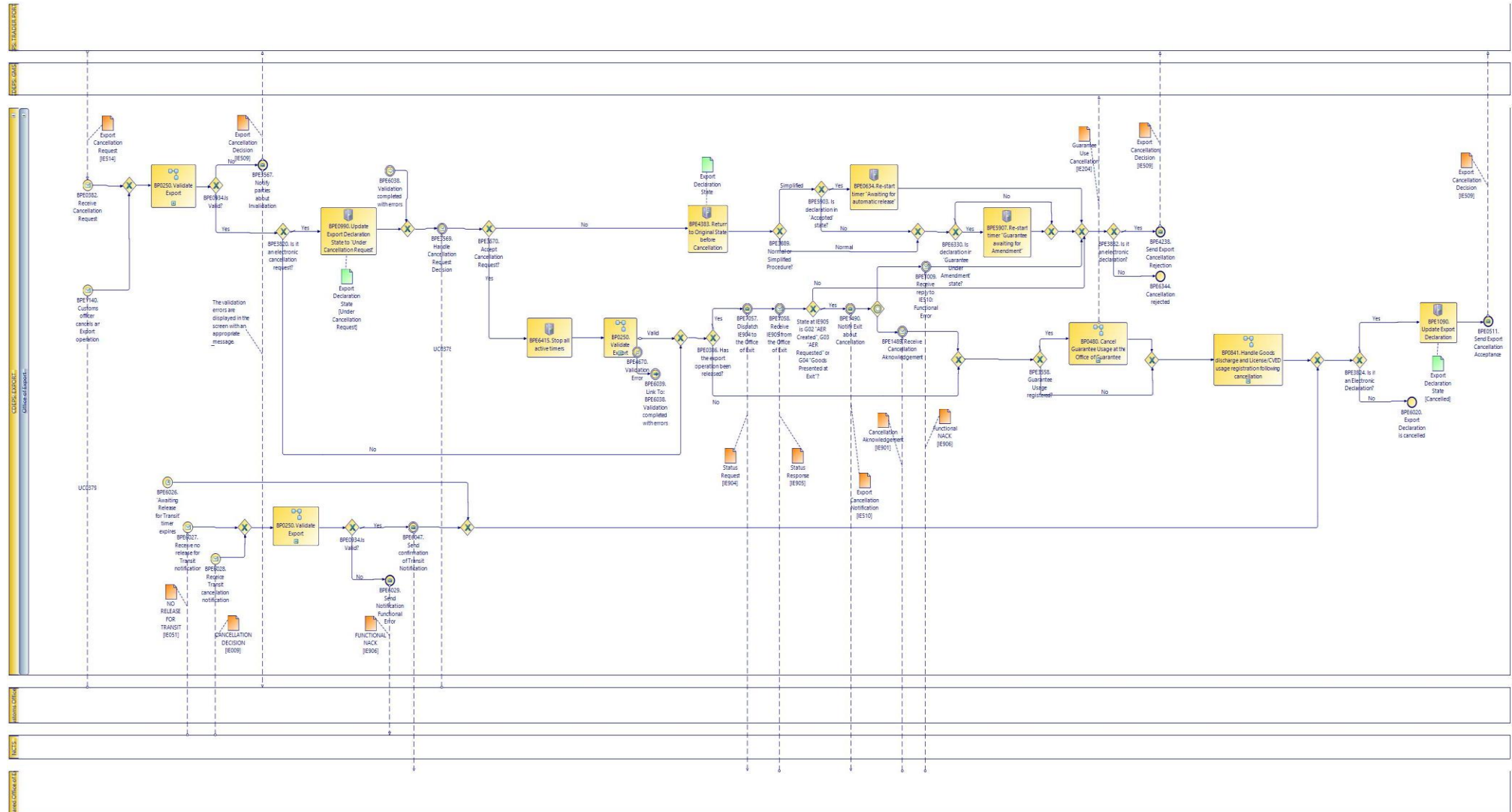

CARM Customs Declaration and Excise Documents Processing system (CDEPS)	REF: CDEPS_EXPORT_BPS
Business Process Specifications for EXPORT System	VER:410

2.10.1.1 Activities

The table below defines the 'Activities' of the 'BP0148. Process Cancellation @ Office of Export' process.

Element Name	Description	Special Type
BPE0634. Re-start timer "Awaiting for automatic release"	System resets the "Awaiting for automatic release" timer	Service Task
BPE0990. Update Export Declaration State to 'Under Cancellation Request'	The system updates the Export declaration state to 'Under Cancellation Request'	Service Task
BPE1090. Update Export Declaration State to 'Cancelled'	The system updated the Export Declaration State to 'Cancelled'	Service Task
BPE3848. Cancel license(s)/CVED usage	Cancel license(s)/CVED usage	Service Task
BPE4383. Return to Original State before Cancellation Request	Return to Original State before Cancellation Request	Service Task
BPE5907. Re-start timer "Guarantee awaiting for Amendment"	System resets the "Guarantee Awaiting Amendment" timer	Service Task
BPE6415. Stop all active timers	Following the cancellation of the declaration the system stops all active timers.	Service Task

↳ **Business Rule** 287 *Stop timers due to declaration cancellation (Export)*

CARM Customs Declaration and Excise Documents Processing system (CDEPS)	REF: CDEPS_EXPORT_BPS
Business Process Specifications for EXPORT System	VER:410

2.10.1.2 Event(s)

The table below defines the 'Event(s)' of the 'BP0148. Process Cancellation @ Office of Export' process.

Element Name	Description	Special Type
BPE0382. Receive Cancellation Request	The Exporter/Declarant submits a cancellation request for his declaration which has previously been accepted or released.	Start
BPE0511. Send Export Cancellation Acceptance	Send Export Cancellation Acceptance	End
BPE1009. Receive reply to IE510: Functional Error	Receive reply to IE510: Functional Error	Intermediate
BPE1140. Customs officer cancels an Export operation		Start
BPE1489. Receive Cancellation Acknowledgement	Receive Cancellation Acknowledgement	Intermediate
BPE1490. Notify Exit about Cancellation	Notify Exit about Cancellation	Intermediate
BPE3567. Notify parties about Invalidation	The parties are notified about the Invalidation of the cancellation request	End
BPE3569. Handle Cancellation Request Decision	The system handles the Cancellation Request Decision.	Intermediate
BPE3849. Notify EXIM of license(s) usage cancellation	Notify EXIM of license(s) usage cancellation	Intermediate
BPE4238. Send Export Cancellation Rejection	Send Export Cancellation Rejection to the Trader	End

CARM Customs Declaration and Excise Documents Processing system (CDEPS)	REF: CDEPS_EXPORT_BPS
Business Process Specifications for EXPORT System	VER:410
BPE6020. Export Declaration is cancelled	The Export Declaration is cancelled. End
BPE6026. 'Awaiting Release for Transit' timer expires	The 'Awaiting Release for Transit' timer expires Start
BPE6027. Receive no release for Transit notification	The systems received no release for Transit notification Start
BPE6028. Receive Transit cancellation notification	The system received the Transit cancellation notification Start
BPE6029. Send Notification Functional Error	Send Notification Functional Error End
BPE6038. Validation completed with errors	A throw link in the process navigating the flow when the validation errors are reported Intermediate
BPE6039. Link To: BPE6038. Validation completed with errors	An intermediate event in the process linked to: BPE6038. Validation completed with errors Intermediate
BPE6047. Send confirmation of Transit Notification	Send confirmation of Transit Notification End
BPE6344. Cancellation rejected	Cancellation rejected End
BPE7057. Dispatch IE904 to the Office of Exit	Dispatch IE904 message to the Office of Exit. Intermediate
BPE7058. Receive IE905 from the Office of Exit	Receive IE905 message from the Office of Exit. Intermediate

CARM Customs Declaration and Excise Documents Processing system (CDEPS)	REF: CDEPS_EXPORT_BPS
Business Process Specifications for EXPORT System	VER:410

2.10.1.3 Gateway(s)

The table below defines the 'Gateway(s)' of the 'BP0148. Process Cancellation @ Office of Export' process.

Element Name	Description	Special Type
BPE0386. Has the export operation been released?	The system checks whether the movement has been released from the Office of Export before proceeding with the cancellation.	Decision
↳ Business Rule 56	<i>Release of movement from OoExp</i>	
BPE0934. Is Valid?	A decision point in the process to navigate the flow based on the message validation result.	Decision
↳ Business Rule 638	<i>Import declaration type 'X' cannot be cancelled</i>	
↳ Business Rule 646	<i>Guarantees during the registration of Import declaration type 'X'</i>	
↳ Business Rule 80	<i>Valid Message</i>	
BPE3558. Guarantee Usage registered?	A decision point in the process to navigate the flow based on whether the guarantee usage has been registered	Decision
BPE3570. Accept Cancellation Request?	A decision point in the process to navigate the flow based on whether the cancellation request is accepted	Decision
↳ Business Rule 313	<i>Cancellation after movement exportation</i>	
BPE3820. Is it an electronic cancellation request?	A decision point in the process to navigate the flow based on whether the cancellation request was received electronically by the Trader or submitted manually by the Customs Officer	Decision
BPE3824. Is it an Electronic Declaration?	A decision point in the process to navigate the flow based on whether the declaration is electronic or not	Decision
BPE3845. License(s) Usage already registered?	A decision point in the process to navigate the flow based on whether the usage of the licenses has been already registered or not	Decision
BPE3882. Is it an electronic declaration?	A decision point in the process to navigate the flow based on whether the declaration is electronic or not	Decision

CARM Customs Declaration and Excise Documents Processing system (CDEPS)	REF: CDEPS_EXPORT_BPS
Business Process Specifications for EXPORT System	VER:410
BPE3889. Normal or Simplified Procedure?	A decision point in the process to split the flow based on whether it is a normal or simplified procedure. Decision
BPE5903. Is declaration in 'Accepted' state?	A decision point in the flow to navigate the process based on the declaration state Decision
BPE6330. Is declaration in 'Guarantee Under Amendment' state?	Is declaration in 'Guarantee Under Amendment' state? Decision

CARM Customs Declaration and Excise Documents Processing system (CDEPS)	REF: CDEPS_EXPORT_BPS
Business Process Specifications for EXPORT System	VER:410

2.10.2.BP0250. Validate Export

Business Process Description

The following table provides general information about the 'BP0250. Validate Export' process. The Business Process Diagram and the description of various business process elements are specified in the following paragraphs.

Description	Reusable subprocess that performs the message validation tasks for Export Regime.
Precondition(s)	None
Trigger	The process is triggered when an electronic message is received for validation.
Postcondition(s)	The validation is either completed successfully or with errors reported

Business Process Diagram

The Business Process Diagram of 'BP0250. Validate Export' is shown below in BPMN notation. The definition of a process that might be used as sub-process by the 'BP0250. Validate Export' can be found in this document. Finally, Annex A of CDEPS-BPS-EXPORT provides some explanatory information about the used notation.

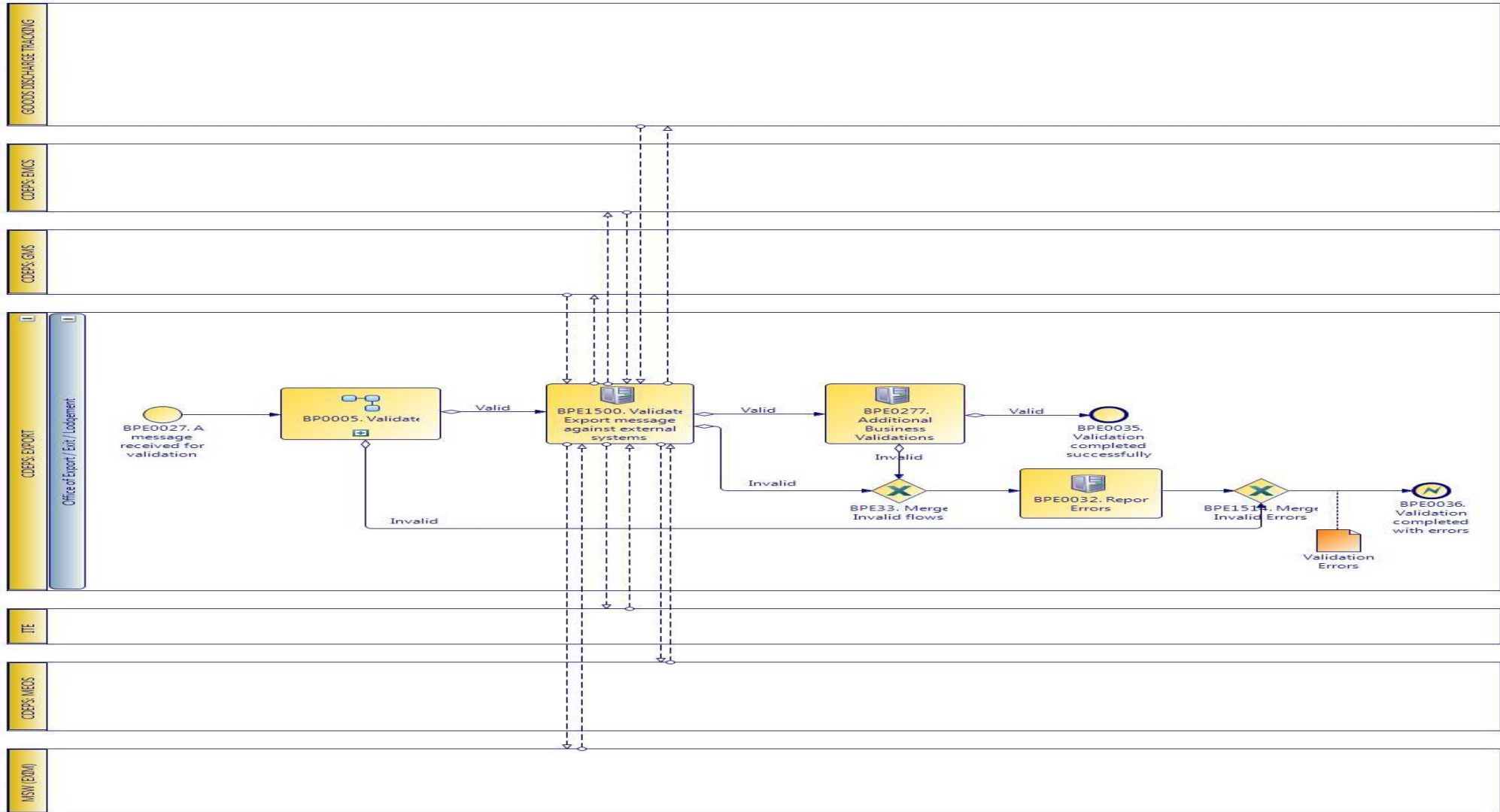

CARM Customs Declaration and Excise Documents Processing system (CDEPS)	REF: CDEPS_EXPORT_BPS
Business Process Specifications for EXPORT System	VER:410

2.10.2.1 Activities

The table below defines the 'Activities' of the 'BP0250. Validate Export' process.

Element Name	Description	Special Type
BPE0032. Report Errors	Report the identified errors from the validation process. The process terminates.	Service Task
BPE0277. Additional Business Validations for Export	The system performs any additional business validations specific to Export System.	Service Task
↳ Business Rule 19	Trader amending data same as Person lodging the declaration	
↳ Business Rule 21	Reject ENS/EXS amendment if ENS/EXS is not in appropriate state	
↳ Business Rule 245	Validate Personal ID	
↳ Business Rule 39	Cancellation Constraint	
↳ Business Rule 520	Import/ Export allowed guarantee types	
↳ Business Rule 70	EXS exists at the Office of Exit	
↳ Business Rule 71	Manifest number in IE547 and IE590	
BPE1500. Validate Export message against external systems	The system performs message validations against external systems.	Service Task
↳ Business Rule 101	Validate Economic Operator against MEOS	
↳ Business Rule 422	Validation of NCTS notifications	
↳ Business Rule 425	Goods Discharge required	
↳ Business Rule 439	Validate against GMS for integrity check	
↳ Business Rule 440	Validate Economic Operator's TIN against MEOS	
↳ Business Rule 494	Orchestrate validation of Export message against external systems	
↳ Business Rule 508	Validation of Export licenses with EXIM	

CARM Customs Declaration and Excise Documents Processing system (CDEPS)	REF: CDEPS_EXPORT_BPS
Business Process Specifications for EXPORT System	VER:410
↳ Business Rule 509	Check Export authorizations with MEOS
↳ Business Rule 51	Validate declared Combined Nomenclature in Declaration against ITE.
↳ Business Rule 510	Check Export authorizations for representation with MEOS
↳ Business Rule 511	Check Evidence of Power of Attorney with MEOS
↳ Business Rule 521	Validate Export declaration against ITE (duty calculation).
↳ Business Rule 522	Validate Export declaration data against Goods Discharge Tracking system
↳ Business Rule 527	Validate Export Declaration data against Excise system

2.10.2.2 Event(s)

The table below defines the 'Event(s)' of the 'BP0250. Validate Export' process.

Element Name	Description	Special Type
BPE0027. A message or event notification from GUI is received for validation	Message input in the validation process.	Start
BPE0035. Validation completed successfully	The validation is completed successfully with no errors reported. The process terminates.	End
BPE0036. Validation completed with errors	The validation completed with errors. The process terminates.	End

2.10.2.3 Gateway(s)

The table below defines the 'Gateway(s)' of the 'BP0250. Validate Export' process.

Element Name	Description	Special Type
BPE1514. Merge Invalid Errors	Combines exclusively either the negative outcome of generic validate process (BP0005. Validate) which reports errors or the errors from the extra checks for the specific system.	Merge

CARM Customs Declaration and Excise Documents Processing system (CDEPS)	REF: CDEPS_EXPORT_BPS
Business Process Specifications for EXPORT System	VER:410

2.10.3.BP0480. Cancel Guarantee Usage at the Office of Guarantee

Business Process Description

The following table provides general information about the 'BP0480. Cancel Guarantee Usage at the Office of Guarantee' process. The Business Process Diagram and the description of various business process elements are specified in the following paragraphs.

Description	Reusable subprocess that describes the tasks performed by the system in order to cancel the usage of the selected guarantee due to movement's cancellation/amendment
Precondition(s)	The Guarantee usage to be cancelled due to movement's cancellation/amendment are selected
Trigger	The process starts when the Guarantee usage to be cancelled due to movement's cancellation/amendment are selected
Postcondition(s)	The guarantee usage is cancelled

Business Process Diagram

The Business Process Diagram of 'BP0480. Cancel Guarantee Usage at the Office of Guarantee' is shown below in BPMN notation. The definition of a process that might be used as sub-process by the 'BP0480. Cancel Guarantee Usage at the Office of Guarantee' can be found in this document. Finally, Annex A of CDEPS-BPS-EXPORT provides some explanatory information about the used notation.

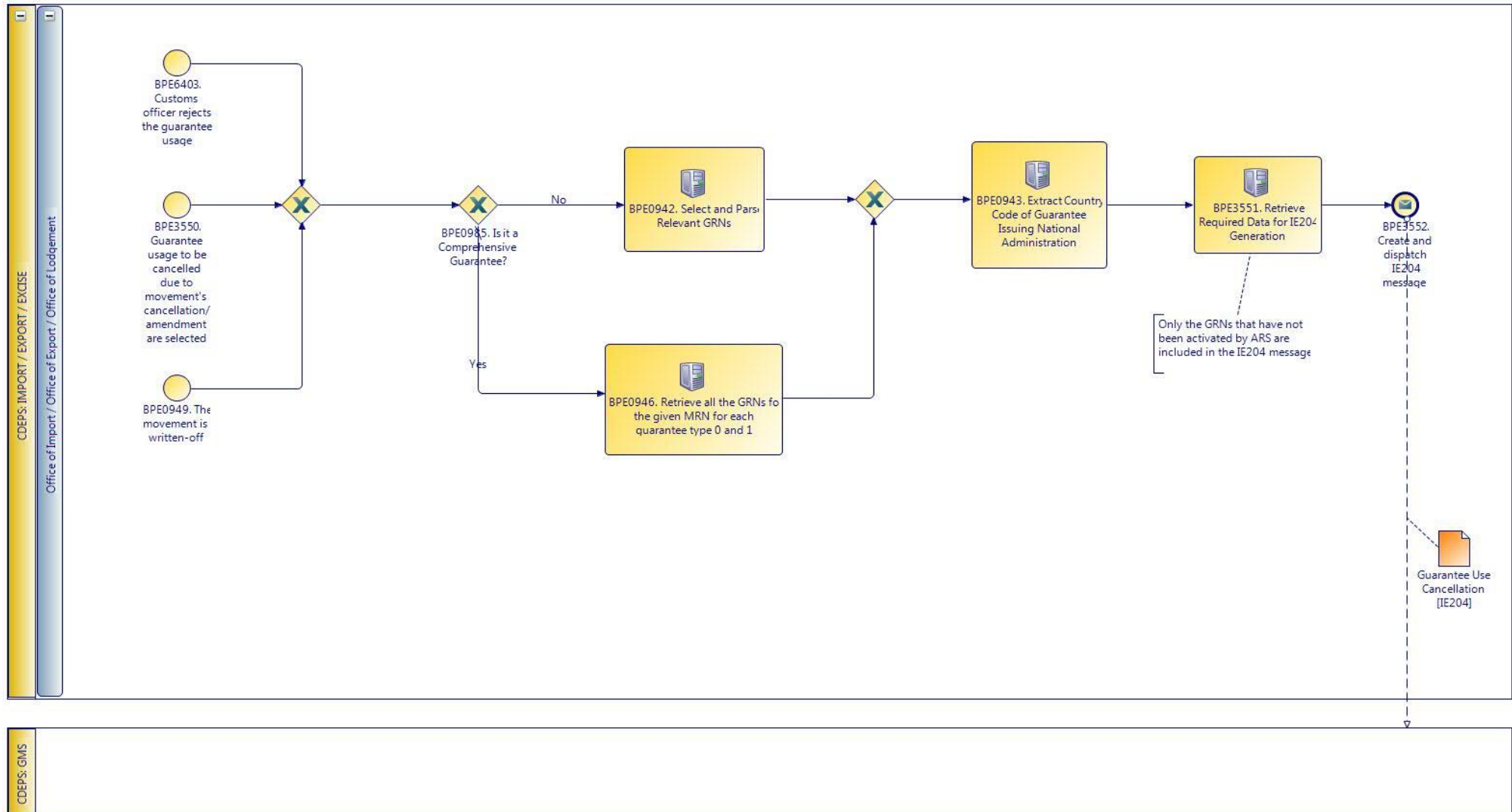

CARM Customs Declaration and Excise Documents Processing system (CDEPS)	REF: CDEPS_EXPORT_BPS
Business Process Specifications for EXPORT System	VER:410

2.10.3.1 Activities

The table below defines the 'Activities' of the 'BP0480. Cancel Guarantee Usage at the Office of Guarantee' process.

Element Name	Description	Special Type
BPE0942. Select and Parse Relevant GRNs	Select and Parse Relevant GRNs	Service Task
BPE0943. Extract Country Code of Guarantee Issuing National Administration	Extract Country Code of Guarantee Issuing National Administration	Service Task
BPE0946. Retrieve all the GRNs for the given MRN for each guarantee type 0 and 1	Retrieve all the GRNs for the given MRN for each guarantee type 0 and 1	Service Task
BPE3551. Retrieve Required Data for IE204 Generation	Retrieve Required Data for IE204 Generation	Service Task
↳ Business Rule 555	<i>Required data for IE204 generation</i>	

2.10.3.2 Event(s)

The table below defines the 'Event(s)' of the 'BP0480. Cancel Guarantee Usage at the Office of Guarantee' process.

Element Name	Description	Special Type
BPE0949. The movement is written-off	The movement is written-off	Start
BPE3550. Guarantee usage to be cancelled due to movement's cancellation/amendment are selected	Guarantee usage to be cancelled due to movement's cancellation/amendment are selected	Start

CARM Customs Declaration and Excise Documents Processing system (CDEPS)	REF: CDEPS_EXPORT_BPS
Business Process Specifications for EXPORT System	VER:410

BPE3552. Create and dispatch IE204 message	Create and dispatch IE204 message	End
BPE6403. Customs officer rejects the guarantee usage	Customs officer rejects the guarantee usage	Start

2.10.3.3 Gateway(s)

The table below defines the 'Gateway(s)' of the 'BP0480. Cancel Guarantee Usage at the Office of Guarantee' process.

Element Name	Description	Special Type
BPE0985. Is it a Comprehensive Guarantee?	A decision point in the process to navigate the flow based on the Guarantee type	Decision

CARM Customs Declaration and Excise Documents Processing system (CDEPS)	REF: CDEPS_EXPORT_BPS
Business Process Specifications for EXPORT System	VER:410

2.10.4.BP0005. Validate

Business Process Description

The following table provides general information about the 'BP0005. Validate' process. The Business Process Diagram and the description of various business process elements are specified in the following paragraphs.

Description	Reusable subprocess that performs the message validation tasks
Precondition(s)	None
Trigger	The process is triggered when an electronic message is received for validation.
Postcondition(s)	

Business Process Diagram

The Business Process Diagram of 'BP0005. Validate' is shown below in BPMN notation. The definition of a process that might be used as sub-process by the 'BP0005. Validate' can be found in this document. Finally, Annex A of CDEPS-BPS-EXPORT provides some explanatory information about the used notation.

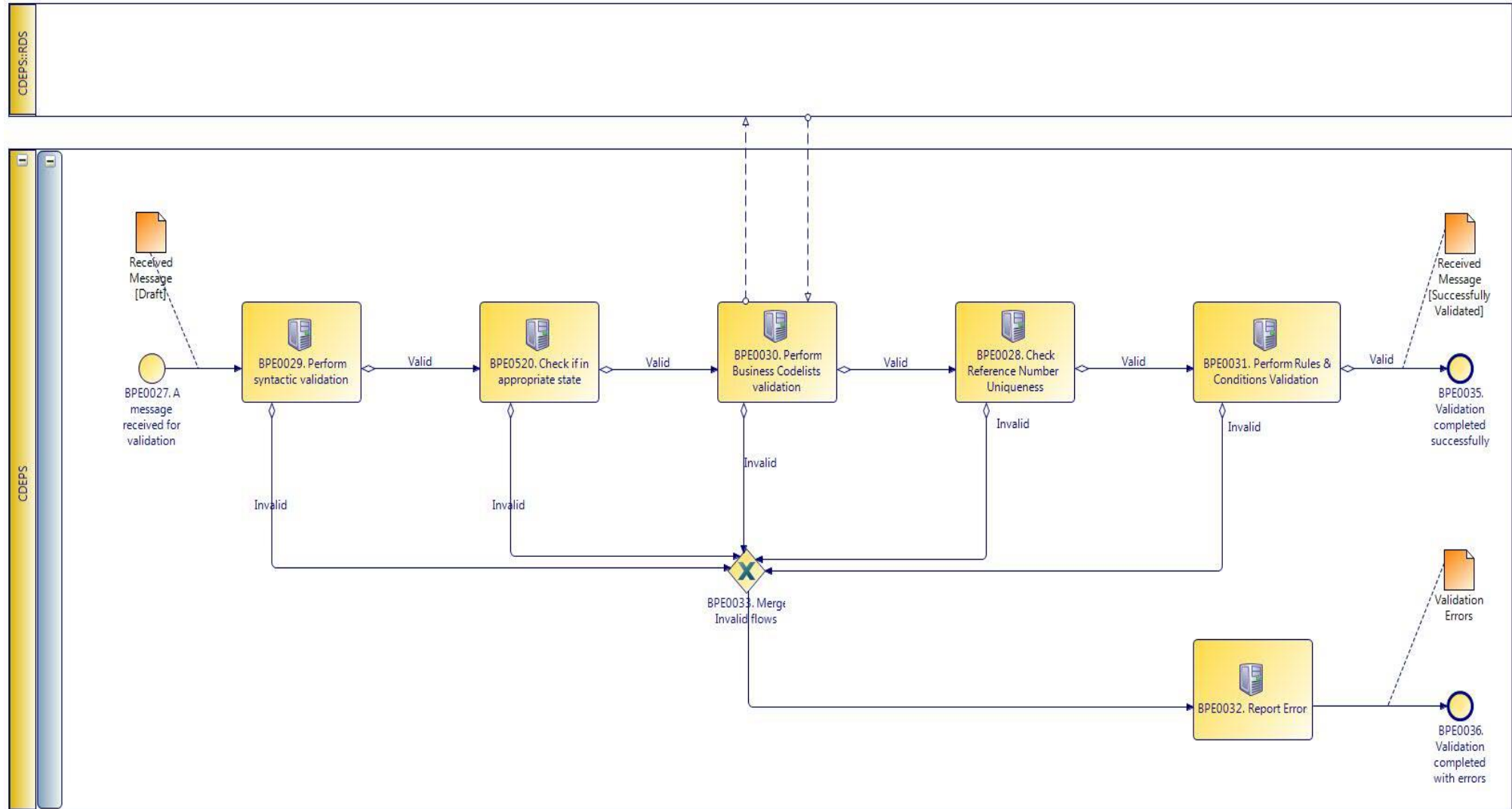

CARM Customs Declaration and Excise Documents Processing system (CDEPS)	REF: CDEPS_EXPORT_BPS
Business Process Specifications for EXPORT System	VER:410

2.10.4.1 Activities

The table below defines the 'Activities' of the 'BP0005. Validate' process.

Element Name	Description	Special Type
BPE0028. Check Reference Number Uniqueness	Check whether message reference numbers are unique in the system.	Service Task
↳ Business Rule 1	<i>Check Message Identification uniqueness</i>	
↳ Business Rule 74	<i>Check Local Reference Number (LRN) uniqueness</i>	
↳ Business Rule 75	<i>Check Movement Reference Number (MRN)uniqueness</i>	
↳ Business Rule 79	<i>Check Manifest reference number uniqueness</i>	
BPE0029. Perform syntactic validation	Check messages against the XSDs.	Service Task
↳ Business Rule 47	<i>Syntactic validation</i>	
BPE0030. Perform Business Codelists validation	Check the message business codelists.	Service Task
↳ Business Rule 50	<i>Business codelist validation against CDEPS:RDS</i>	
BPE0031. Perform Rules & Conditions Validation	Check the rules and conditions of the respective message.	Service Task
BPE0032. Report Errors	Report the identified errors from the validation process. The process terminates.	Service Task
BPE0520. Check if in appropriate state	Check whether the process for the particular entity (e.g. declaration/ application/ document) is on the appropriate state to process the received message. This check shall be performed based on the pertinent State Model of the system.	Service Task
↳ Business Rule 421	<i>Supplementary Declaration validation at Export</i>	
↳ Business Rule 448	<i>Check appropriate state for Export Declaration Amendment</i>	

CARM Customs Declaration and Excise Documents Processing system (CDEPS)	REF: CDEPS_EXPORT_BPS
Business Process Specifications for EXPORT System	VER:410

- ↳ **Business Rule** 449 *Check appropriate state Declaration Goods Presentation*
- ↳ **Business Rule** 468 *Guarantee Amendment*
- ↳ **Business Rule** 492 *Exit control results received at Export*
- ↳ **Business Rule** 493 *Export Declaration request at Export*

2.10.4.2 Event(s)

The table below defines the 'Event(s)' of the 'BP0005. Validate' process.

Element Name	Description	Special Type
BPE0027. A message or event notification from GUI is received for validation	Message input in the validation process.	Start
BPE0035. Validation completed successfully	The validation is completed successfully with no errors reported. The process terminates.	End
BPE0036. Validation completed with errors	The validation completed with errors. The process terminates.	End

2.10.4.3 Gateway(s)

The table below defines the 'Gateway(s)' of the 'BP0005. Validate' process.

Element Name	Description	Special Type
BPE0033. Merge Invalid Flows	Merge into exclusive event based gateway the invalid flows from all validation tasks.	Merge

CARM Customs Declaration and Excise Documents Processing system (CDEPS)	REF: CDEPS_EXPORT_BPS
Business Process Specifications for EXPORT System	VER:410

2.10.5.BP0246. Handle Pre-validation request

Business Process Description

The following table provides general information about the 'BP0246. Handle Pre-validation request' process. The Business Process Diagram and the description of various business process elements are specified in the following paragraphs.

Description	The process handles a request received from the Trader Portal for the pre-validation of any message. The process terminates with either a positive or negative reply back to the Trader Portal.
Precondition(s)	
Trigger	
Postcondition(s)	

Business Process Diagram

The Business Process Diagram of 'BP0246. Handle Pre-validation request' is shown below in BPMN notation. The definition of a process that might be used as sub-process by the 'BP0246. Handle Pre-validation request' can be found in this document. Finally, Annex A of CDEPS-BPS-EXPORT provides some explanatory information about the used notation.

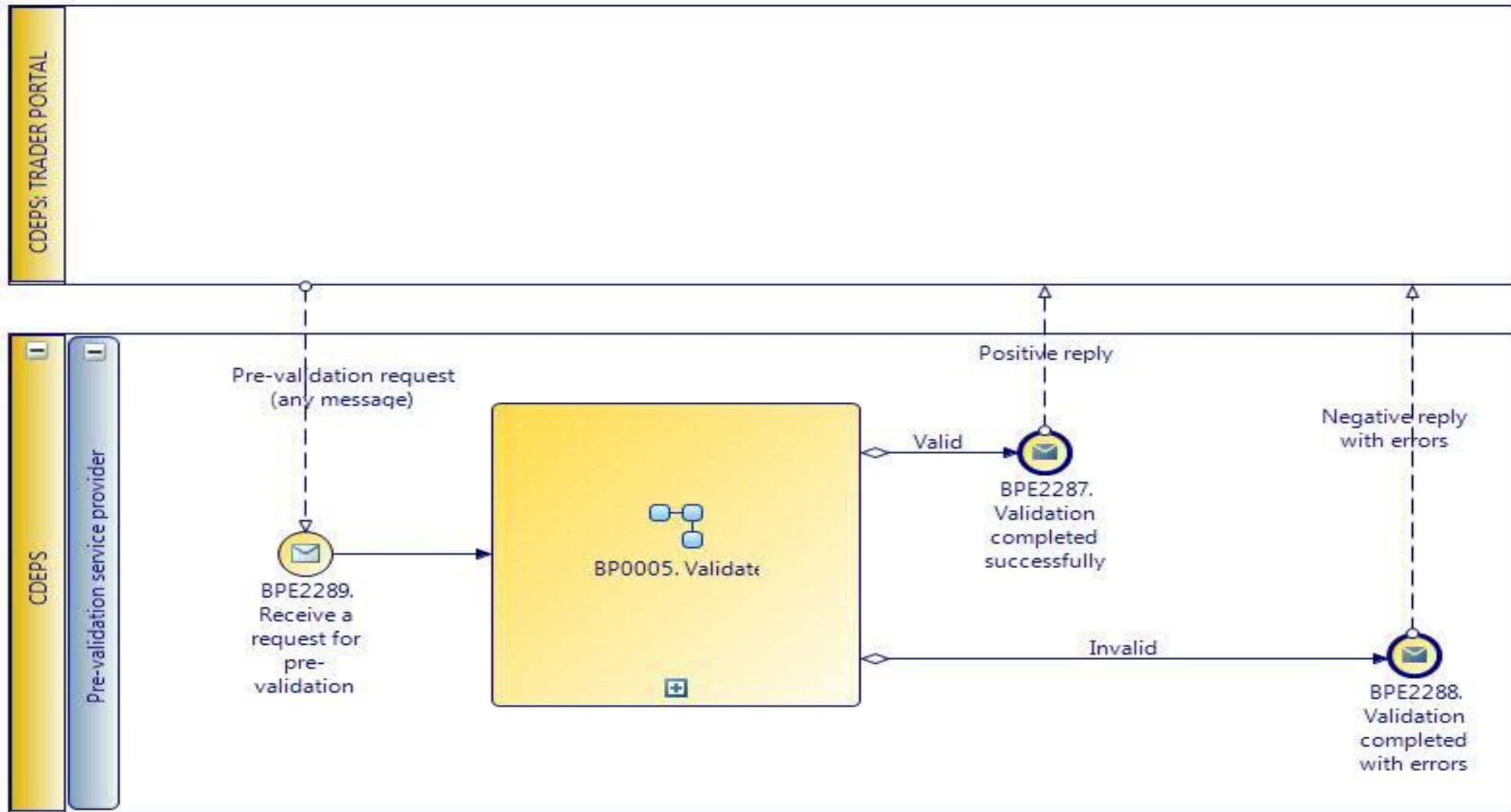

CARM Customs Declaration and Excise Documents Processing system (CDEPS)	REF: CDEPS_EXPORT_BPS
Business Process Specifications for EXPORT System	VER:410

2.10.5.1 Event(s)

The table below defines the 'Event(s)' of the 'BP0246. Handle Pre-validation request' process.

Element Name	Description	Special Type
BPE2287. Validation completed successfully	The validation is completed successfully with no errors reported. The process terminates and informs requesting system accordingly.	End
BPE2288. Validation completed with errors	The validation completed with errors. The process terminates and informs requesting system accordingly.	End
BPE2289. Receive a request for pre-validation	A pre-validation request is received from Trader Portal for a specific message.	Start

CARM Customs Declaration and Excise Documents Processing system (CDEPS)	REF: CDEPS_EXPORT_BPS
Business Process Specifications for EXPORT System	VER:410

2.10.6.BP0841. Handle Goods discharge and License/CVED usage registration following cancellation

Business Process Description

The following table provides general information about the 'BP0841. Handle Goods discharge and License/CVED usage registration following cancellation' process. The Business Process Diagram and the description of various business process elements are specified in the following paragraphs.

Description	The process handles the cancellation of an already registered goods discharge and the cancellation of an already registered License/CVED usage.
Precondition(s)	The declaration is already accepted and the Goods discharge and/or license usage has been registered
Trigger	Manual cancellation from the Customs Officer or electronically by the Trader
Postcondition(s)	The Goods discharge and/or license usage is cancelled

Business Process Diagram

The Business Process Diagram of 'BP0841. Handle Goods discharge and License/CVED usage registration following cancellation' is shown below in BPMN notation. The definition of a process that might be used as sub-process by the 'BP0841. Handle Goods discharge and License/CVED usage registration following cancellation' can be found in this document. Finally, Annex A of CDEPS-BPS-EXPORT provides some explanatory information about the used notation.

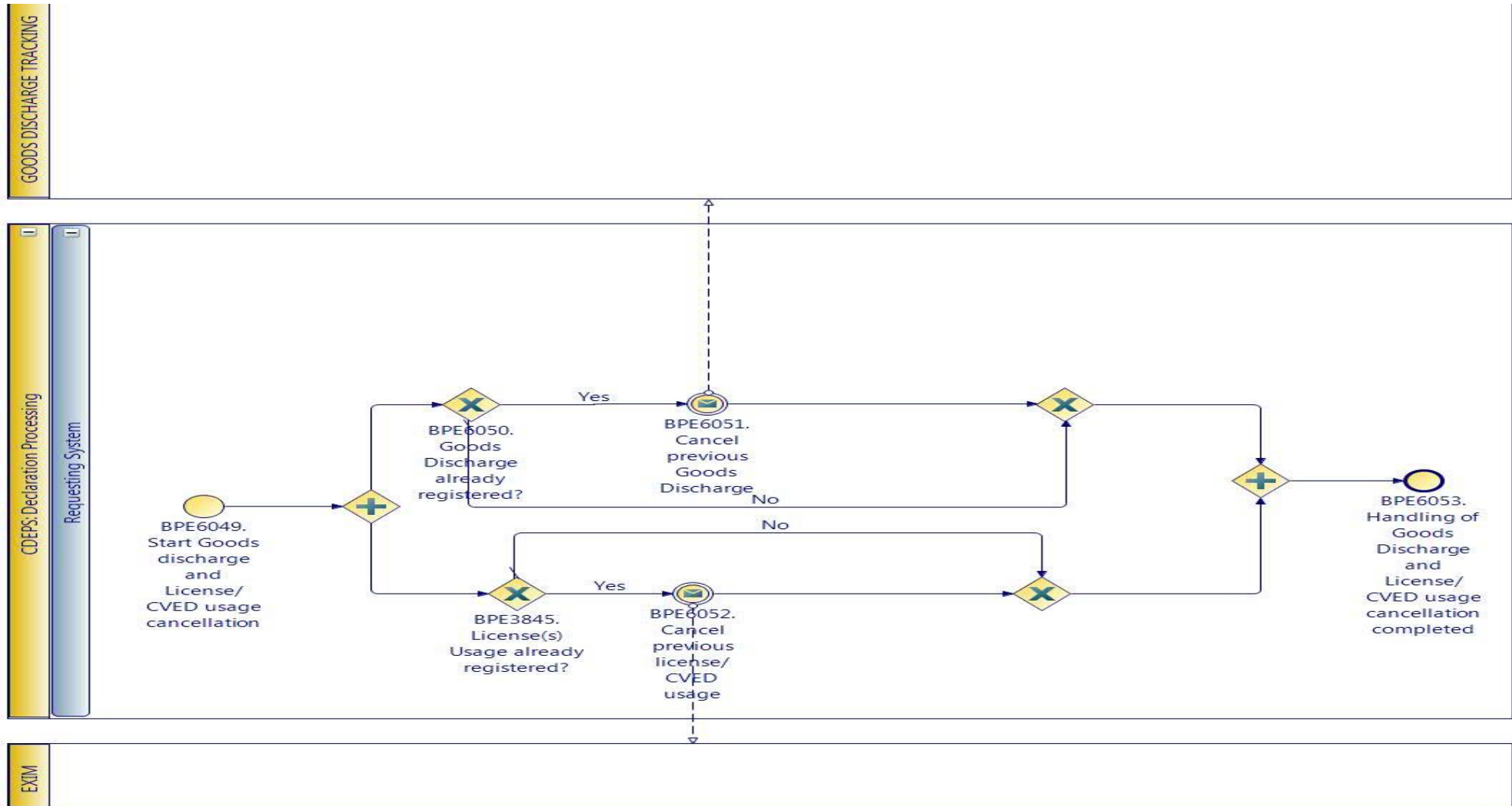

CARM Customs Declaration and Excise Documents Processing system (CDEPS)	REF: CDEPS_EXPORT_BPS
Business Process Specifications for EXPORT System	VER:410

2.10.6.1 Event(s)

The table below defines the 'Event(s)' of the 'BP0841. Handle Goods discharge and License/CVED usage registration following cancellation' process.

Element Name	Description	Special Type
BPE6049. Start Goods discharge and License/CVED usage cancellation	The process starts when the cancellation of the Goods discharge and License/CVED usage is required	Start
BPE6051. Cancel previous Goods	The system sends to the goods discharge tracking system a cancellation request for an already registered goods discharge	Intermediate
BPE6052. Cancel previous license/CVED usage	The system sends to EXIM a cancellation request for an already registered licenses	Intermediate
BPE6053. Handling of Goods Discharge and License/CVED usage cancellation completed	Handling of Goods Discharge and License/CVED usage cancellation completed	End

2.10.6.2 Gateway(s)

The table below defines the 'Gateway(s)' of the 'BP0841. Handle Goods discharge and License/CVED usage registration following cancellation' process.

Element Name	Description	Special Type
BPE3845. License(s) Usage already registered?	A decision point in the process to navigate the flow based on whether the usage of the licenses has been already registered or not	Decision
BPE6050. Goods Discharge already registered?	A decision point in the process to navigate the flow based on whether a Goods Discharge has been already registered	Decision

CARM Customs Declaration and Excise Documents Processing system (CDEPS)	REF: CDEPS_EXPORT_BPS
Business Process Specifications for EXPORT System	VER:410

2.11. Process Group: Export operation Cancellation at Exit

2.11.1.BP0149. Process Cancellation @ Declared Office of Exit

Business Process Description

The following table provides general information about the 'BP0149. Process Cancellation @ Declared Office of Exit' process. The Business Process Diagram and the description of various business process elements are specified in the following paragraphs.

Description	A high level process describing the actions performed by the system in order to handle the export cancellation at the Office of Exi.
Precondition(s)	None
Trigger	The process is triggered by the Export Cancellation Notification received from Office of Export
Postcondition(s)	- None - Cancelled

Business Process Diagram

The Business Process Diagram of 'BP0149. Process Cancellation @ Declared Office of Exit' is shown below in BPMN notation. The definition of a process that might be used as sub-process by the 'BP0149. Process Cancellation @ Declared Office of Exit' can be found in this document. Finally, Annex A of CDEPS-BPS-EXPORT provides some explanatory information about the used notation.

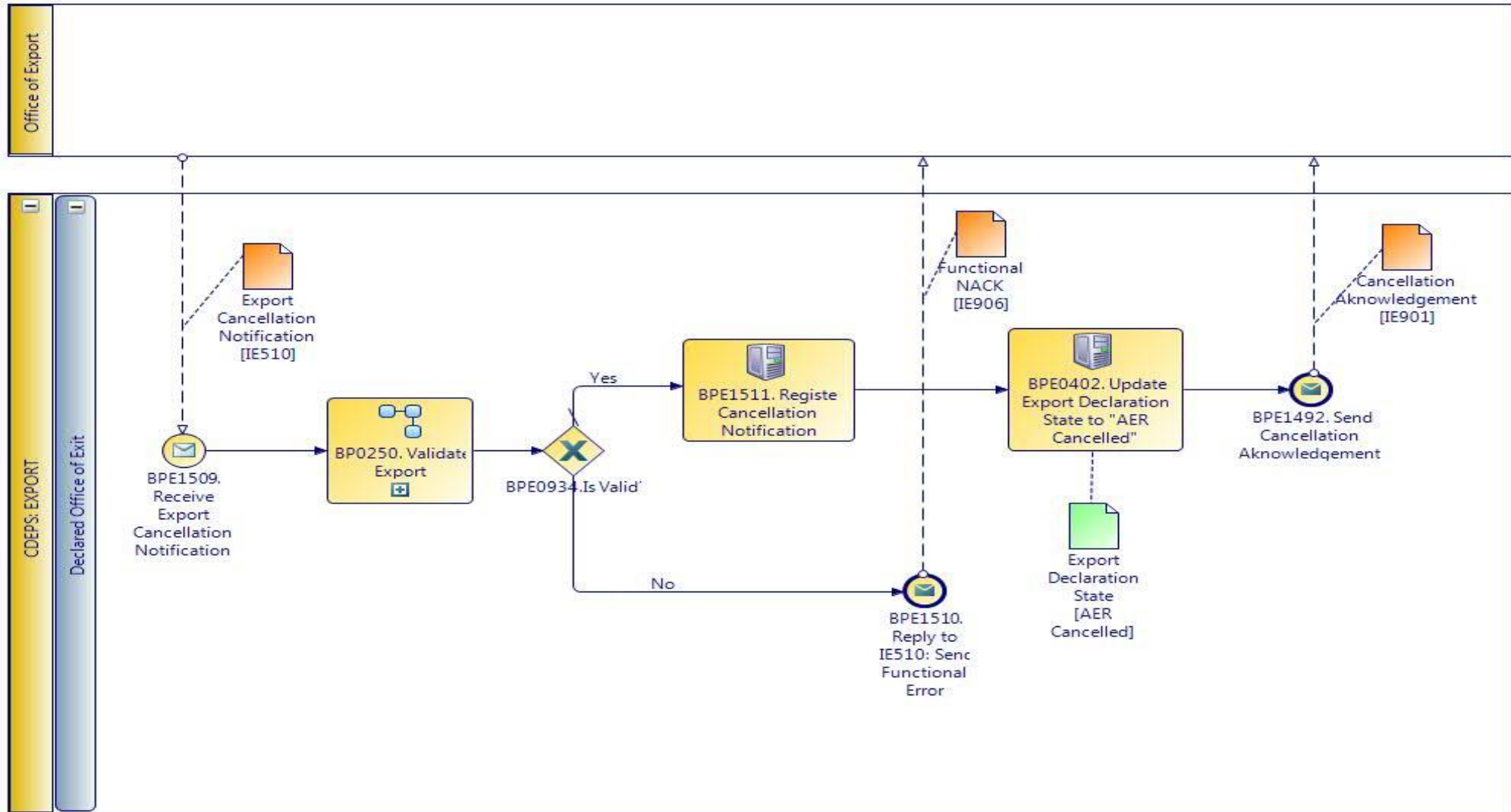

CARM Customs Declaration and Excise Documents Processing system (CDEPS)	REF: CDEPS_EXPORT_BPS
Business Process Specifications for EXPORT System	VER:410

2.11.1.1 Activities

The table below defines the 'Activities' of the 'BP0149. Process Cancellation @ Declared Office of Exit' process.

Element Name	Description	Special Type
BPE0402. Update Export Declaration State to "AER Cancelled"	The system updates the Exit movement state to "AER Cancelled".	User Task
BPE1511. Register Cancellation Notification	The system registers the Cancellation Notification upon its successful validation.	Service Task

2.11.1.2 Event(s)

The table below defines the 'Event(s)' of the 'BP0149. Process Cancellation @ Declared Office of Exit' process.

Element Name	Description	Special Type
BPE1492. Send Cancellation Acknowledgement	Send Cancellation Acknowledgement	End
BPE1509. Receive Export Cancellation Notification	The Office of Export receives an electronic cancellation request by the Trader	Start
BPE1510. Reply to IE510: Send Functional Error	The Office of Export is notified of the rejection of the export cancellation notification via an electronic functional error message.	End

2.11.1.3 Gateway(s)

The table below defines the 'Gateway(s)' of the 'BP0149. Process Cancellation @ Declared Office of Exit' process.

Element Name	Description	Special Type
BPE0934. Is Valid?	A decision point in the process to navigate the flow based on the message validation result.	Decision
↳ Business Rule 638	<i>Import declaration type 'X' cannot be cancelled</i>	
↳ Business Rule 646	<i>Guarantees during the registration of Import declaration type 'X'</i>	
↳ Business Rule 80	<i>Valid Message</i>	

CARM Customs Declaration and Excise Documents Processing system (CDEPS)	REF: CDEPS_EXPORT_BPS
Business Process Specifications for EXPORT System	VER:410

2.11.2.BP0250. Validate Export

Business Process Description

The following table provides general information about the 'BP0250. Validate Export' process. The Business Process Diagram and the description of various business process elements are specified in the following paragraphs.

Description	Reusable subprocess that performs the message validation tasks for Export Regime.
Precondition(s)	None
Trigger	The process is triggered when an electronic message is received for validation.
Postcondition(s)	The validation is either completed successfully or with errors reported

Business Process Diagram

The Business Process Diagram of 'BP0250. Validate Export' is shown below in BPMN notation. The definition of a process that might be used as sub-process by the 'BP0250. Validate Export' can be found in this document. Finally, Annex A of CDEPS-BPS-EXPORT provides some explanatory information about the used notation.

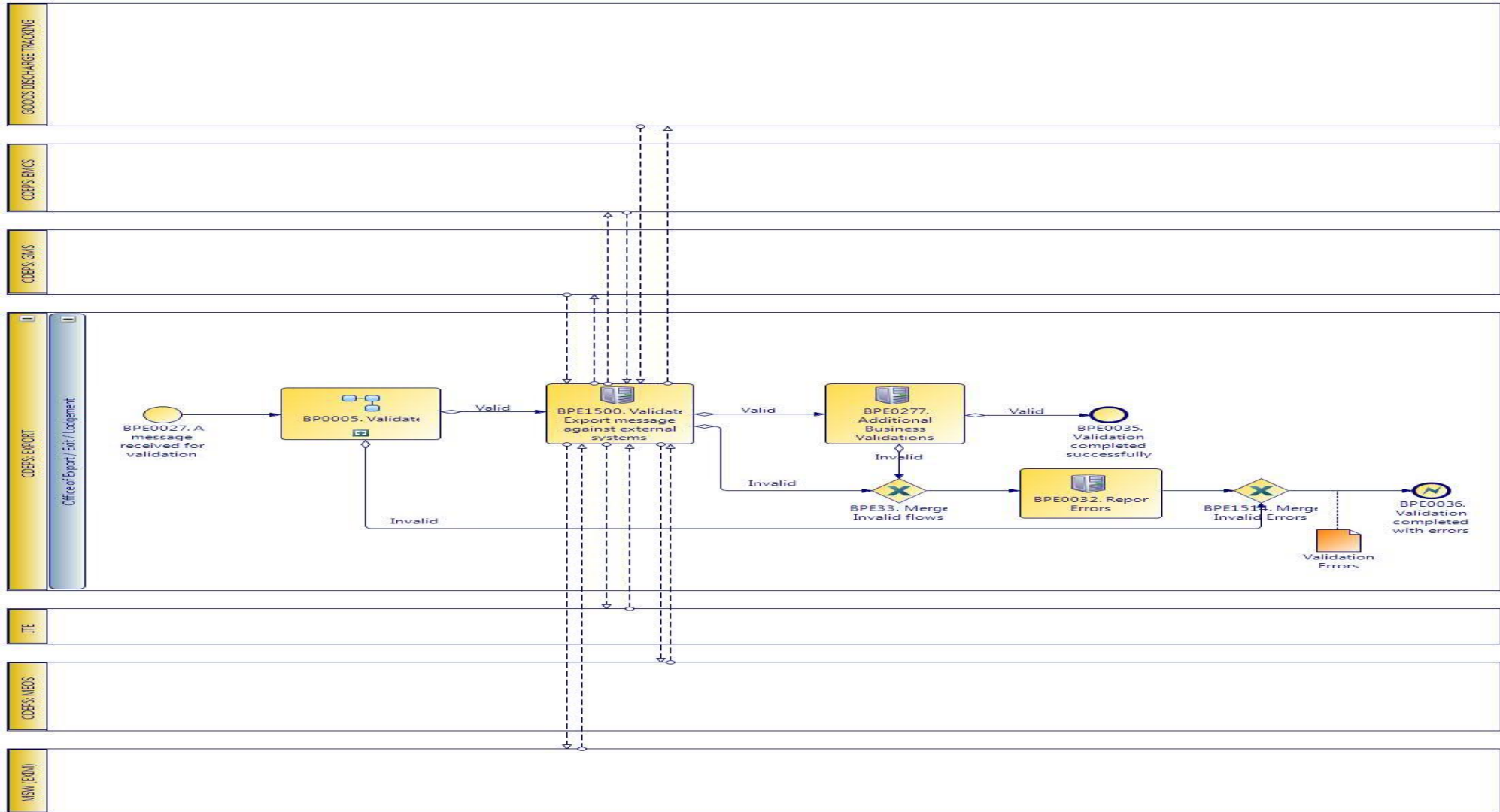

CARM Customs Declaration and Excise Documents Processing system (CDEPS)	REF: CDEPS_EXPORT_BPS
Business Process Specifications for EXPORT System	VER:410

2.11.2.1 Activities

The table below defines the 'Activities' of the 'BP0250. Validate Export' process.

Element Name	Description	Special Type
BPE0032. Report Errors	Report the identified errors from the validation process. The process terminates.	Service Task
BPE0277. Additional Business Validations for Export	The system performs any additional business validations specific to Export System.	Service Task
↳ Business Rule 19	Trader amending data same as Person lodging the declaration	
↳ Business Rule 21	Reject ENS/EXS amendment if ENS/EXS is not in appropriate state	
↳ Business Rule 245	Validate Personal ID	
↳ Business Rule 39	Cancellation Constraint	
↳ Business Rule 520	Import/ Export allowed guarantee types	
↳ Business Rule 70	EXS exists at the Office of Exit	
↳ Business Rule 71	Manifest number in IE547 and IE590	
BPE1500. Validate Export message against external systems	The system performs message validations against external systems.	Service Task
↳ Business Rule 101	Validate Economic Operator against MEOS	
↳ Business Rule 422	Validation of NCTS notifications	
↳ Business Rule 425	Goods Discharge required	
↳ Business Rule 439	Validate against GMS for integrity check	
↳ Business Rule 440	Validate Economic Operator's TIN against MEOS	
↳ Business Rule 494	Orchestrate validation of Export message against external systems	
↳ Business Rule 508	Validation of Export licenses with EXIM	

CARM Customs Declaration and Excise Documents Processing system (CDEPS)	REF: CDEPS_EXPORT_BPS
Business Process Specifications for EXPORT System	VER:410
↳ Business Rule 509	Check Export authorizations with MEOS
↳ Business Rule 51	Validate declared Combined Nomenclature in Declaration against ITE.
↳ Business Rule 510	Check Export authorizations for representation with MEOS
↳ Business Rule 511	Check Evidence of Power of Attorney with MEOS
↳ Business Rule 521	Validate Export declaration against ITE (duty calculation).
↳ Business Rule 522	Validate Export declaration data against Goods Discharge Tracking system
↳ Business Rule 527	Validate Export Declaration data against Excise system

2.11.2.2 Event(s)

The table below defines the 'Event(s)' of the 'BP0250. Validate Export' process.

Element Name	Description	Special Type
BPE0027. A message or event notification from GUI is received for validation	Message input in the validation process.	Start
BPE0035. Validation completed successfully	The validation is completed successfully with no errors reported. The process terminates.	End
BPE0036. Validation completed with errors	The validation completed with errors. The process terminates.	End

2.11.2.3 Gateway(s)

The table below defines the 'Gateway(s)' of the 'BP0250. Validate Export' process.

Element Name	Description	Special Type
BPE1514. Merge Invalid Errors	Combines exclusively either the negative outcome of generic validate process (BP0005. Validate) which reports errors or the errors from the extra checks for the specific system.	Merge

CARM Customs Declaration and Excise Documents Processing system (CDEPS)	REF: CDEPS_EXPORT_BPS
Business Process Specifications for EXPORT System	VER:410

2.11.3.BP0005. Validate

Business Process Description

The following table provides general information about the 'BP0005. Validate' process. The Business Process Diagram and the description of various business process elements are specified in the following paragraphs.

Description	Reusable subprocess that performs the message validation tasks
Precondition(s)	None
Trigger	The process is triggered when an electronic message is received for validation.
Postcondition(s)	

Business Process Diagram

The Business Process Diagram of 'BP0005. Validate' is shown below in BPMN notation. The definition of a process that might be used as sub-process by the 'BP0005. Validate' can be found in this document. Finally, Annex A of CDEPS-BPS-EXPORT provides some explanatory information about the used notation.

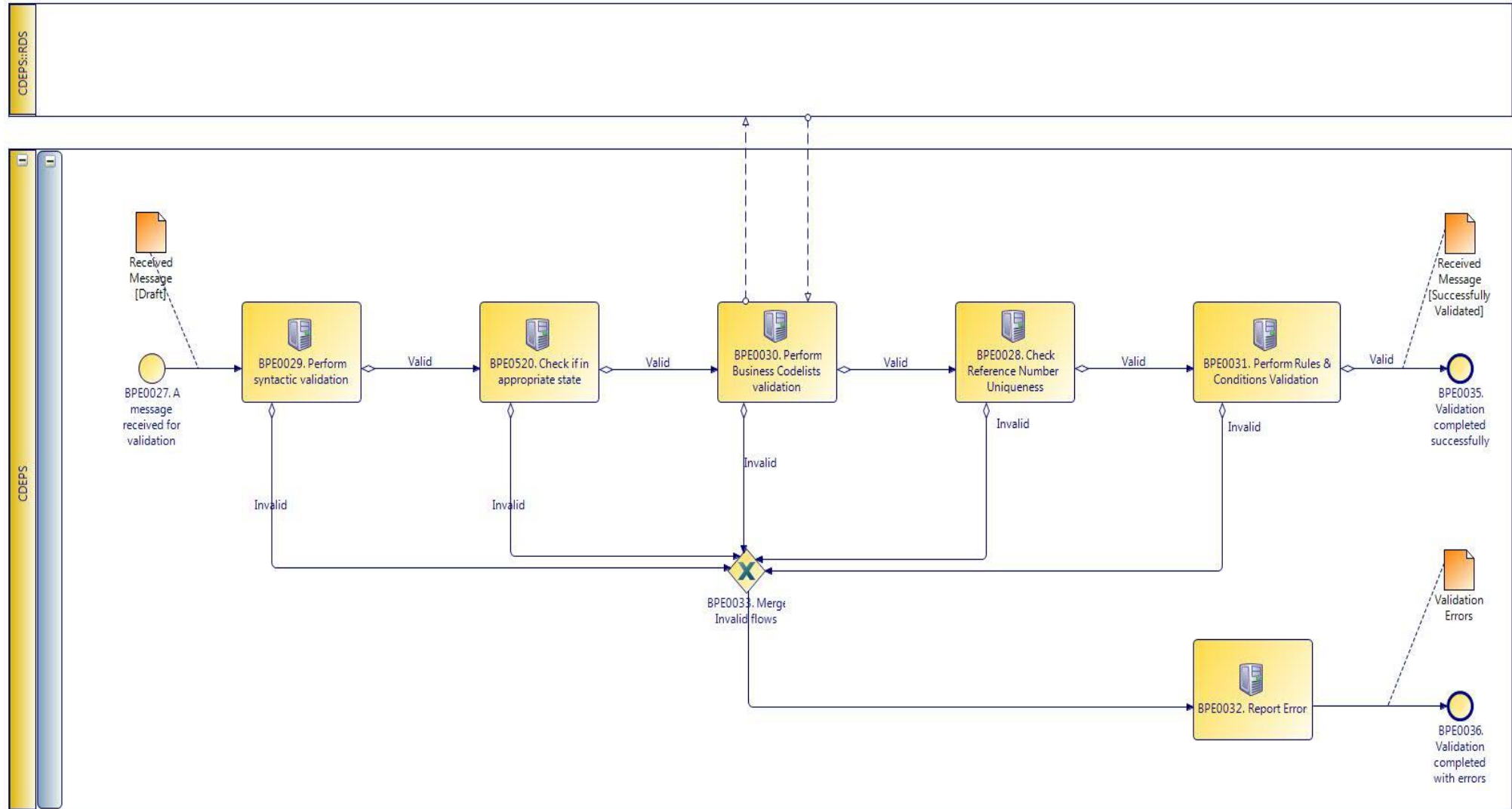

CARM Customs Declaration and Excise Documents Processing system (CDEPS)	REF: CDEPS_EXPORT_BPS
Business Process Specifications for EXPORT System	VER:410

2.11.3.1 Activities

The table below defines the 'Activities' of the 'BP0005. Validate' process.

Element Name	Description	Special Type
BPE0028. Check Reference Number Uniqueness	Check whether message reference numbers are unique in the system.	Service Task
↳ Business Rule 1	<i>Check Message Identification uniqueness</i>	
↳ Business Rule 74	<i>Check Local Reference Number (LRN) uniqueness</i>	
↳ Business Rule 75	<i>Check Movement Reference Number (MRN)uniqueness</i>	
↳ Business Rule 79	<i>Check Manifest reference number uniqueness</i>	
BPE0029. Perform syntactic validation	Check messages against the XSDs.	Service Task
↳ Business Rule 47	<i>Syntactic validation</i>	
BPE0030. Perform Business Codelists validation	Check the message business codelists.	Service Task
↳ Business Rule 50	<i>Business codelist validation against CDEPS:RDS</i>	
BPE0031. Perform Rules & Conditions Validation	Check the rules and conditions of the respective message.	Service Task
BPE0032. Report Errors	Report the identified errors from the validation process. The process terminates.	Service Task
BPE0520. Check if in appropriate state	Check whether the process for the particular entity (e.g. declaration/ application/ document) is on the appropriate state to process the received message. This check shall be performed based on the pertinent State Model of the system.	Service Task
↳ Business Rule 421	<i>Supplementary Declaration validation at Export</i>	
↳ Business Rule 448	<i>Check appropriate state for Export Declaration Amendment</i>	

CARM Customs Declaration and Excise Documents Processing system (CDEPS)	REF: CDEPS_EXPORT_BPS
Business Process Specifications for EXPORT System	VER:410

- ↳ **Business Rule** 449 *Check appropriate state Declaration Goods Presentation*
- ↳ **Business Rule** 468 *Guarantee Amendment*
- ↳ **Business Rule** 492 *Exit control results received at Export*
- ↳ **Business Rule** 493 *Export Declaration request at Export*

2.11.3.2 Event(s)

The table below defines the 'Event(s)' of the 'BP0005. Validate' process.

Element Name	Description	Special Type
BPE0027. A message or event notification from GUI is received for validation	Message input in the validation process.	Start
BPE0035. Validation completed successfully	The validation is completed successfully with no errors reported. The process terminates.	End
BPE0036. Validation completed with errors	The validation completed with errors. The process terminates.	End

2.11.3.3 Gateway(s)

The table below defines the 'Gateway(s)' of the 'BP0005. Validate' process.

Element Name	Description	Special Type
BPE0033. Merge Invalid Flows	Merge into exclusive event based gateway the invalid flows from all validation tasks.	Merge

CARM Customs Declaration and Excise Documents Processing system (CDEPS)	REF: CDEPS_EXPORT_BPS
Business Process Specifications for EXPORT System	VER:410

2.11.4.BP0246. Handle Pre-validation request

Business Process Description

The following table provides general information about the 'BP0246. Handle Pre-validation request' process. The Business Process Diagram and the description of various business process elements are specified in the following paragraphs.

Description	The process handles a request received from the Trader Portal for the pre-validation of any message. The process terminates with either a positive or negative reply back to the Trader Portal.
Precondition(s)	
Trigger	
Postcondition(s)	

Business Process Diagram

The Business Process Diagram of 'BP0246. Handle Pre-validation request' is shown below in BPMN notation. The definition of a process that might be used as sub-process by the 'BP0246. Handle Pre-validation request' can be found in this document. Finally, Annex A of CDEPS-BPS-EXPORT provides some explanatory information about the used notation.

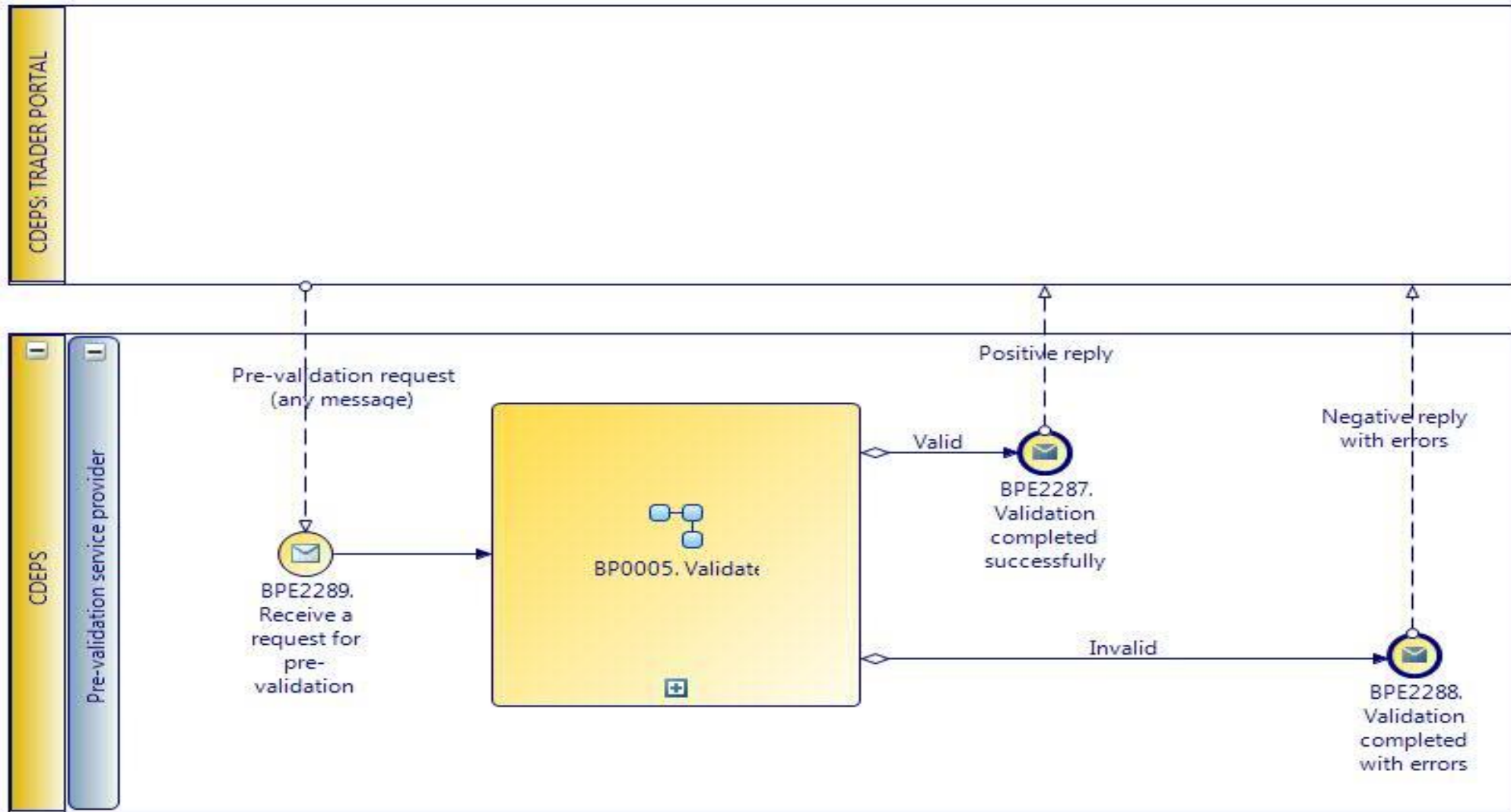

CARM Customs Declaration and Excise Documents Processing system (CDEPS)	REF: CDEPS_EXPORT_BPS
Business Process Specifications for EXPORT System	VER:410

2.11.4.1 Event(s)

The table below defines the 'Event(s)' of the 'BP0246. Handle Pre-validation request' process.

Element Name	Description	Special Type
BPE2287. Validation completed successfully	The validation is completed successfully with no errors reported. The process terminates and informs requesting system accordingly.	End
BPE2288. Validation completed with errors	The validation completed with errors. The process terminates and informs requesting system accordingly.	End
BPE2289. Receive a request for pre-validation	A pre-validation request is received from Trader Portal for a specific message.	Start

CARM Customs Declaration and Excise Documents Processing system (CDEPS)	REF: CDEPS_EXPORT_BPS
Business Process Specifications for EXPORT System	VER:410

2.12. Process Group: Export operation Information Query at any requesting office

2.12.1.BP0145. Process Query Export Operation Information @ Any Requesting Office

Business Process Description

The following table provides general information about the 'BP0145. Process Query Export Operation Information @ Any Requesting Office' process. The Business Process Diagram and the description of various business process elements are specified in the following paragraphs.

Description	A high level process describing the actions performed by the system in order to process query on the Export operation information at any requesting office.
Precondition(s)	None
Trigger	The process is triggered by the action of Customs Officer to request information on an Export operation
Postcondition(s)	None

Business Process Diagram

The Business Process Diagram of 'BP0145. Process Query Export Operation Information @ Any Requesting Office' is shown below in BPMN notation. The definition of a process that might be used as sub-process by the 'BP0145. Process Query Export Operation Information @ Any Requesting Office' can be found in this document. Finally, Annex A of CDEPS-BPS-EXPORT provides some explanatory information about the used notation.

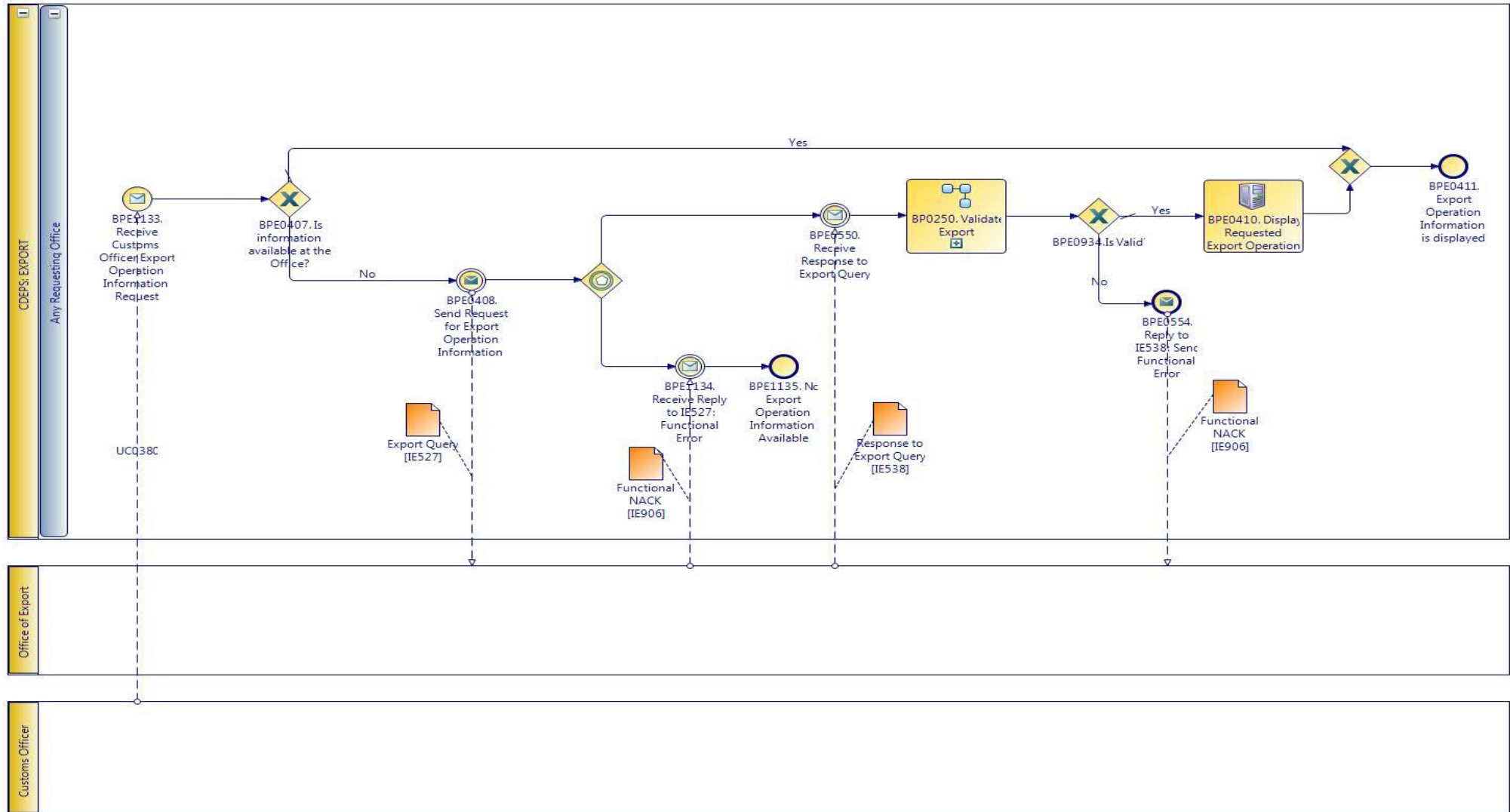

CARM Customs Declaration and Excise Documents Processing system (CDEPS)	REF: CDEPS_EXPORT_BPS
Business Process Specifications for EXPORT System	VER:410

2.12.1.1 Activities

The table below defines the 'Activities' of the 'BP0145. Process Query Export Operation Information @ Any Requesting Office' process.

Element Name	Description	Special Type
BPE0410. Display Requested Export Operation Information	The system displays the received information or the error message.	Service Task

2.12.1.2 Event(s)

The table below defines the 'Event(s)' of the 'BP0145. Process Query Export Operation Information @ Any Requesting Office' process.

Element Name	Description	Special Type
BPE0408. Send Request for Export Operation Information	If the export operation information is not available at the Office where the request is submitted, the system notifies the Customs Officer that the information is not available and automatically sends (IE527) a request to the Country of Export.	Intermediate
BPE0411. Export Operation Information is displayed	The information on the requested export operation is displayed.	End
BPE0550. Receive Response to Export Query	Reception of positive response to the export query	Intermediate
BPE0554. Reply to IE538: Send Functional Error	Send functional error in case of rejection	End
BPE1133. Receive Customs Officer Export Operation Information Request	The system receives the Customs Officer Export Operation Information Request	Start
BPE1134. Receive Reply to IE527: Functional Error	The system receives the reply to IE527: Functional Error	Intermediate

CARM Customs Declaration and Excise Documents Processing system (CDEPS)	REF: CDEPS_EXPORT_BPS
Business Process Specifications for EXPORT System	VER:410

BPE1135. No Export Operation Information Available End

2.12.1.3 Gateway(s)

The table below defines the 'Gateway(s)' of the 'BP0145. Process Query Export Operation Information @ Any Requesting Office' process.

Element Name	Description	Special Type
BPE0407. Is information available at the Office?	The system checks if the export operation information is available at the Office where the request is submitted.	Decision
↳ Business Rule 59	<i>Export/EXS declaration response (IE503/IE603)</i>	
BPE0934. Is Valid?	A decision point in the process to navigate the flow based on the message validation result.	Decision
↳ Business Rule 638	<i>Import declaration type 'X' cannot be cancelled</i>	
↳ Business Rule 646	<i>Guarantees during the registration of Import declaration type 'X'</i>	
↳ Business Rule 80	<i>Valid Message</i>	

CARM Customs Declaration and Excise Documents Processing system (CDEPS)	REF: CDEPS_EXPORT_BPS
Business Process Specifications for EXPORT System	VER:410

2.12.2.BP0250. Validate Export

Business Process Description

The following table provides general information about the 'BP0250. Validate Export' process. The Business Process Diagram and the description of various business process elements are specified in the following paragraphs.

Description	Reusable subprocess that performs the message validation tasks for Export Regime.
Precondition(s)	None
Trigger	The process is triggered when an electronic message is received for validation.
Postcondition(s)	The validation is either completed successfully or with errors reported

Business Process Diagram

The Business Process Diagram of 'BP0250. Validate Export' is shown below in BPMN notation. The definition of a process that might be used as sub-process by the 'BP0250. Validate Export' can be found in this document. Finally, Annex A of CDEPS-BPS-EXPORT provides some explanatory information about the used notation.

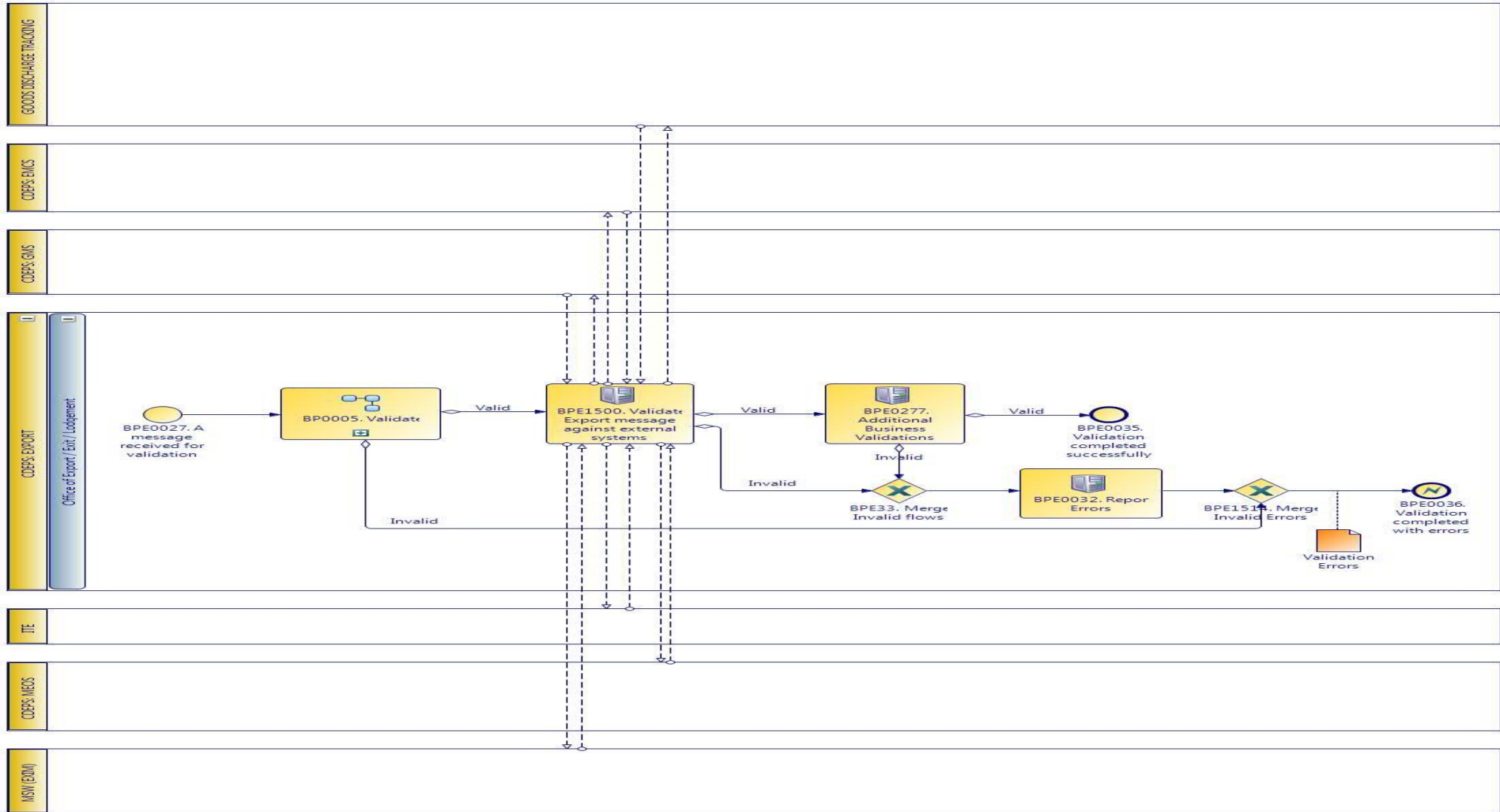

CARM Customs Declaration and Excise Documents Processing system (CDEPS)	REF: CDEPS_EXPORT_BPS
Business Process Specifications for EXPORT System	VER:410

2.12.2.1 Activities

The table below defines the 'Activities' of the 'BP0250. Validate Export' process.

Element Name	Description	Special Type
BPE0032. Report Errors	Report the identified errors from the validation process. The process terminates.	Service Task
BPE0277. Additional Business Validations for Export	The system performs any additional business validations specific to Export System.	Service Task
↳ Business Rule 19	Trader amending data same as Person lodging the declaration	
↳ Business Rule 21	Reject ENS/EXS amendment if ENS/EXS is not in appropriate state	
↳ Business Rule 245	Validate Personal ID	
↳ Business Rule 39	Cancellation Constraint	
↳ Business Rule 520	Import/ Export allowed guarantee types	
↳ Business Rule 70	EXS exists at the Office of Exit	
↳ Business Rule 71	Manifest number in IE547 and IE590	
BPE1500. Validate Export message against external systems	The system performs message validations against external systems.	Service Task
↳ Business Rule 101	Validate Economic Operator against MEOS	
↳ Business Rule 422	Validation of NCTS notifications	
↳ Business Rule 425	Goods Discharge required	
↳ Business Rule 439	Validate against GMS for integrity check	
↳ Business Rule 440	Validate Economic Operator's TIN against MEOS	
↳ Business Rule 494	Orchestrate validation of Export message against external systems	
↳ Business Rule 508	Validation of Export licenses with EXIM	

CARM Customs Declaration and Excise Documents Processing system (CDEPS)	REF: CDEPS_EXPORT_BPS
Business Process Specifications for EXPORT System	VER:410
↳ Business Rule 509	Check Export authorizations with MEOS
↳ Business Rule 51	Validate declared Combined Nomenclature in Declaration against ITE.
↳ Business Rule 510	Check Export authorizations for representation with MEOS
↳ Business Rule 511	Check Evidence of Power of Attorney with MEOS
↳ Business Rule 521	Validate Export declaration against ITE (duty calculation).
↳ Business Rule 522	Validate Export declaration data against Goods Discharge Tracking system
↳ Business Rule 527	Validate Export Declaration data against Excise system

2.12.2.2 Event(s)

The table below defines the 'Event(s)' of the 'BP0250. Validate Export' process.

Element Name	Description	Special Type
BPE0027. A message or event notification from GUI is received for validation	Message input in the validation process.	Start
BPE0035. Validation completed successfully	The validation is completed successfully with no errors reported. The process terminates.	End
BPE0036. Validation completed with errors	The validation completed with errors. The process terminates.	End

2.12.2.3 Gateway(s)

The table below defines the 'Gateway(s)' of the 'BP0250. Validate Export' process.

Element Name	Description	Special Type
BPE1514. Merge Invalid Errors	Combines exclusively either the negative outcome of generic validate process (BP0005. Validate) which reports errors or the errors from the extra checks for the specific system.	Merge

CARM Customs Declaration and Excise Documents Processing system (CDEPS)	REF: CDEPS_EXPORT_BPS
Business Process Specifications for EXPORT System	VER:410

2.12.3.BP0005. Validate

Business Process Description

The following table provides general information about the 'BP0005. Validate' process. The Business Process Diagram and the description of various business process elements are specified in the following paragraphs.

Description	Reusable subprocess that performs the message validation tasks
Precondition(s)	None
Trigger	The process is triggered when an electronic message is received for validation.
Postcondition(s)	

Business Process Diagram

The Business Process Diagram of 'BP0005. Validate' is shown below in BPMN notation. The definition of a process that might be used as sub-process by the 'BP0005. Validate' can be found in this document. Finally, Annex A of CDEPS-BPS-EXPORT provides some explanatory information about the used notation.

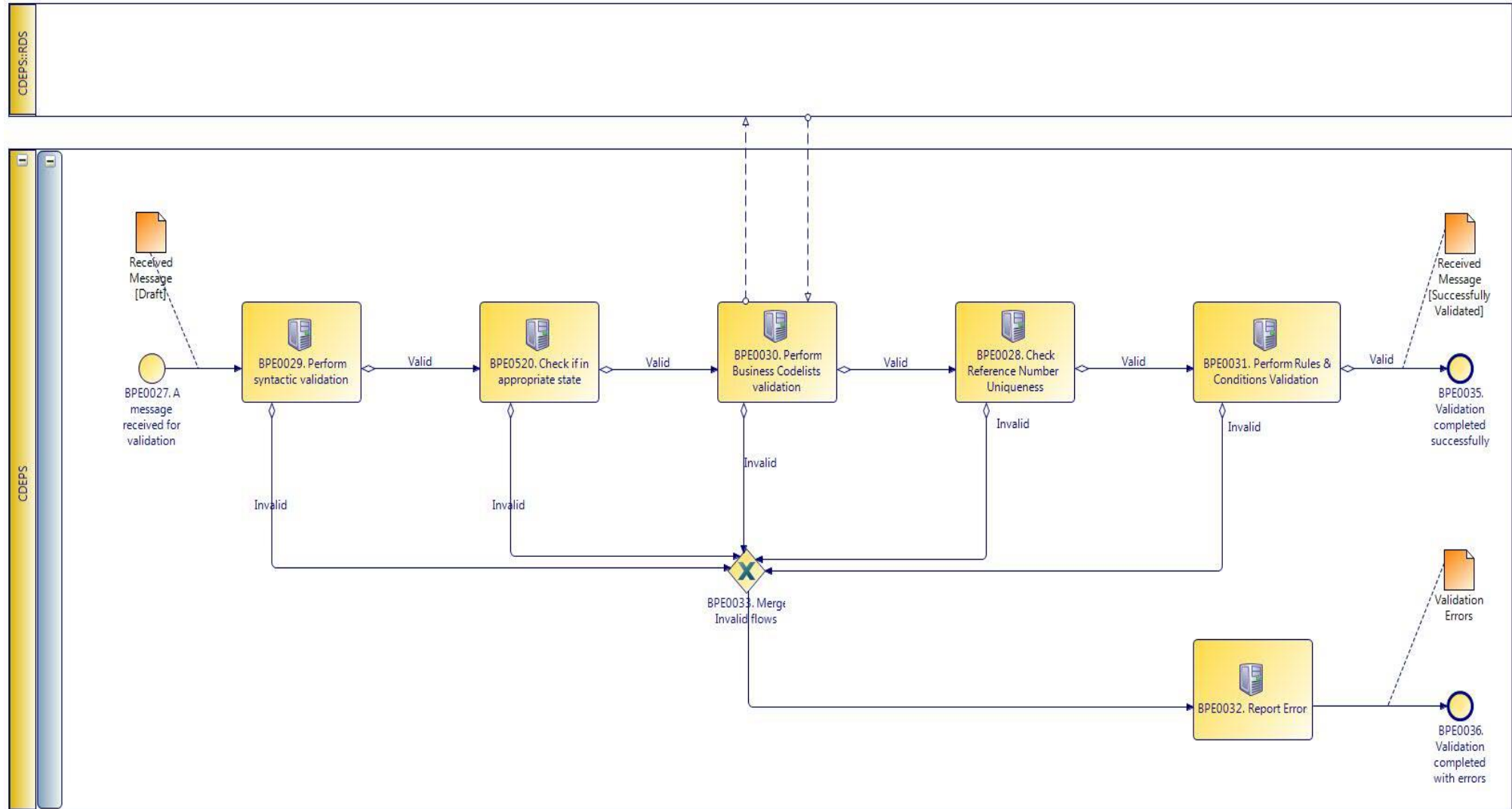

CARM Customs Declaration and Excise Documents Processing system (CDEPS)	REF: CDEPS_EXPORT_BPS
Business Process Specifications for EXPORT System	VER:410

2.12.3.1 Activities

The table below defines the 'Activities' of the 'BP0005. Validate' process.

Element Name	Description	Special Type
BPE0028. Check Reference Number Uniqueness	Check whether message reference numbers are unique in the system.	Service Task
↳ Business Rule 1	<i>Check Message Identification uniqueness</i>	
↳ Business Rule 74	<i>Check Local Reference Number (LRN) uniqueness</i>	
↳ Business Rule 75	<i>Check Movement Reference Number (MRN)uniqueness</i>	
↳ Business Rule 79	<i>Check Manifest reference number uniqueness</i>	
BPE0029. Perform syntactic validation	Check messages against the XSDs.	Service Task
↳ Business Rule 47	<i>Syntactic validation</i>	
BPE0030. Perform Business Codelists validation	Check the message business codelists.	Service Task
↳ Business Rule 50	<i>Business codelist validation against CDEPS:RDS</i>	
BPE0031. Perform Rules & Conditions Validation	Check the rules and conditions of the respective message.	Service Task
BPE0032. Report Errors	Report the identified errors from the validation process. The process terminates.	Service Task
BPE0520. Check if in appropriate state	Check whether the process for the particular entity (e.g. declaration/ application/ document) is on the appropriate state to process the received message. This check shall be performed based on the pertinent State Model of the system.	Service Task
↳ Business Rule 421	<i>Supplementary Declaration validation at Export</i>	
↳ Business Rule 448	<i>Check appropriate state for Export Declaration Amendment</i>	

CARM Customs Declaration and Excise Documents Processing system (CDEPS)	REF: CDEPS_EXPORT_BPS
Business Process Specifications for EXPORT System	VER:410

- ↳ **Business Rule** 449 *Check appropriate state Declaration Goods Presentation*
- ↳ **Business Rule** 468 *Guarantee Amendment*
- ↳ **Business Rule** 492 *Exit control results received at Export*
- ↳ **Business Rule** 493 *Export Declaration request at Export*

2.12.3.2 Event(s)

The table below defines the 'Event(s)' of the 'BP0005. Validate' process.

Element Name	Description	Special Type
BPE0027. A message or event notification from GUI is received for validation	Message input in the validation process.	Start
BPE0035. Validation completed successfully	The validation is completed successfully with no errors reported. The process terminates.	End
BPE0036. Validation completed with errors	The validation completed with errors. The process terminates.	End

2.12.3.3 Gateway(s)

The table below defines the 'Gateway(s)' of the 'BP0005. Validate' process.

Element Name	Description	Special Type
BPE0033. Merge Invalid Flows	Merge into exclusive event based gateway the invalid flows from all validation tasks.	Merge

CARM Customs Declaration and Excise Documents Processing system (CDEPS)	REF: CDEPS_EXPORT_BPS
Business Process Specifications for EXPORT System	VER:410

2.12.4.BP0246. Handle Pre-validation request

Business Process Description

The following table provides general information about the 'BP0246. Handle Pre-validation request' process. The Business Process Diagram and the description of various business process elements are specified in the following paragraphs.

Description	The process handles a request received from the Trader Portal for the pre-validation of any message. The process terminates with either a positive or negative reply back to the Trader Portal.
Precondition(s)	
Trigger	
Postcondition(s)	

Business Process Diagram

The Business Process Diagram of 'BP0246. Handle Pre-validation request' is shown below in BPMN notation. The definition of a process that might be used as sub-process by the 'BP0246. Handle Pre-validation request' can be found in this document. Finally, Annex A of CDEPS-BPS-EXPORT provides some explanatory information about the used notation.

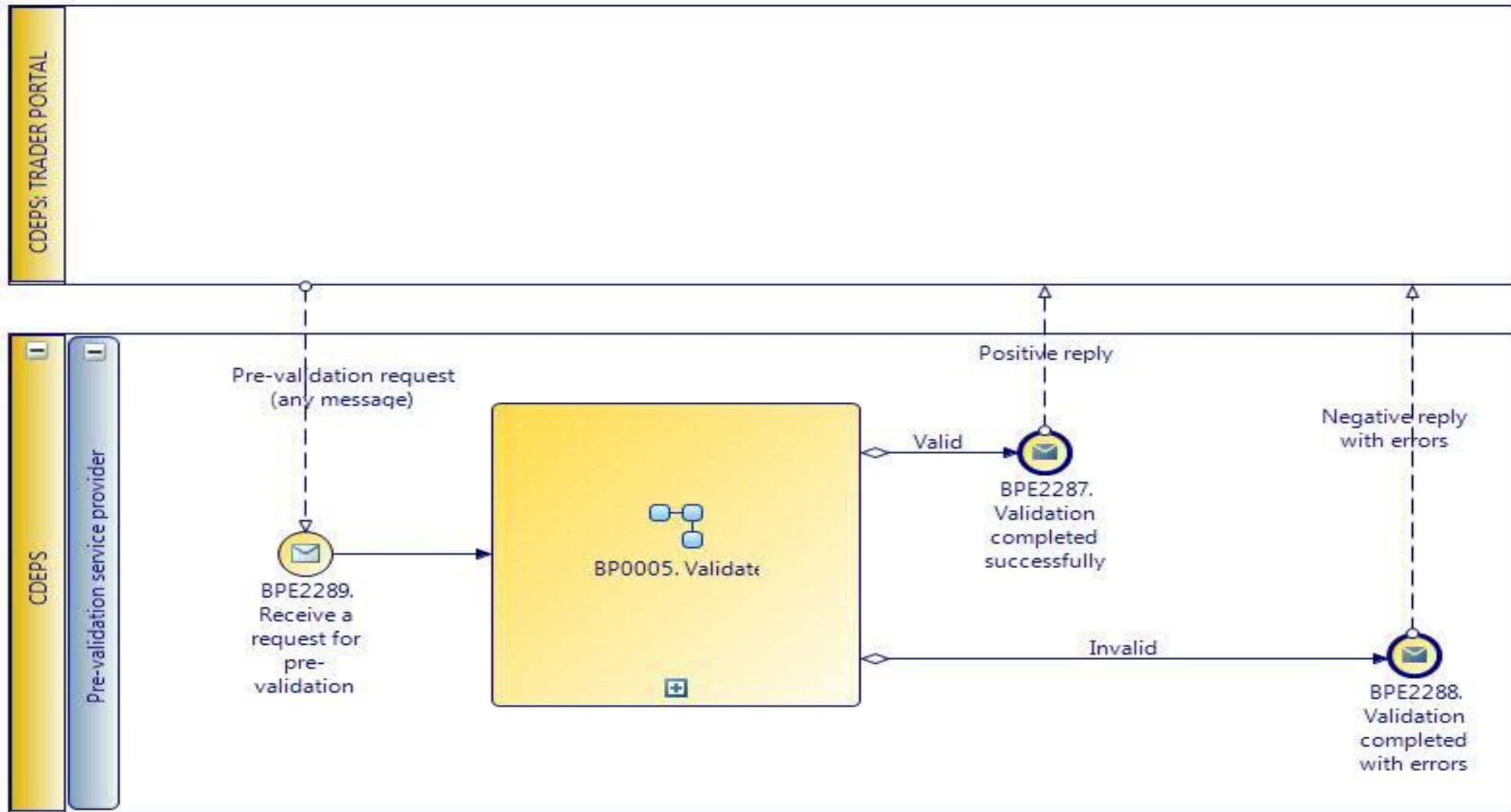

CARM Customs Declaration and Excise Documents Processing system (CDEPS)	REF: CDEPS_EXPORT_BPS
Business Process Specifications for EXPORT System	VER:410

2.12.4.1 Event(s)

The table below defines the 'Event(s)' of the 'BP0246. Handle Pre-validation request' process.

Element Name	Description	Special Type
BPE2287. Validation completed successfully	The validation is completed successfully with no errors reported. The process terminates and informs requesting system accordingly.	End
BPE2288. Validation completed with errors	The validation completed with errors. The process terminates and informs requesting system accordingly.	End
BPE2289. Receive a request for pre-validation	A pre-validation request is received from Trader Portal for a specific message.	Start

CARM Customs Declaration and Excise Documents Processing system (CDEPS)	REF: CDEPS_EXPORT_BPS
Business Process Specifications for EXPORT System	VER:410

2.13. Process Group: Export operation Information Query at Export

2.13.1.BP0144. Process Query Export Operation Information @ Office of Export

Business Process Description

The following table provides general information about the 'BP0144. Process Query Export Operation Information @ Office of Export' process. The Business Process Diagram and the description of various business process elements are specified in the following paragraphs.

Description	A high level process describing the actions performed by the system in order to process query on the Export operation information at the Office of Export.
Precondition(s)	None
Trigger	The process is triggered by the Export Query request received from any requesting Office
Postcondition(s)	None

Business Process Diagram

The Business Process Diagram of 'BP0144. Process Query Export Operation Information @ Office of Export' is shown below in BPMN notation. The definition of a process that might be used as sub-process by the 'BP0144. Process Query Export Operation Information @ Office of Export' can be found in this document. Finally, Annex A of CDEPS-BPS-EXPORT provides some explanatory information about the used notation.

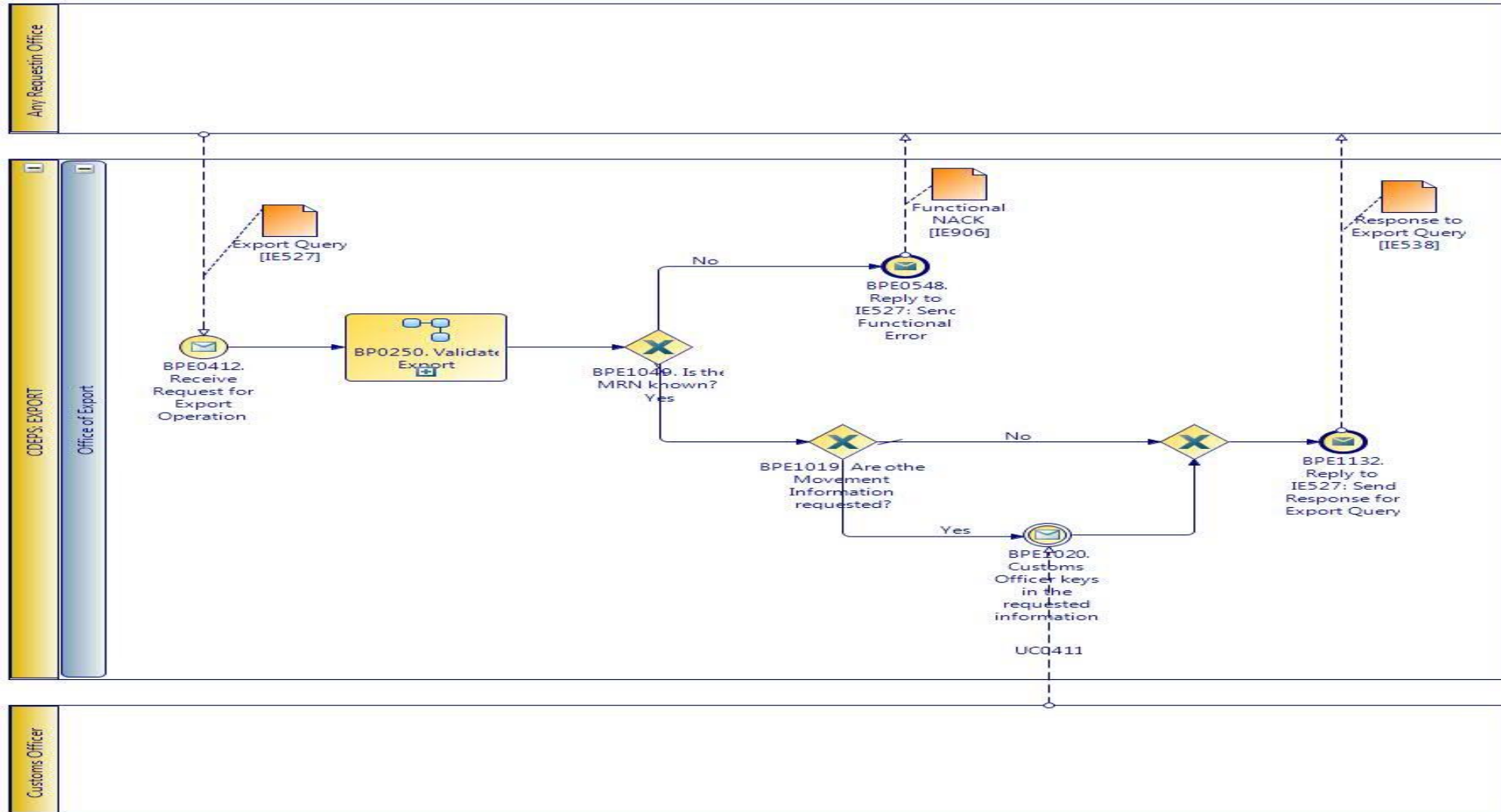

CARM Customs Declaration and Excise Documents Processing system (CDEPS)	REF: CDEPS_EXPORT_BPS
Business Process Specifications for EXPORT System	VER:410

2.13.1.1 Event(s)

The table below defines the 'Event(s)' of the 'BP0144. Process Query Export Operation Information @ Office of Export' process.

Element Name	Description	Special Type
BPE0412. Receive Request for Export Operation	The system in the Country of Export receives a request for export operation information (IE527) from a Customs Office.	Start
BPE0548. Reply to IE527: Send Functional Error	Send functional error in case of rejection	End
BPE1020. Customs Officer keys in the requested information	The Customs Officer keys in the requested information	Intermediate
BPE1132. Reply to IE527: Send Response for Export Query	Reply to IE527: Send Response for Export Query	End

2.13.1.2 Gateway(s)

The table below defines the 'Gateway(s)' of the 'BP0144. Process Query Export Operation Information @ Office of Export' process.

Element Name	Description	Special Type
BPE1019. Are other Movement Information requested?	A decision point in the process to navigate the flow based on whether other Movement Information requested or not	Decision
BPE1049. Is the MRN known?	A check point on the flow to decide whether the MRN brought by the declaration request is known.	Decision

CARM Customs Declaration and Excise Documents Processing system (CDEPS)	REF: CDEPS_EXPORT_BPS
Business Process Specifications for EXPORT System	VER:410

2.13.2.BP0250. Validate Export

Business Process Description

The following table provides general information about the 'BP0250. Validate Export' process. The Business Process Diagram and the description of various business process elements are specified in the following paragraphs.

Description	Reusable subprocess that performs the message validation tasks for Export Regime.
Precondition(s)	None
Trigger	The process is triggered when an electronic message is received for validation.
Postcondition(s)	The validation is either completed successfully or with errors reported

Business Process Diagram

The Business Process Diagram of 'BP0250. Validate Export' is shown below in BPMN notation. The definition of a process that might be used as sub-process by the 'BP0250. Validate Export' can be found in this document. Finally, Annex A of CDEPS-BPS-EXPORT provides some explanatory information about the used notation.

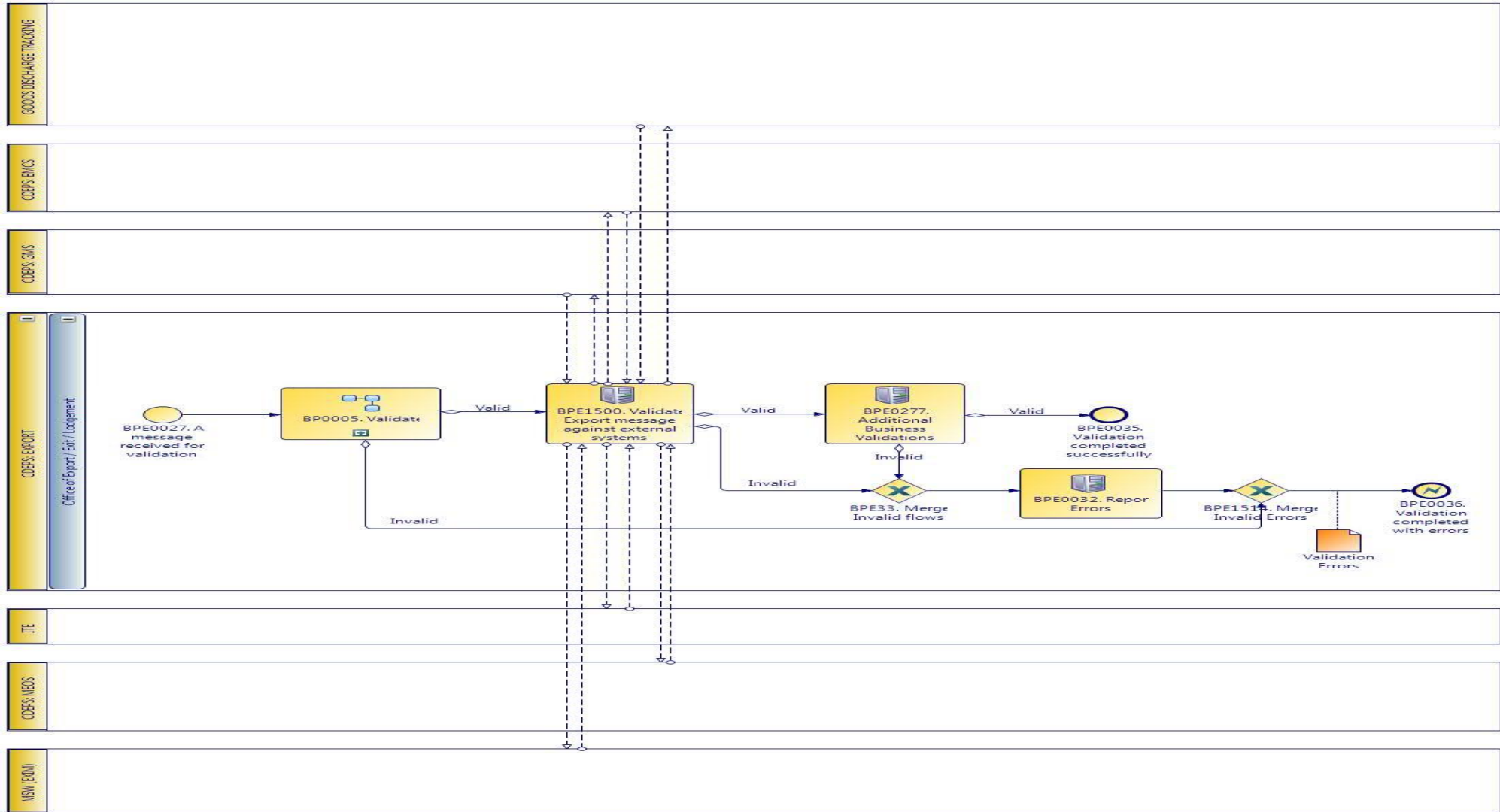

CARM Customs Declaration and Excise Documents Processing system (CDEPS)	REF: CDEPS_EXPORT_BPS
Business Process Specifications for EXPORT System	VER:410

2.13.2.1 Activities

The table below defines the 'Activities' of the 'BP0250. Validate Export' process.

Element Name	Description	Special Type
BPE0032. Report Errors	Report the identified errors from the validation process. The process terminates.	Service Task
BPE0277. Additional Business Validations for Export	The system performs any additional business validations specific to Export System.	Service Task
↳ Business Rule 19	Trader amending data same as Person lodging the declaration	
↳ Business Rule 21	Reject ENS/EXS amendment if ENS/EXS is not in appropriate state	
↳ Business Rule 245	Validate Personal ID	
↳ Business Rule 39	Cancellation Constraint	
↳ Business Rule 520	Import/ Export allowed guarantee types	
↳ Business Rule 70	EXS exists at the Office of Exit	
↳ Business Rule 71	Manifest number in IE547 and IE590	
BPE1500. Validate Export message against external systems	The system performs message validations against external systems.	Service Task
↳ Business Rule 101	Validate Economic Operator against MEOS	
↳ Business Rule 422	Validation of NCTS notifications	
↳ Business Rule 425	Goods Discharge required	
↳ Business Rule 439	Validate against GMS for integrity check	
↳ Business Rule 440	Validate Economic Operator's TIN against MEOS	
↳ Business Rule 494	Orchestrate validation of Export message against external systems	
↳ Business Rule 508	Validation of Export licenses with EXIM	

CARM Customs Declaration and Excise Documents Processing system (CDEPS)	REF: CDEPS_EXPORT_BPS
Business Process Specifications for EXPORT System	VER:410
↳ Business Rule 509	Check Export authorizations with MEOS
↳ Business Rule 51	Validate declared Combined Nomenclature in Declaration against ITE.
↳ Business Rule 510	Check Export authorizations for representation with MEOS
↳ Business Rule 511	Check Evidence of Power of Attorney with MEOS
↳ Business Rule 521	Validate Export declaration against ITE (duty calculation).
↳ Business Rule 522	Validate Export declaration data against Goods Discharge Tracking system
↳ Business Rule 527	Validate Export Declaration data against Excise system

2.13.2.2 Event(s)

The table below defines the 'Event(s)' of the 'BP0250. Validate Export' process.

Element Name	Description	Special Type
BPE0027. A message or event notification from GUI is received for validation	Message input in the validation process.	Start
BPE0035. Validation completed successfully	The validation is completed successfully with no errors reported. The process terminates.	End
BPE0036. Validation completed with errors	The validation completed with errors. The process terminates.	End

2.13.2.3 Gateway(s)

The table below defines the 'Gateway(s)' of the 'BP0250. Validate Export' process.

Element Name	Description	Special Type
BPE1514. Merge Invalid Errors	Combines exclusively either the negative outcome of generic validate process (BP0005. Validate) which reports errors or the errors from the extra checks for the specific system.	Merge

CARM Customs Declaration and Excise Documents Processing system (CDEPS)	REF: CDEPS_EXPORT_BPS
Business Process Specifications for EXPORT System	VER:410

2.13.3.BP0005. Validate

Business Process Description

The following table provides general information about the 'BP0005. Validate' process. The Business Process Diagram and the description of various business process elements are specified in the following paragraphs.

Description	Reusable subprocess that performs the message validation tasks
Precondition(s)	None
Trigger	The process is triggered when an electronic message is received for validation.
Postcondition(s)	

Business Process Diagram

The Business Process Diagram of 'BP0005. Validate' is shown below in BPMN notation. The definition of a process that might be used as sub-process by the 'BP0005. Validate' can be found in this document. Finally, Annex A of CDEPS-BPS-EXPORT provides some explanatory information about the used notation.

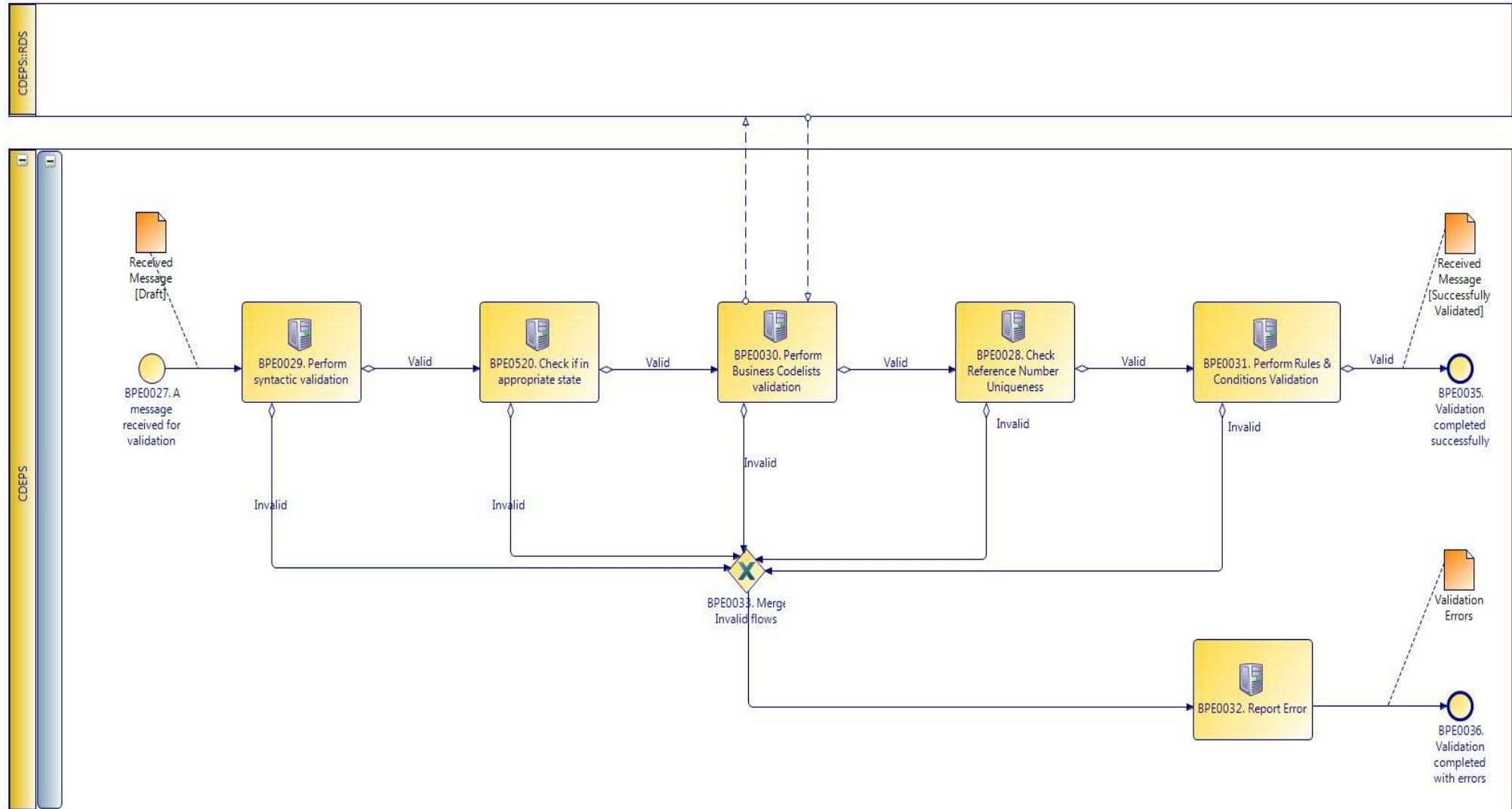

CARM Customs Declaration and Excise Documents Processing system (CDEPS)	REF: CDEPS_EXPORT_BPS
Business Process Specifications for EXPORT System	VER:410

2.13.3.1 Activities

The table below defines the 'Activities' of the 'BP0005. Validate' process.

Element Name	Description	Special Type
BPE0028. Check Reference Number Uniqueness	Check whether message reference numbers are unique in the system.	Service Task
↳ Business Rule 1	<i>Check Message Identification uniqueness</i>	
↳ Business Rule 74	<i>Check Local Reference Number (LRN) uniqueness</i>	
↳ Business Rule 75	<i>Check Movement Reference Number (MRN)uniqueness</i>	
↳ Business Rule 79	<i>Check Manifest reference number uniqueness</i>	
BPE0029. Perform syntactic validation	Check messages against the XSDs.	Service Task
↳ Business Rule 47	<i>Syntactic validation</i>	
BPE0030. Perform Business Codelists validation	Check the message business codelists.	Service Task
↳ Business Rule 50	<i>Business codelist validation against CDEPS:RDS</i>	
BPE0031. Perform Rules & Conditions Validation	Check the rules and conditions of the respective message.	Service Task
BPE0032. Report Errors	Report the identified errors from the validation process. The process terminates.	Service Task
BPE0520. Check if in appropriate state	Check whether the process for the particular entity (e.g. declaration/ application/ document) is on the appropriate state to process the received message. This check shall be performed based on the pertinent State Model of the system.	Service Task
↳ Business Rule 421	<i>Supplementary Declaration validation at Export</i>	
↳ Business Rule 448	<i>Check appropriate state for Export Declaration Amendment</i>	

CARM Customs Declaration and Excise Documents Processing system (CDEPS)	REF: CDEPS_EXPORT_BPS
Business Process Specifications for EXPORT System	VER:410

- ↳ **Business Rule** 449 *Check appropriate state Declaration Goods Presentation*
- ↳ **Business Rule** 468 *Guarantee Amendment*
- ↳ **Business Rule** 492 *Exit control results received at Export*
- ↳ **Business Rule** 493 *Export Declaration request at Export*

2.13.3.2 Event(s)

The table below defines the 'Event(s)' of the 'BP0005. Validate' process.

Element Name	Description	Special Type
BPE0027. A message or event notification from GUI is received for validation	Message input in the validation process.	Start
BPE0035. Validation completed successfully	The validation is completed successfully with no errors reported. The process terminates.	End
BPE0036. Validation completed with errors	The validation completed with errors. The process terminates.	End

2.13.3.3 Gateway(s)

The table below defines the 'Gateway(s)' of the 'BP0005. Validate' process.

Element Name	Description	Special Type
BPE0033. Merge Invalid Flows	Merge into exclusive event based gateway the invalid flows from all validation tasks.	Merge

CARM Customs Declaration and Excise Documents Processing system (CDEPS)	REF: CDEPS_EXPORT_BPS
Business Process Specifications for EXPORT System	VER:410

2.13.4.BP0246. Handle Pre-validation request

Business Process Description

The following table provides general information about the 'BP0246. Handle Pre-validation request' process. The Business Process Diagram and the description of various business process elements are specified in the following paragraphs.

Description	The process handles a request received from the Trader Portal for the pre-validation of any message. The process terminates with either a positive or negative reply back to the Trader Portal.
--------------------	---

Precondition(s)	
------------------------	--

Trigger	
----------------	--

Postcondition(s)	
-------------------------	--

Business Process Diagram

The Business Process Diagram of 'BP0246. Handle Pre-validation request' is shown below in BPMN notation. The definition of a process that might be used as sub-process by the 'BP0246. Handle Pre-validation request' can be found in this document. Finally, Annex A of CDEPS-BPS-EXPORT provides some explanatory information about the used notation.

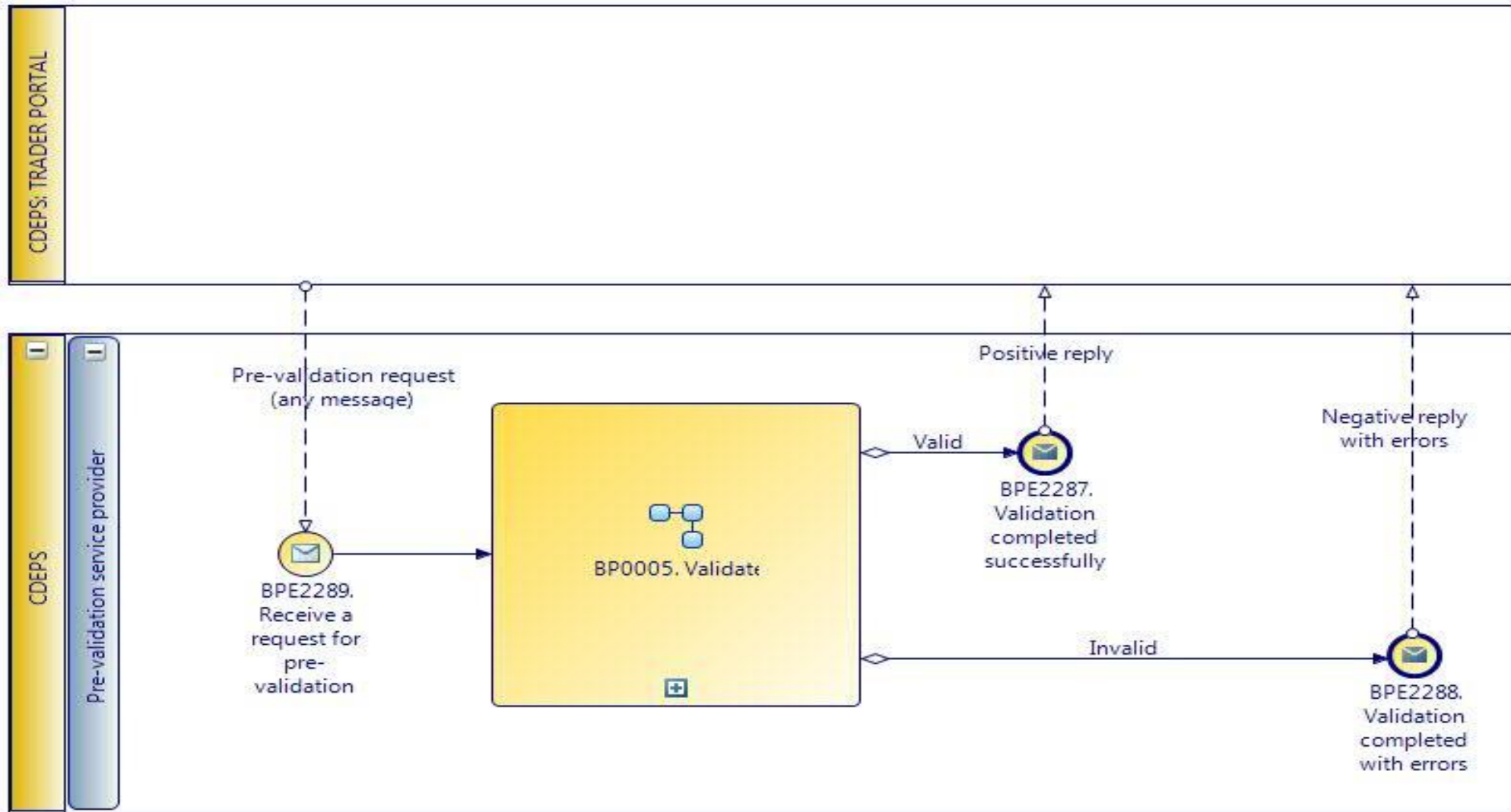

CARM Customs Declaration and Excise Documents Processing system (CDEPS)	REF: CDEPS_EXPORT_BPS
Business Process Specifications for EXPORT System	VER:410

2.13.4.1 Event(s)

The table below defines the 'Event(s)' of the 'BP0246. Handle Pre-validation request' process.

Element Name	Description	Special Type
BPE2287. Validation completed successfully	The validation is completed successfully with no errors reported. The process terminates and informs requesting system accordingly.	End
BPE2288. Validation completed with errors	The validation completed with errors. The process terminates and informs requesting system accordingly.	End
BPE2289. Receive a request for pre-validation	A pre-validation request is received from Trader Portal for a specific message.	Start

CARM Customs Declaration and Excise Documents Processing system (CDEPS)	REF: CDEPS_EXPORT_BPS
Business Process Specifications for EXPORT System	VER:410

2.14. Process Group: Processing Movement Status at Export

2.14.1.BP0583. Request Movement Status at Export

Business Process Description

The following table provides general information about the 'BP0583. Request Movement Status at Export' process. The Business Process Diagram and the description of various business process elements are specified in the following paragraphs.

Description	This process describes the actions performed by the system in order to process the movement status request to the Office of Exit.
Precondition(s)	Any state following the Release for Export
Trigger	The process is triggered when the follow - up timer expires or the customs officer initiates the sending of a status request.
Postcondition(s)	None

Business Process Diagram

The Business Process Diagram of 'BP0583. Request Movement Status at Export' is shown below in BPMN notation. The definition of a process that might be used as sub-process by the 'BP0583. Request Movement Status at Export' can be found in this document. Finally, Annex A of CDEPS-BPS-EXPORT provides some explanatory information about the used notation.

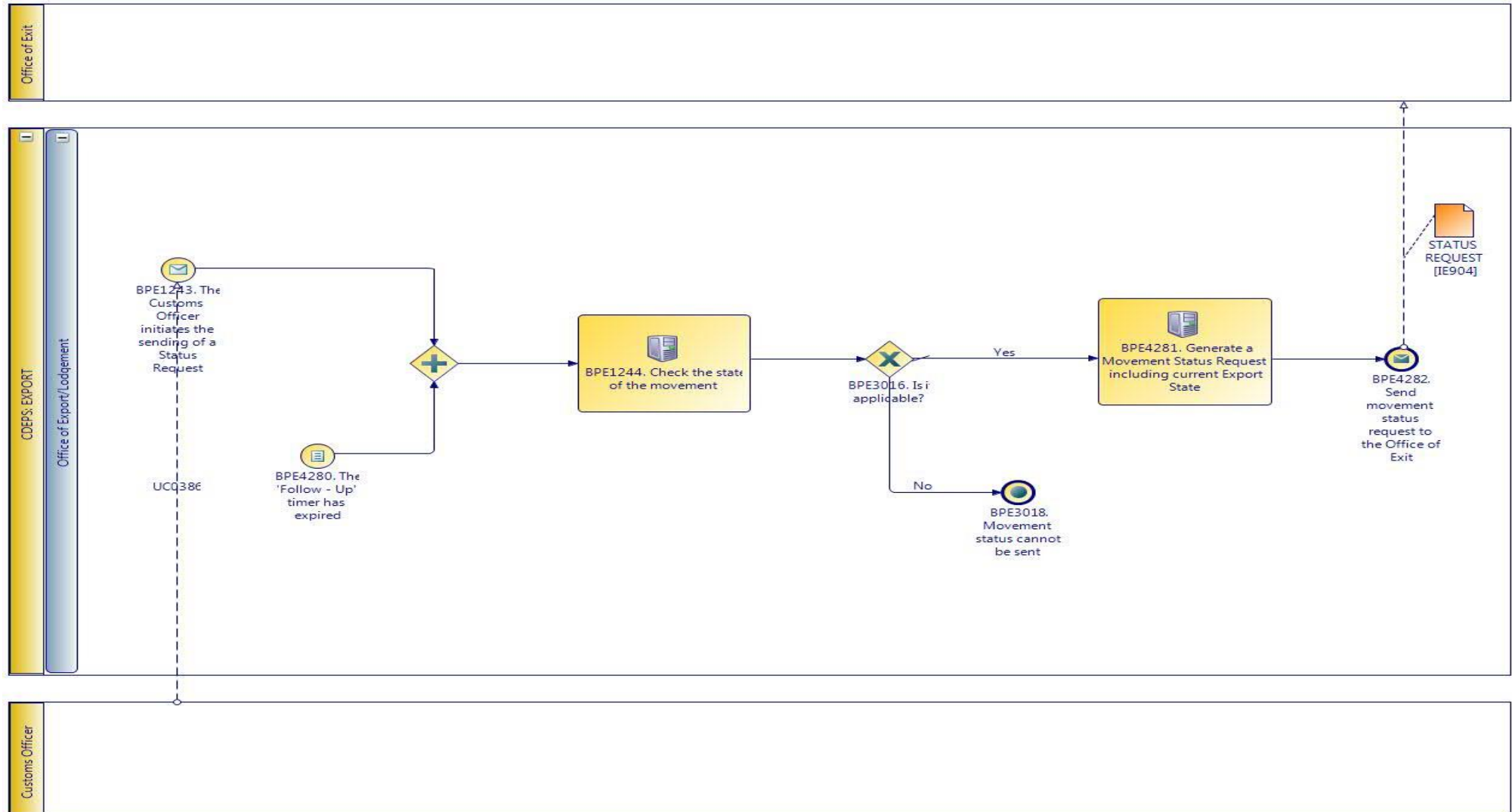

CARM Customs Declaration and Excise Documents Processing system (CDEPS)	REF: CDEPS_EXPORT_BPS
Business Process Specifications for EXPORT System	VER:410

2.14.1.1 Activities

The table below defines the 'Activities' of the 'BP0583. Request Movement Status at Export' process.

Element Name	Description	Special Type
BPE1244. Check the state of the movement	System checks if movement state at Departure is under allowed states for status request to be sent.	Service Task
BPE4281. Generate a Movement Status Request including current Export State	The System generates a Movement Status Request including current Export State	Service Task

2.14.1.2 Event(s)

The table below defines the 'Event(s)' of the 'BP0583. Request Movement Status at Export' process.

Element Name	Description	Special Type
BPE1243. The Customs Officer initiates the sending of a Status Request	Customs Officer decides to manually request movement status	Start
BPE3018. Movement status cannot be sent	Local movement state is not applicable	End
BPE4280. The 'Follow - Up' timer has expired	The 'Follow - Up' timer has expired	Start
BPE4282. Send movement status request to the Office of Exit	The System sends the movement status request to the Office of Exit	End

CARM Customs Declaration and Excise Documents Processing system (CDEPS)	REF: CDEPS_EXPORT_BPS
Business Process Specifications for EXPORT System	VER:410

2.14.1.3 Gateway(s)

The table below defines the 'Gateway(s)' of the 'BP0583. Request Movement Status at Export' process.

Element Name	Description	Special Type
BPE3016. Is it applicable?	Is departure movement state applicable?	Decision

CARM Customs Declaration and Excise Documents Processing system (CDEPS)	REF: CDEPS_EXPORT_BPS
Business Process Specifications for EXPORT System	VER:410

2.14.2.BP0584. Response to Movement Status Request

Business Process Description

The following table provides general information about the 'BP0584. Response to Movement Status Request' process. The Business Process Diagram and the description of various business process elements are specified in the following paragraphs.

Description	The process describes the actions performed by the System at Office of Exit in order to response to the movement status request received from Office of Exit
Precondition(s)	None
Trigger	The process is triggered by the Status Request received from the Office of Export
Postcondition(s)	None

Business Process Diagram

The Business Process Diagram of 'BP0584. Response to Movement Status Request' is shown below in BPMN notation. The definition of a process that might be used as sub-process by the 'BP0584. Response to Movement Status Request' can be found in this document. Finally, Annex A of CDEPS-BPS-EXPORT provides some explanatory information about the used notation.

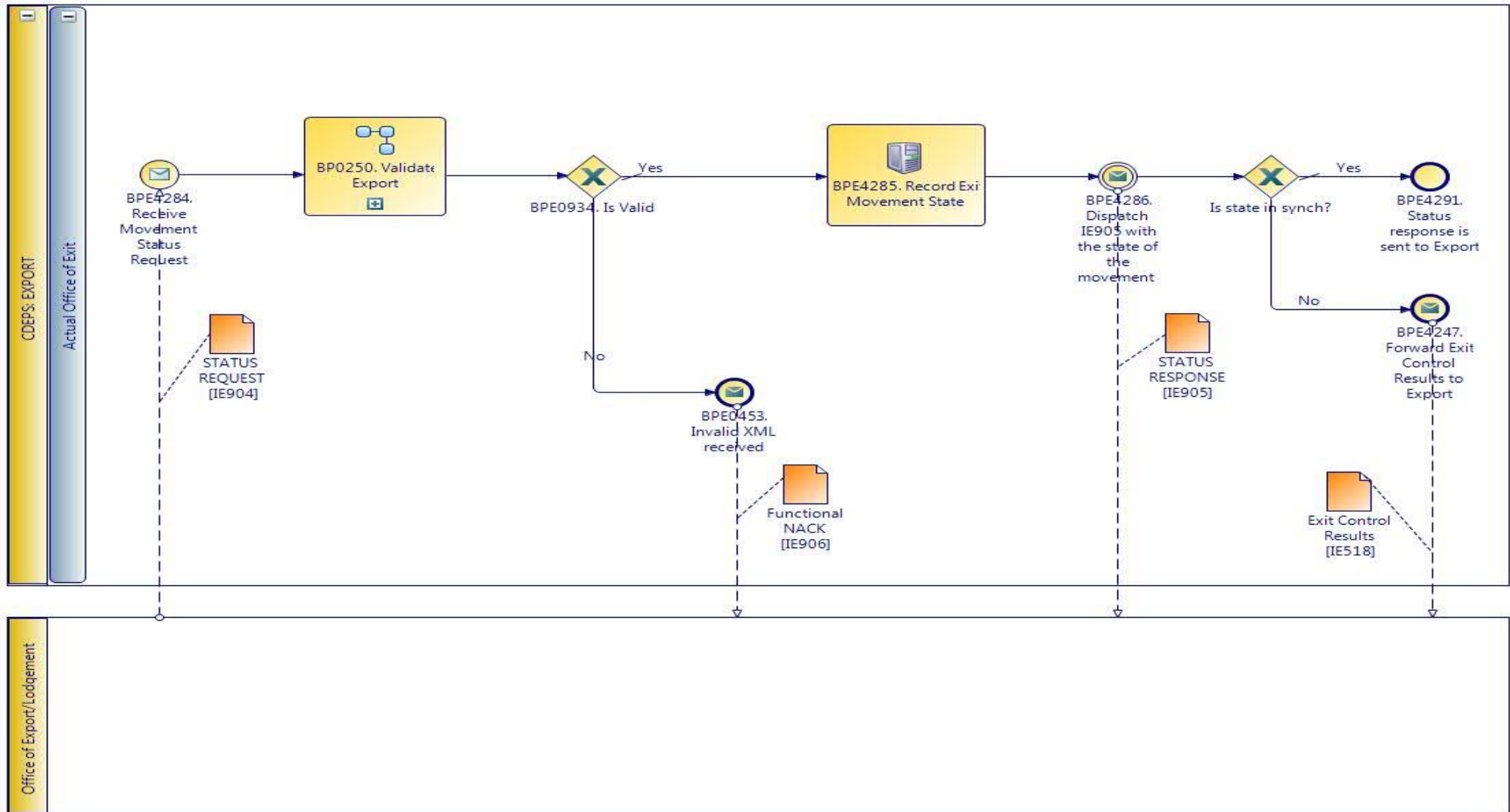

CARM Customs Declaration and Excise Documents Processing system (CDEPS)	REF: CDEPS_EXPORT_BPS
Business Process Specifications for EXPORT System	VER:410

2.14.2.1 Activities

The table below defines the 'Activities' of the 'BP0584. Response to Movement Status Request' process.

Element Name	Description	Special Type
BPE4285. Record Exit Movement State	The system records the Exit Movement State	Service Task

2.14.2.2 Event(s)

The table below defines the 'Event(s)' of the 'BP0584. Response to Movement Status Request' process.

Element Name	Description	Special Type
BPE0453. Invalid XML received	The process ends with result Invalid XML received.	End
BPE4247. Forward Exit Control Results to Export	The System forwards the Exit Control Results to Export	End
BPE4284. Receive Movement Status Request	The System receives the movement status request	Start
BPE4286. Dispatch IE905 with the state of the movement	The system dispatches the IE905 with the state of the movement	End
BPE4291. Status response is sent to Export	The Status response is sent to Export	End

2.14.2.3 Gateway(s)

The table below defines the 'Gateway(s)' of the 'BP0584. Response to Movement Status Request' process.

Element Name	Description	Special Type
BPE0934. Is Valid?	A decision point in the process to navigate the flow based on the message validation result.	Decision

↳ **Business Rule** 638 *Import declaration type 'X' cannot be cancelled*

CARM Customs Declaration and Excise Documents Processing system (CDEPS)	REF: CDEPS_EXPORT_BPS
Business Process Specifications for EXPORT System	VER:410
↳ Business Rule 646	<i>Guarantees during the registration of Import declaration type 'X'</i>
↳ Business Rule 80	<i>Valid Message</i>

CARM Customs Declaration and Excise Documents Processing system (CDEPS)	REF: CDEPS_EXPORT_BPS
Business Process Specifications for EXPORT System	VER:410

2.14.3.BP0585. Handle Movement Status Response

Business Process Description

The following table provides general information about the 'BP0585. Handle Movement Status Response' process. The Business Process Diagram and the description of various business process elements are specified in the following paragraphs.

Description	The process describes the actions performed by the System at Office of Export in order to handle the movement status received from Office of Exit
Precondition(s)	The movement is at any state following the released for export state and a status request has been sent
Trigger	The process is triggered by the movement status response received from Office of Exit
Postcondition(s)	None

Business Process Diagram

The Business Process Diagram of 'BP0585. Handle Movement Status Response' is shown below in BPMN notation. The definition of a process that might be used as sub-process by the 'BP0585. Handle Movement Status Response' can be found in this document. Finally, Annex A of CDEPS-BPS-EXPORT provides some explanatory information about the used notation.

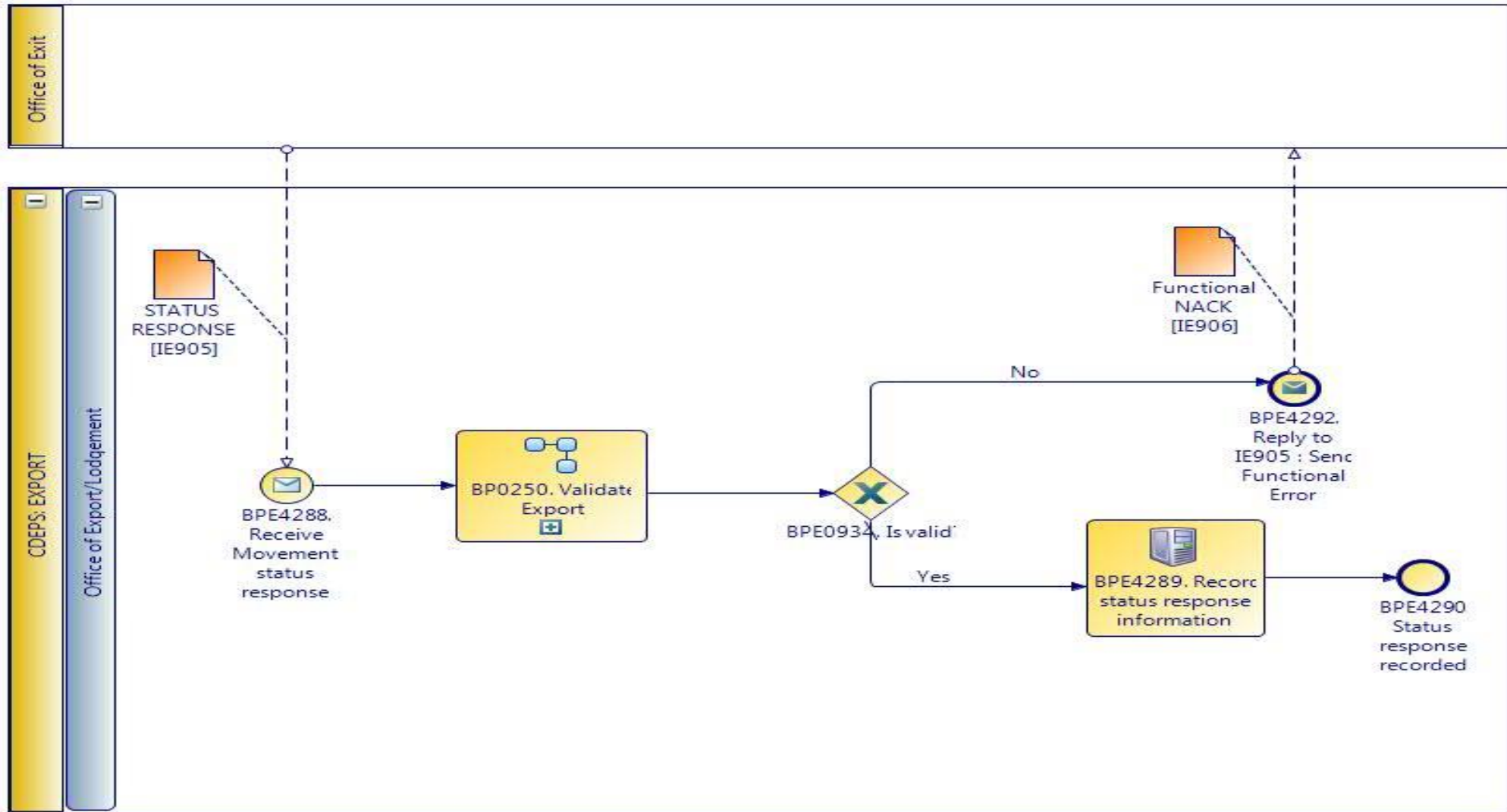

CARM Customs Declaration and Excise Documents Processing system (CDEPS)	REF: CDEPS_EXPORT_BPS
Business Process Specifications for EXPORT System	VER:410

2.14.3.1 Activities

The table below defines the 'Activities' of the 'BP0585. Handle Movement Status Response' process.

Element Name	Description	Special Type
BPE4289. Record status response information	The information on the movement status is recorded into the system	Service Task

2.14.3.2 Event(s)

The table below defines the 'Event(s)' of the 'BP0585. Handle Movement Status Response' process.

Element Name	Description	Special Type
BPE4288. Receive Movement status response	The system receives the Movement status response from Office of Exit	Start
BPE4290. Status response recorded	Status response recorded	End
BPE4292. Reply to IE905 : Send Functional Error	Reply to IE905 : Send Functional Error	End

2.14.3.3 Gateway(s)

The table below defines the 'Gateway(s)' of the 'BP0585. Handle Movement Status Response' process.

Element Name	Description	Special Type
BPE0934. Is Valid?	A decision point in the process to navigate the flow based on the message validation result.	Decision
↳ Business Rule	638 <i>Import declaration type 'X' cannot be cancelled</i>	
↳ Business Rule	646 <i>Guarantees during the registration of Import declaration type 'X'</i>	
↳ Business Rule	80 <i>Valid Message</i>	

CARM Customs Declaration and Excise Documents Processing system (CDEPS)	REF: CDEPS_EXPORT_BPS
Business Process Specifications for EXPORT System	VER:410

2.14.4.BP0250. Validate Export

Business Process Description

The following table provides general information about the 'BP0250. Validate Export' process. The Business Process Diagram and the description of various business process elements are specified in the following paragraphs.

Description	Reusable subprocess that performs the message validation tasks for Export Regime.
Precondition(s)	None
Trigger	The process is triggered when an electronic message is received for validation.
Postcondition(s)	The validation is either completed successfully or with errors reported

Business Process Diagram

The Business Process Diagram of 'BP0250. Validate Export' is shown below in BPMN notation. The definition of a process that might be used as sub-process by the 'BP0250. Validate Export' can be found in this document. Finally, Annex A of CDEPS-BPS-EXPORT provides some explanatory information about the used notation.

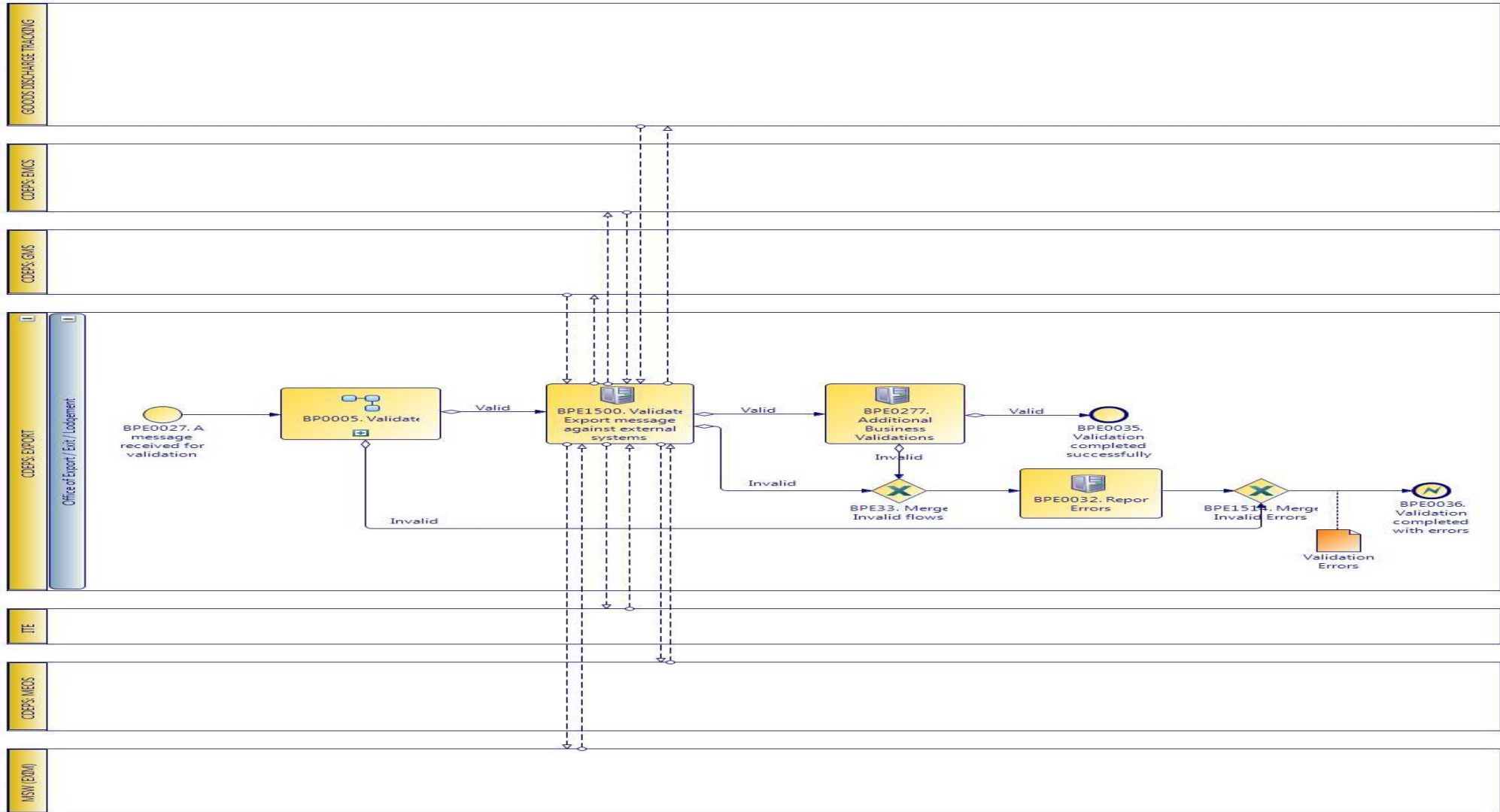

CARM Customs Declaration and Excise Documents Processing system (CDEPS)	REF: CDEPS_EXPORT_BPS
Business Process Specifications for EXPORT System	VER:410

2.14.4.1 Activities

The table below defines the 'Activities' of the 'BP0250. Validate Export' process.

Element Name	Description	Special Type
BPE0032. Report Errors	Report the identified errors from the validation process. The process terminates.	Service Task
BPE0277. Additional Business Validations for Export	The system performs any additional business validations specific to Export System.	Service Task
↳ Business Rule 19	Trader amending data same as Person lodging the declaration	
↳ Business Rule 21	Reject ENS/EXS amendment if ENS/EXS is not in appropriate state	
↳ Business Rule 245	Validate Personal ID	
↳ Business Rule 39	Cancellation Constraint	
↳ Business Rule 520	Import/ Export allowed guarantee types	
↳ Business Rule 70	EXS exists at the Office of Exit	
↳ Business Rule 71	Manifest number in IE547 and IE590	
BPE1500. Validate Export message against external systems	The system performs message validations against external systems.	Service Task
↳ Business Rule 101	Validate Economic Operator against MEOS	
↳ Business Rule 422	Validation of NCTS notifications	
↳ Business Rule 425	Goods Discharge required	
↳ Business Rule 439	Validate against GMS for integrity check	
↳ Business Rule 440	Validate Economic Operator's TIN against MEOS	
↳ Business Rule 494	Orchestrate validation of Export message against external systems	
↳ Business Rule 508	Validation of Export licenses with EXIM	

CARM Customs Declaration and Excise Documents Processing system (CDEPS)	REF: CDEPS_EXPORT_BPS
Business Process Specifications for EXPORT System	VER:410
↳ Business Rule 509	Check Export authorizations with MEOS
↳ Business Rule 51	Validate declared Combined Nomenclature in Declaration against ITE.
↳ Business Rule 510	Check Export authorizations for representation with MEOS
↳ Business Rule 511	Check Evidence of Power of Attorney with MEOS
↳ Business Rule 521	Validate Export declaration against ITE (duty calculation).
↳ Business Rule 522	Validate Export declaration data against Goods Discharge Tracking system
↳ Business Rule 527	Validate Export Declaration data against Excise system

2.14.4.2 Event(s)

The table below defines the 'Event(s)' of the 'BP0250. Validate Export' process.

Element Name	Description	Special Type
BPE0027. A message or event notification from GUI is received for validation	Message input in the validation process.	Start
BPE0035. Validation completed successfully	The validation is completed successfully with no errors reported. The process terminates.	End
BPE0036. Validation completed with errors	The validation completed with errors. The process terminates.	End

2.14.4.3 Gateway(s)

The table below defines the 'Gateway(s)' of the 'BP0250. Validate Export' process.

Element Name	Description	Special Type
BPE1514. Merge Invalid Errors	Combines exclusively either the negative outcome of generic validate process (BP0005. Validate) which reports errors or the errors from the extra checks for the specific system.	Merge

CARM Customs Declaration and Excise Documents Processing system (CDEPS)	REF: CDEPS_EXPORT_BPS
Business Process Specifications for EXPORT System	VER:410

2.14.5.BP0005. Validate

Business Process Description

The following table provides general information about the 'BP0005. Validate' process. The Business Process Diagram and the description of various business process elements are specified in the following paragraphs.

Description	Reusable subprocess that performs the message validation tasks
Precondition(s)	None
Trigger	The process is triggered when an electronic message is received for validation.
Postcondition(s)	

Business Process Diagram

The Business Process Diagram of 'BP0005. Validate' is shown below in BPMN notation. The definition of a process that might be used as sub-process by the 'BP0005. Validate' can be found in this document. Finally, Annex A of CDEPS-BPS-EXPORT provides some explanatory information about the used notation.

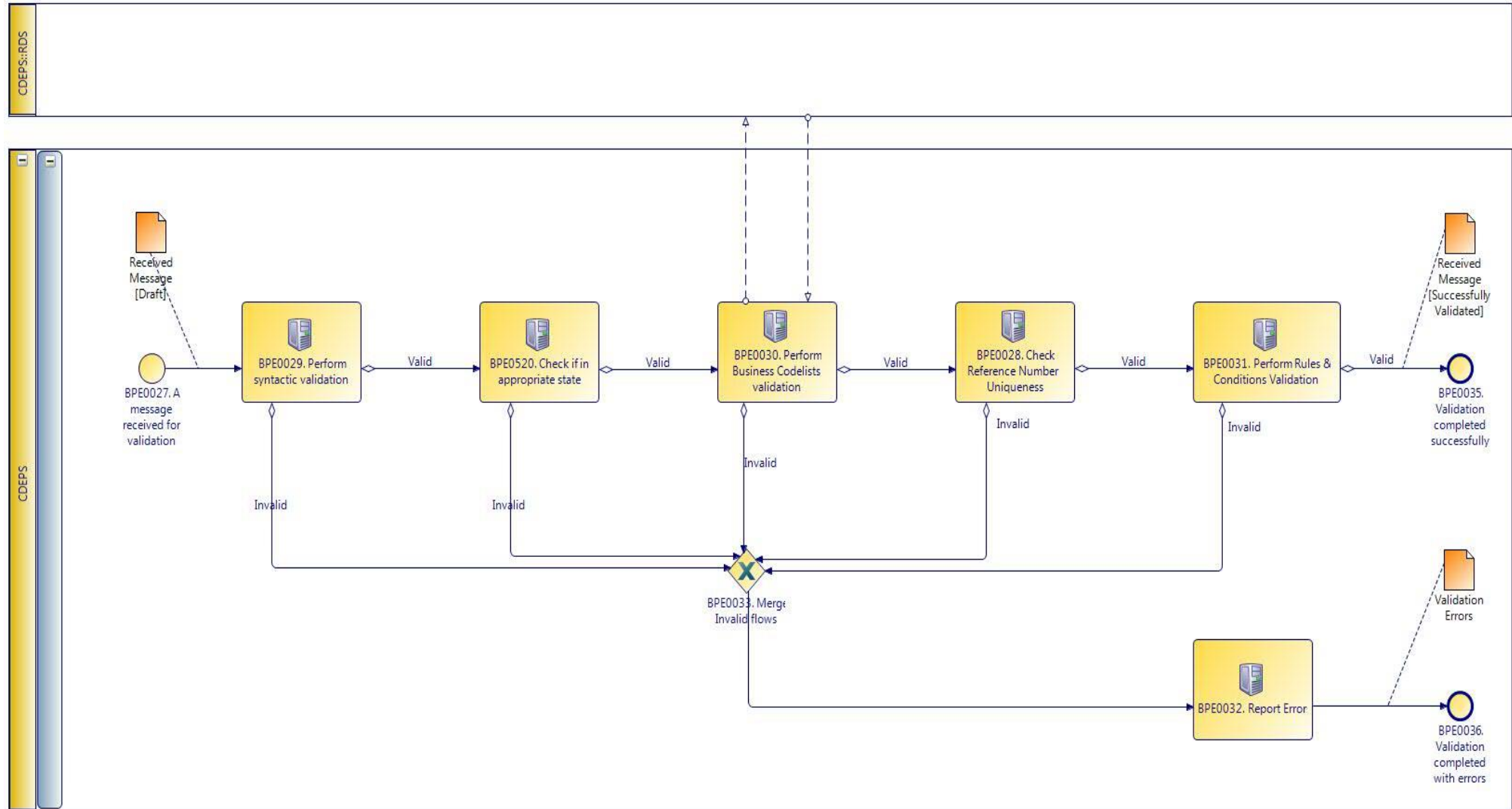

CARM Customs Declaration and Excise Documents Processing system (CDEPS)	REF: CDEPS_EXPORT_BPS
Business Process Specifications for EXPORT System	VER:410

2.14.5.1 Activities

The table below defines the 'Activities' of the 'BP0005. Validate' process.

Element Name	Description	Special Type
BPE0028. Check Reference Number Uniqueness	Check whether message reference numbers are unique in the system.	Service Task
↳ Business Rule 1	<i>Check Message Identification uniqueness</i>	
↳ Business Rule 74	<i>Check Local Reference Number (LRN) uniqueness</i>	
↳ Business Rule 75	<i>Check Movement Reference Number (MRN)uniqueness</i>	
↳ Business Rule 79	<i>Check Manifest reference number uniqueness</i>	
BPE0029. Perform syntactic validation	Check messages against the XSDs.	Service Task
↳ Business Rule 47	<i>Syntactic validation</i>	
BPE0030. Perform Business Codelists validation	Check the message business codelists.	Service Task
↳ Business Rule 50	<i>Business codelist validation against CDEPS:RDS</i>	
BPE0031. Perform Rules & Conditions Validation	Check the rules and conditions of the respective message.	Service Task
BPE0032. Report Errors	Report the identified errors from the validation process. The process terminates.	Service Task
BPE0520. Check if in appropriate state	Check whether the process for the particular entity (e.g. declaration/ application/ document) is on the appropriate state to process the received message. This check shall be performed based on the pertinent State Model of the system.	Service Task
↳ Business Rule 421	<i>Supplementary Declaration validation at Export</i>	
↳ Business Rule 448	<i>Check appropriate state for Export Declaration Amendment</i>	

CARM Customs Declaration and Excise Documents Processing system (CDEPS)	REF: CDEPS_EXPORT_BPS
Business Process Specifications for EXPORT System	VER:410

- ↳ **Business Rule** 449 *Check appropriate state Declaration Goods Presentation*
- ↳ **Business Rule** 468 *Guarantee Amendment*
- ↳ **Business Rule** 492 *Exit control results received at Export*
- ↳ **Business Rule** 493 *Export Declaration request at Export*

2.14.5.2 Event(s)

The table below defines the 'Event(s)' of the 'BP0005. Validate' process.

Element Name	Description	Special Type
BPE0027. A message or event notification from GUI is received for validation	Message input in the validation process.	Start
BPE0035. Validation completed successfully	The validation is completed successfully with no errors reported. The process terminates.	End
BPE0036. Validation completed with errors	The validation completed with errors. The process terminates.	End

2.14.5.3 Gateway(s)

The table below defines the 'Gateway(s)' of the 'BP0005. Validate' process.

Element Name	Description	Special Type
BPE0033. Merge Invalid Flows	Merge into exclusive event based gateway the invalid flows from all validation tasks.	Merge

CARM Customs Declaration and Excise Documents Processing system (CDEPS)	REF: CDEPS_EXPORT_BPS
Business Process Specifications for EXPORT System	VER:410

2.15. Process Group: Processing Guarantee Queries

2.15.1.BP0609. Process Guarantee Query at Export

Business Process Description

The following table provides general information about the 'BP0609. Process Guarantee Query at Export' process. The Business Process Diagram and the description of various business process elements are specified in the following paragraphs.

Description	The business process presents the steps taken for a guarantee query to be executed by the Customs Officer at Export to the Guarantee Management system for guarantees maintained at that Office
Precondition(s)	The Customs Officer has logged into the system and possesses sufficient rights.
Trigger	Customs Officer requests to execute a query on guarantee
Postcondition(s)	- Validation errors - Guarantee Query Dispatched

Business Process Diagram

The Business Process Diagram of 'BP0609. Process Guarantee Query at Export' is shown below in BPMN notation. The definition of a process that might be used as sub-process by the 'BP0609. Process Guarantee Query at Export' can be found in this document. Finally, Annex A of CDEPS-BPS-EXPORT provides some explanatory information about the used notation.

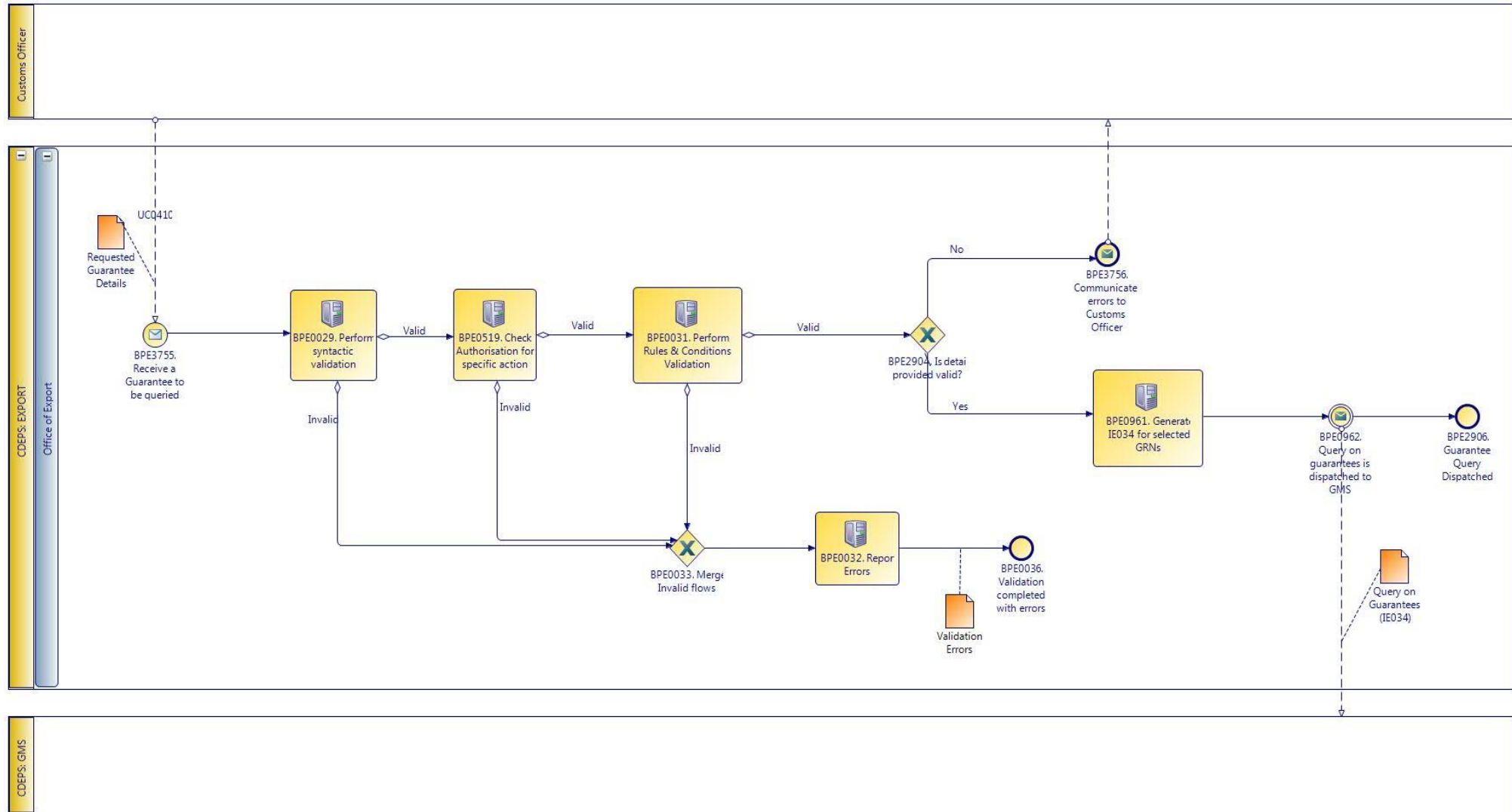

CARM Customs Declaration and Excise Documents Processing system (CDEPS)	REF: CDEPS_EXPORT_BPS
Business Process Specifications for EXPORT System	VER:410

2.15.1.1 Activities

The table below defines the 'Activities' of the 'BP0609. Process Guarantee Query at Export' process.

Element Name	Description	Special Type
BPE0029. Perform syntactic validation	Check messages against the XSDs.	Service Task
↳ Business Rule 47	<i>Syntactic validation</i>	
BPE0031. Perform Rules & Conditions Validation	Check the rules and conditions of the respective message.	Service Task
BPE0032. Report Errors	Report the identified errors from the validation process. The process terminates.	Service Task
BPE0961. Generate IE034 for selected GRNs	The Guarantee Query message is generated by the system per provided criteria by Officer Service Task	Service Task

2.15.1.2 Event(s)

The table below defines the 'Event(s)' of the 'BP0609. Process Guarantee Query at Export' process.

Element Name	Description	Special Type
BPE0036. Validation completed with errors	The validation completed with errors. The process terminates.	End
BPE0962. Query on guarantees is dispatched to GMS	Message (IE034) is dispatched to GMS	End
BPE2906. Guarantee Query Dispatched	Guarantee Query Dispatched	End
BPE3755. Receive a Guarantee to be queried	Receive a Guarantee to be queried	Start
BPE3756. Communicate errors to Customs Officer	Communicate errors to Customs Officer	End

CARM Customs Declaration and Excise Documents Processing system (CDEPS)	REF: CDEPS_EXPORT_BPS
Business Process Specifications for EXPORT System	VER:410

2.15.1.3 Gateway(s)

The table below defines the 'Gateway(s)' of the 'BP0609. Process Guarantee Query at Export' process.

Element Name	Description	Special Type
BPE0033. Merge Invalid Flows	Merge into exclusive event based gateway the invalid flows from all validation tasks.	Merge
BPE2904. Is detail provided valid?	Checks if the provided information from Customs Officer is valid	Decision
↳ Business Rule 217	<i>Guarantee Query Type 4</i>	
↳ Business Rule 219	<i>Check Dates</i>	

CARM Customs Declaration and Excise Documents Processing system (CDEPS)	REF: CDEPS_EXPORT_BPS
Business Process Specifications for EXPORT System	VER:410

2.15.2.BP0610. Handle Response on Guarantees Query at Export

Business Process Description

The following table provides general information about the 'BP0610. Handle Response on Guarantees Query at Export' process. The Business Process Diagram and the description of various business process elements are specified in the following paragraphs.

Description	The process describes the actions performed by the System in order to handle the response on guarantee query received by the Guarantee Management System
Precondition(s)	A Query on Guarantees must have previously been sent
Trigger	The reception of the Guarantee Query Response
Postcondition(s)	The information can be accessed

Business Process Diagram

The Business Process Diagram of 'BP0610. Handle Response on Guarantees Query at Export' is shown below in BPMN notation. The definition of a process that might be used as sub-process by the 'BP0610. Handle Response on Guarantees Query at Export' can be found in this document. Finally, Annex A of CDEPS-BPS-EXPORT provides some explanatory information about the used notation.

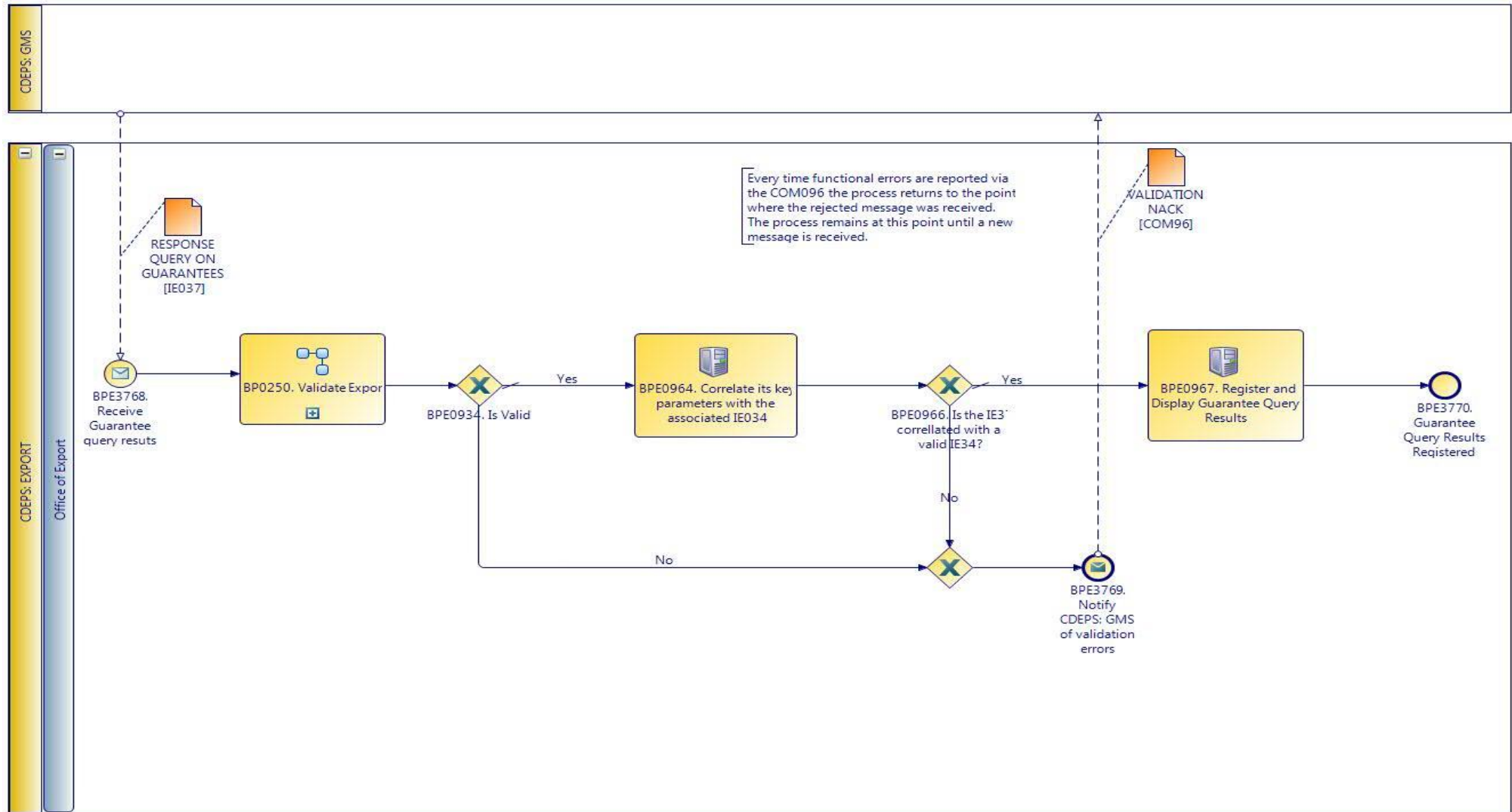

CARM Customs Declaration and Excise Documents Processing system (CDEPS)	REF: CDEPS_EXPORT_BPS
Business Process Specifications for EXPORT System	VER:410

2.15.2.1 Activities

The table below defines the 'Activities' of the 'BP0610. Handle Response on Guarantees Query at Export' process.

Element Name	Description	Special Type
BPE0964. Correlate its key parameters with the associated IE034	Correlate its key parameters with the associated IE034	Service Task
↳ Business Rule 220	<i>Correlation parameters</i>	
BPE0965. Reject IE037	Due to the problems found in the received IE037 the message is rejected by the system	Service Task
BPE0967. Register and Display Guarantee Query Results	The system registers and displays to the user the results of the guarantee query as received from CDEPS: GMS	Service Task

2.15.2.2 Event(s)

The table below defines the 'Event(s)' of the 'BP0610. Handle Response on Guarantees Query at Export' process.

Element Name	Description	Special Type
BPE0963. An IE037 is received		Start
BPE2907. Generate and sent IE906 to GMS	REjection messge IE906 is generated and sent	End
BPE2908. Query Response has been rejected with IE906	Query Response has been rejected with IE906	End
BPE2909. Guarantee Query Response Registered	Guarantee Query Response Registered	End

CARM Customs Declaration and Excise Documents Processing system (CDEPS)	REF: CDEPS_EXPORT_BPS
Business Process Specifications for EXPORT System	VER:410

2.15.2.3 Gateway(s)

The table below defines the 'Gateway(s)' of the 'BP0610. Handle Response on Guarantees Query at Export' process.

Element Name	Description	Special Type
BPE0934. Is Valid?	A decision point in the process to navigate the flow based on the message validation result.	Decision
↳ Business Rule 638	<i>Import declaration type 'X' cannot be cancelled</i>	
↳ Business Rule 646	<i>Guarantees during the registration of Import declaration type 'X'</i>	
↳ Business Rule 80	<i>Valid Message</i>	
BPE0966. Is the IE037 correlated with a valid IE034?	A decision point in the flow to navigate the process based on whether the IE037 message is correlate with the IE034 message	Decision

CARM Customs Declaration and Excise Documents Processing system (CDEPS)	REF: CDEPS_EXPORT_BPS
Business Process Specifications for EXPORT System	VER:410

2.15.3.BP0250. Validate Export

Business Process Description

The following table provides general information about the 'BP0250. Validate Export' process. The Business Process Diagram and the description of various business process elements are specified in the following paragraphs.

Description	Reusable subprocess that performs the message validation tasks for Export Regime.
Precondition(s)	None
Trigger	The process is triggered when an electronic message is received for validation.
Postcondition(s)	The validation is either completed successfully or with errors reported

Business Process Diagram

The Business Process Diagram of 'BP0250. Validate Export' is shown below in BPMN notation. The definition of a process that might be used as sub-process by the 'BP0250. Validate Export' can be found in this document. Finally, Annex A of CDEPS-BPS-EXPORT provides some explanatory information about the used notation.

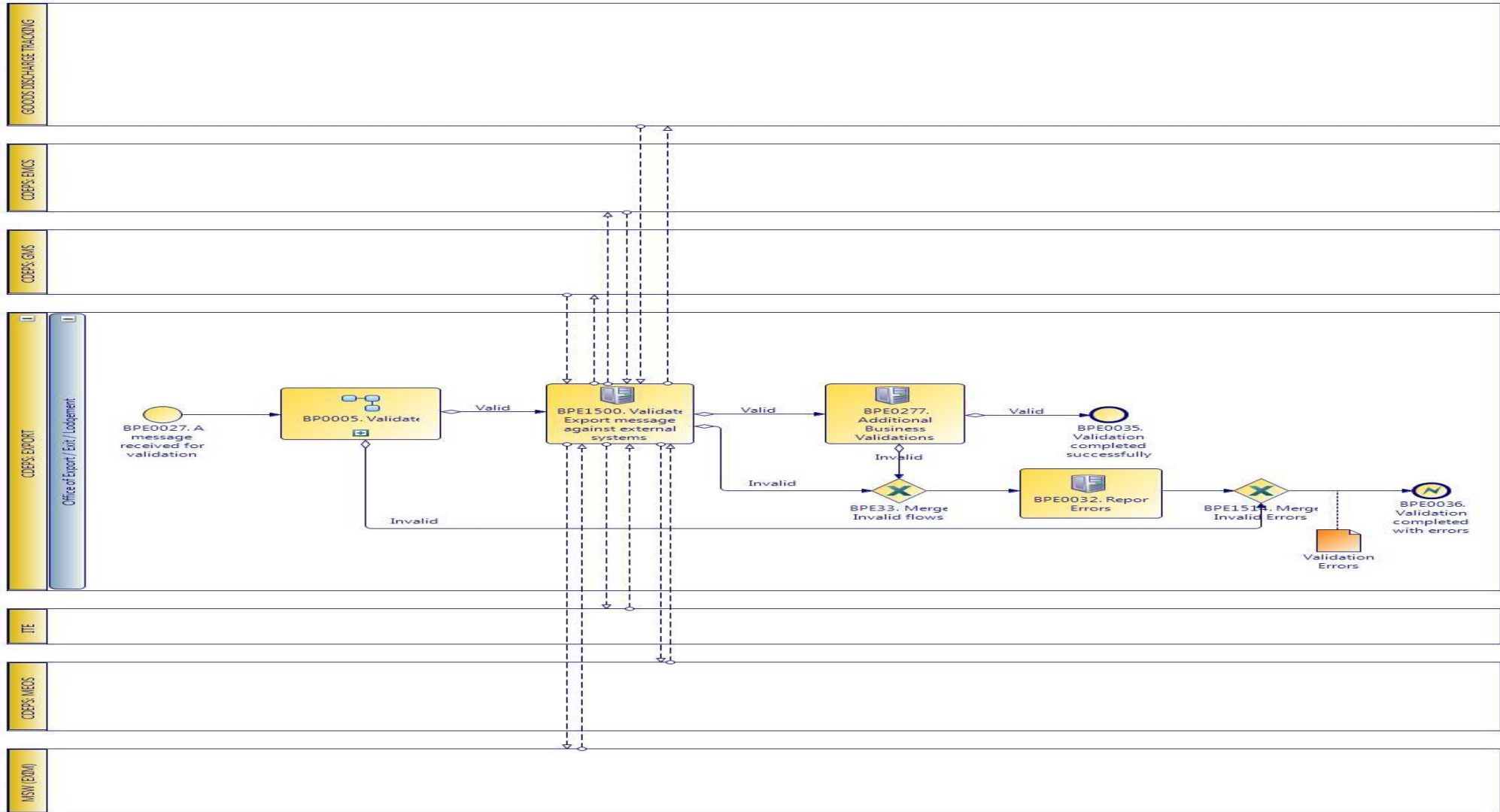

CARM Customs Declaration and Excise Documents Processing system (CDEPS)	REF: CDEPS_EXPORT_BPS
Business Process Specifications for EXPORT System	VER:410

2.15.3.1 Activities

The table below defines the 'Activities' of the 'BP0250. Validate Export' process.

Element Name	Description	Special Type
BPE0032. Report Errors	Report the identified errors from the validation process. The process terminates.	Service Task
BPE0277. Additional Business Validations for Export	The system performs any additional business validations specific to Export System.	Service Task
↳ Business Rule 19	Trader amending data same as Person lodging the declaration	
↳ Business Rule 21	Reject ENS/EXS amendment if ENS/EXS is not in appropriate state	
↳ Business Rule 245	Validate Personal ID	
↳ Business Rule 39	Cancellation Constraint	
↳ Business Rule 520	Import/ Export allowed guarantee types	
↳ Business Rule 70	EXS exists at the Office of Exit	
↳ Business Rule 71	Manifest number in IE547 and IE590	
BPE1500. Validate Export message against external systems	The system performs message validations against external systems.	Service Task
↳ Business Rule 101	Validate Economic Operator against MEOS	
↳ Business Rule 422	Validation of NCTS notifications	
↳ Business Rule 425	Goods Discharge required	
↳ Business Rule 439	Validate against GMS for integrity check	
↳ Business Rule 440	Validate Economic Operator's TIN against MEOS	
↳ Business Rule 494	Orchestrate validation of Export message against external systems	
↳ Business Rule 508	Validation of Export licenses with EXIM	

CARM Customs Declaration and Excise Documents Processing system (CDEPS)	REF: CDEPS_EXPORT_BPS
Business Process Specifications for EXPORT System	VER:410
↳ Business Rule 509	Check Export authorizations with MEOS
↳ Business Rule 51	Validate declared Combined Nomenclature in Declaration against ITE.
↳ Business Rule 510	Check Export authorizations for representation with MEOS
↳ Business Rule 511	Check Evidence of Power of Attorney with MEOS
↳ Business Rule 521	Validate Export declaration against ITE (duty calculation).
↳ Business Rule 522	Validate Export declaration data against Goods Discharge Tracking system
↳ Business Rule 527	Validate Export Declaration data against Excise system

2.15.3.2 Event(s)

The table below defines the 'Event(s)' of the 'BP0250. Validate Export' process.

Element Name	Description	Special Type
BPE0027. A message or event notification from GUI is received for validation	Message input in the validation process.	Start
BPE0035. Validation completed successfully	The validation is completed successfully with no errors reported. The process terminates.	End
BPE0036. Validation completed with errors	The validation completed with errors. The process terminates.	End

2.15.3.3 Gateway(s)

The table below defines the 'Gateway(s)' of the 'BP0250. Validate Export' process.

Element Name	Description	Special Type
BPE1514. Merge Invalid Errors	Combines exclusively either the negative outcome of generic validate process (BP0005. Validate) which reports errors or the errors from the extra checks for the specific system.	Merge

CARM Customs Declaration and Excise Documents Processing system (CDEPS)	REF: CDEPS_EXPORT_BPS
Business Process Specifications for EXPORT System	VER:410

2.15.4.BP0005. Validate

Business Process Description

The following table provides general information about the 'BP0005. Validate' process. The Business Process Diagram and the description of various business process elements are specified in the following paragraphs.

Description	Reusable subprocess that performs the message validation tasks
Precondition(s)	None
Trigger	The process is triggered when an electronic message is received for validation.
Postcondition(s)	

Business Process Diagram

The Business Process Diagram of 'BP0005. Validate' is shown below in BPMN notation. The definition of a process that might be used as sub-process by the 'BP0005. Validate' can be found in this document. Finally, Annex A of CDEPS-BPS-EXPORT provides some explanatory information about the used notation.

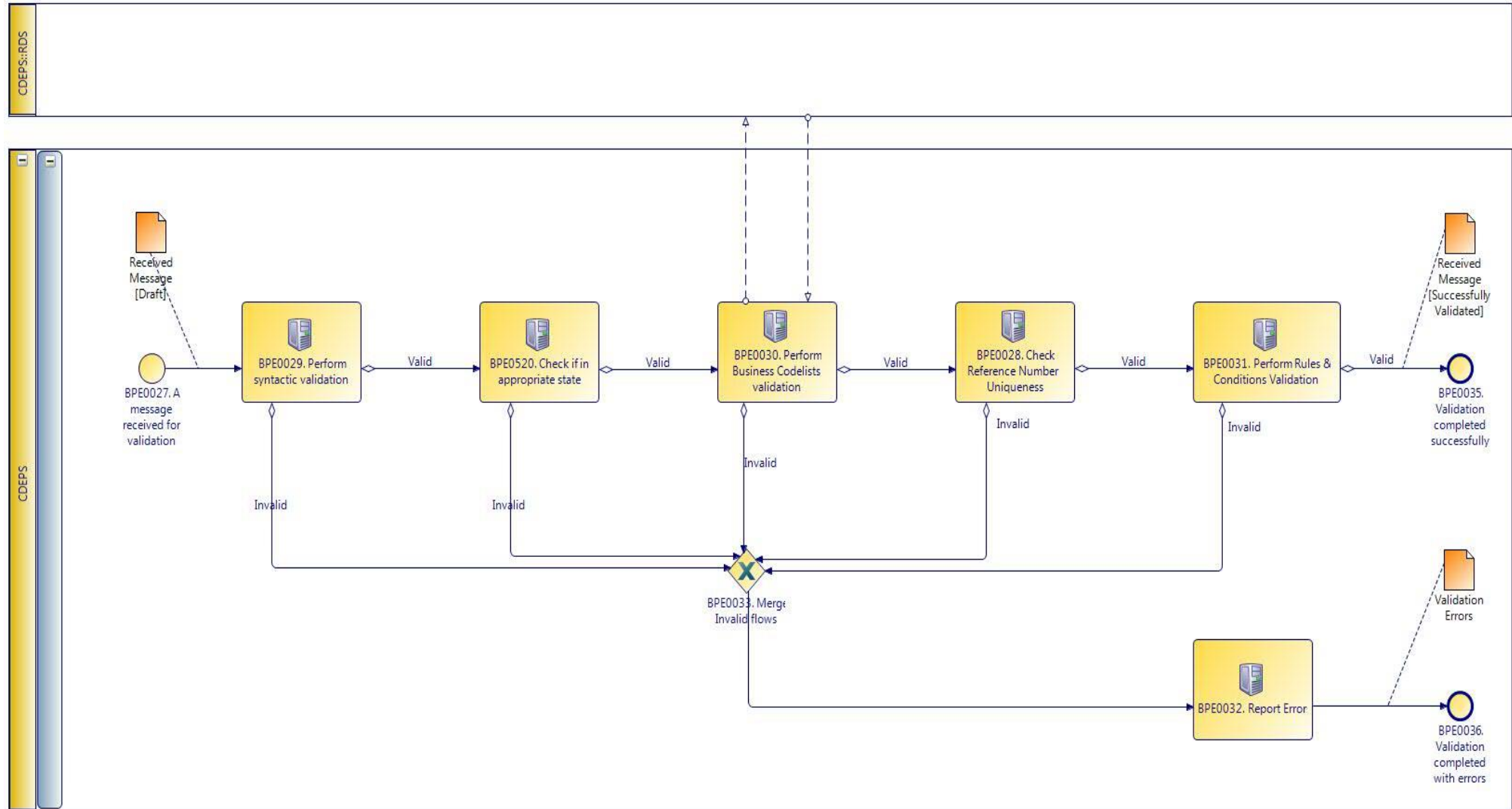

CARM Customs Declaration and Excise Documents Processing system (CDEPS)	REF: CDEPS_EXPORT_BPS
Business Process Specifications for EXPORT System	VER:410

2.15.4.1 Activities

The table below defines the 'Activities' of the 'BP0005. Validate' process.

Element Name	Description	Special Type
BPE0028. Check Reference Number Uniqueness	Check whether message reference numbers are unique in the system.	Service Task
↳ Business Rule 1	<i>Check Message Identification uniqueness</i>	
↳ Business Rule 74	<i>Check Local Reference Number (LRN) uniqueness</i>	
↳ Business Rule 75	<i>Check Movement Reference Number (MRN)uniqueness</i>	
↳ Business Rule 79	<i>Check Manifest reference number uniqueness</i>	
BPE0029. Perform syntactic validation	Check messages against the XSDs.	Service Task
↳ Business Rule 47	<i>Syntactic validation</i>	
BPE0030. Perform Business Codelists validation	Check the message business codelists.	Service Task
↳ Business Rule 50	<i>Business codelist validation against CDEPS:RDS</i>	
BPE0031. Perform Rules & Conditions Validation	Check the rules and conditions of the respective message.	Service Task
BPE0032. Report Errors	Report the identified errors from the validation process. The process terminates.	Service Task
BPE0520. Check if in appropriate state	Check whether the process for the particular entity (e.g. declaration/ application/ document) is on the appropriate state to process the received message. This check shall be performed based on the pertinent State Model of the system.	Service Task
↳ Business Rule 421	<i>Supplementary Declaration validation at Export</i>	
↳ Business Rule 448	<i>Check appropriate state for Export Declaration Amendment</i>	

CARM Customs Declaration and Excise Documents Processing system (CDEPS)	REF: CDEPS_EXPORT_BPS
Business Process Specifications for EXPORT System	VER:410

- ↳ **Business Rule** 449 *Check appropriate state Declaration Goods Presentation*
- ↳ **Business Rule** 468 *Guarantee Amendment*
- ↳ **Business Rule** 492 *Exit control results received at Export*
- ↳ **Business Rule** 493 *Export Declaration request at Export*

2.15.4.2 Event(s)

The table below defines the 'Event(s)' of the 'BP0005. Validate' process.

Element Name	Description	Special Type
BPE0027. A message or event notification from GUI is received for validation	Message input in the validation process.	Start
BPE0035. Validation completed successfully	The validation is completed successfully with no errors reported. The process terminates.	End
BPE0036. Validation completed with errors	The validation completed with errors. The process terminates.	End

2.15.4.3 Gateway(s)

The table below defines the 'Gateway(s)' of the 'BP0005. Validate' process.

Element Name	Description	Special Type
BPE0033. Merge Invalid Flows	Merge into exclusive event based gateway the invalid flows from all validation tasks.	Merge

CARM Customs Declaration and Excise Documents Processing system (CDEPS)	REF: CDEPS_EXPORT_BPS
Business Process Specifications for EXPORT System	VER:410

2.16. Process Group: Oral Export Declaration processing at Export

2.16.1.BP0576. Process Oral Export Declaration

Business Process Description

The following table provides general information about the 'BP0576. Process Oral Export Declaration' process. The Business Process Diagram and the description of various business process elements are specified in the following paragraphs.

Description	A master process that describes the tasks performed by the system in order to process the received Oral Export declaration till it is finalized
Precondition(s)	None
Trigger	The Customs Officer inserts the oral declaration data
Postcondition(s)	The declaration is 'Finalized'

Business Process Diagram

The Business Process Diagram of 'BP0576. Process Oral Export Declaration' is shown below in BPMN notation. The definition of a process that might be used as sub-process by the 'BP0576. Process Oral Export Declaration' can be found in this document. Finally, Annex A of CDEPS-BPS-EXPORT provides some explanatory information about the used notation.

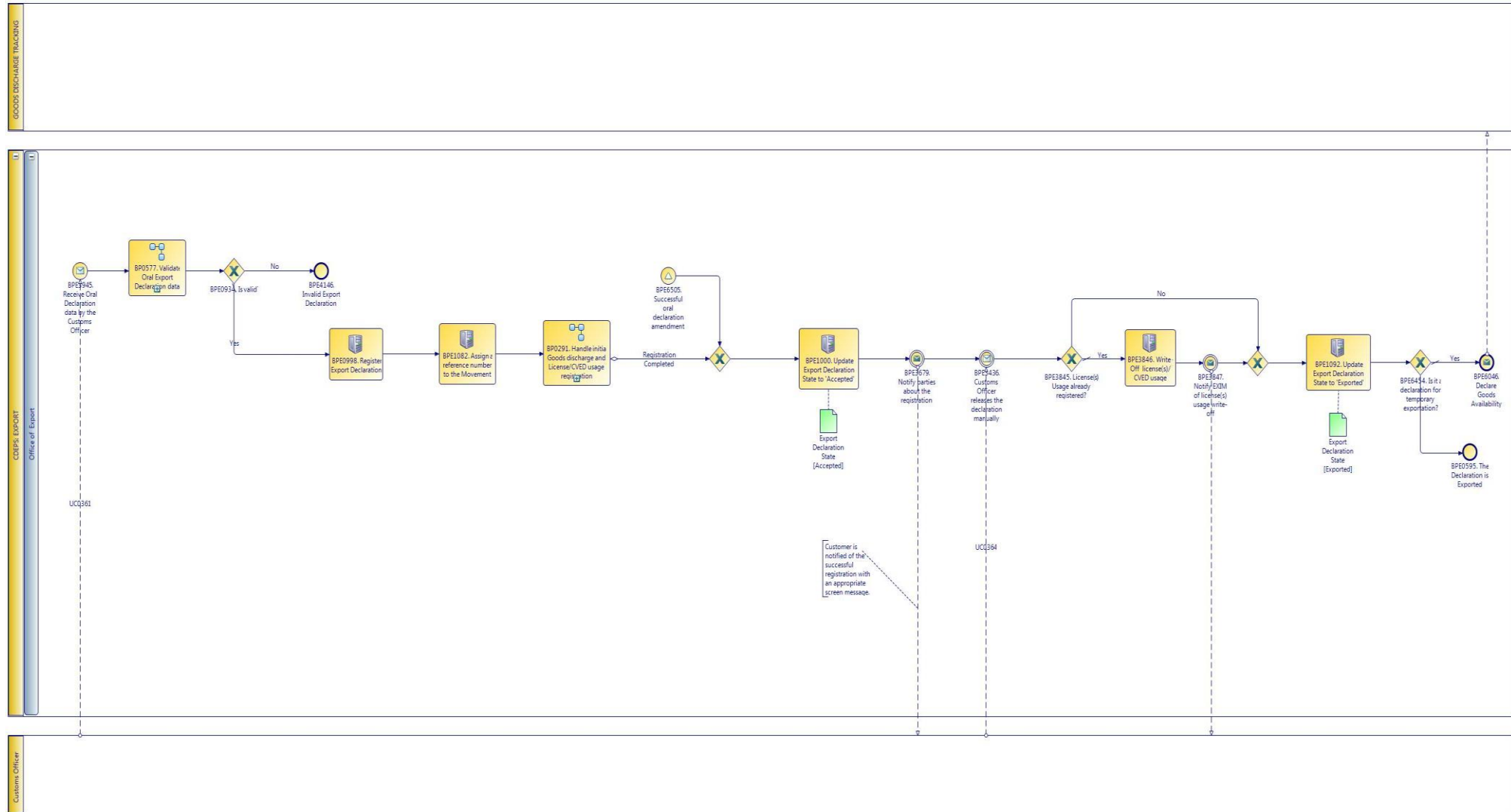

CARM Customs Declaration and Excise Documents Processing system (CDEPS)	REF: CDEPS_EXPORT_BPS
Business Process Specifications for EXPORT System	VER:410

2.16.1.1 Activities

The table below defines the 'Activities' of the 'BP0576. Process Oral Export Declaration' process.

Element Name	Description	Special Type
BPE0998. Register Export Declaration	The validated export declaration received from either the Trader or the Customs Officer is finally registered in the system	Service Task
BPE1000. Update Export Declaration State to 'Accepted'	The system updates the declaration state to 'Accepted'	Service Task
BPE1082. Assign a reference number to the Movement	The System assigns a reference number to the Movement	Service Task
↳ Business Rule 253	<i>Movement Reference Number (MRN) Structure</i>	
BPE1092. Update Export Declaration State to 'Exported'	The system updates the Export Declaration State to 'Exported'	Service Task
BPE3436. Customs Officer releases the declaration manually	The declaration is manually released by the Customs Officer	Receive Task
BPE3846. Write - Off license(s)/CVED usage	Write - Off license(s)/CVED usage	Service Task

2.16.1.2 Event(s)

The table below defines the 'Event(s)' of the 'BP0576. Process Oral Export Declaration' process.

Element Name	Description	Special Type
BPE0595. The Declaration is Exported	The Declaration is Exported and the process terminates	End
BPE3679. Notify parties about the registration	Upon the validation of the Declaration data the parties are notified of the successful registration	Intermediate

CARM Customs Declaration and Excise Documents Processing system (CDEPS)	REF: CDEPS_EXPORT_BPS
Business Process Specifications for EXPORT System	VER:410

BPE3847. Notify EXIM of license(s) usage write-off	Notify EXIM of license(s) usage write-off	Intermediate
BPE3945. Receive Oral Declaration data by the Customs Officer	The system receives the oral declaration data the Customs officer enters	Start
BPE4146. Invalid Export Declaration	The Export Declaration is invalidated and the process terminates	End
BPE6046. Declare Goods Availability	The current document declare its goods as available to be used by upcoming Movements.	End
↳ Business Rule	604 Goods availability to Discharge Module according previous procedure	
↳ Business Rule	605 Goods availability to Discharge Module according procedure	
↳ Business Rule	640 Import declaration type 'X' to discharge module	
BPE6505. Successful oral declaration amendment	Successful oral declaration amendment	Start

2.16.1.3 Gateway(s)

The table below defines the 'Gateway(s)' of the 'BP0576. Process Oral Export Declaration' process.

Element Name	Description	Special Type
BPE0934. Is Valid?	A decision point in the process to navigate the flow based on the message validation result.	Decision
↳ Business Rule	638 Import declaration type 'X' cannot be cancelled	
↳ Business Rule	646 Guarantees during the registration of Import declaration type 'X'	
↳ Business Rule	80 Valid Message	
BPE3845. License(s) Usage already registered?	A decision point in the process to navigate the flow based on whether the usage of the licesnces has been already registered or not	Decision

CARM Customs Declaration and Excise Documents Processing system (CDEPS)	REF: CDEPS_EXPORT_BPS
Business Process Specifications for EXPORT System	VER:410

BPE6454. Is it a declaration for temporary exportation?

A decision point in the process to navigate the flow based on whether it is a declaration for temporary exportation in order to declare goods discharge availability or not Decision

CARM Customs Declaration and Excise Documents Processing system (CDEPS)	REF: CDEPS_EXPORT_BPS
Business Process Specifications for EXPORT System	VER:410

2.16.2.BP0577. Validate Oral Export Declaration data

Business Process Description

The following table provides general information about the 'BP0577. Validate Oral Export Declaration data' process. The Business Process Diagram and the description of various business process elements are specified in the following paragraphs.

Description	Reusable subprocess that performs the Oral Export Declaration's data validation for Export Regime.
Precondition(s)	None
Trigger	The process is triggered when declaration data are received for validation.
Postcondition(s)	The validation is either completed successfully or with errors reported

Business Process Diagram

The Business Process Diagram of 'BP0577. Validate Oral Export Declaration data' is shown below in BPMN notation. The definition of a process that might be used as sub-process by the 'BP0577. Validate Oral Export Declaration data' can be found in this document. Finally, Annex A of 'CDEPS-BPS-EXPORT' provides some explanatory information about the used notation.

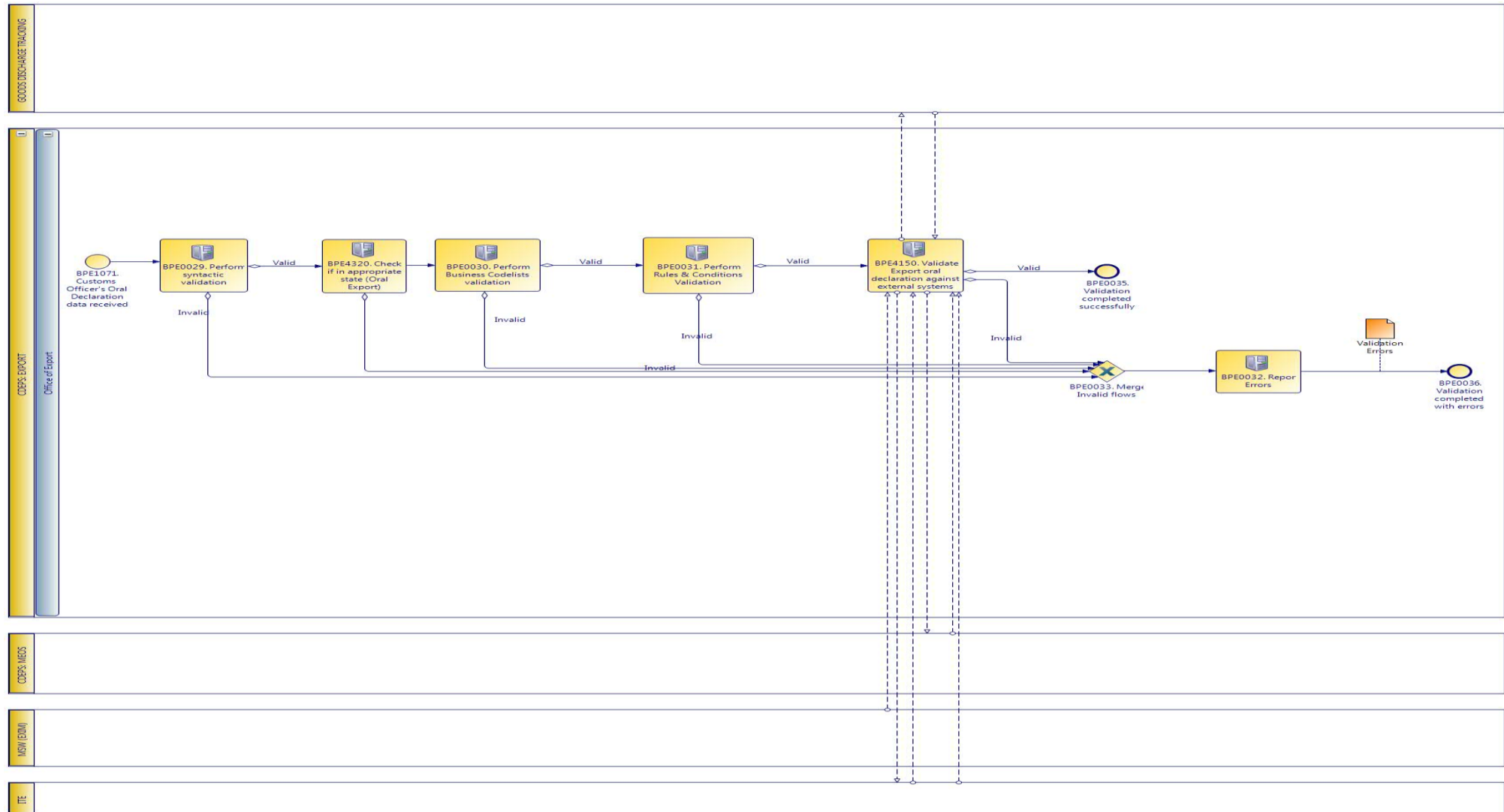

CARM Customs Declaration and Excise Documents Processing system (CDEPS)	REF: CDEPS_EXPORT_BPS
Business Process Specifications for EXPORT System	VER:410

2.16.2.1 Activities

The table below defines the 'Activities' of the 'BP0577. Validate Oral Export Declaration data' process.

Element Name	Description	Special Type
BPE0029. Perform syntactic validation	Check messages against the XSDs.	Service Task
↳ Business Rule 47	<i>Syntactic validation</i>	
BPE0030. Perform Business Codelists validation	Check the message business codelists.	Service Task
↳ Business Rule 50	<i>Business codelist validation against CDEPS:RDS</i>	
BPE0031. Perform Rules & Conditions Validation	Check the rules and conditions of the respective message.	Service Task
BPE0032. Report Errors	Report the identified errors from the validation process. The process terminates.	Service Task
BPE4150. Validate Export oral declaration against external systems	The system validates the Export oral declaration against external systems	Service Task
↳ Business Rule 101	<i>Validate Economic Operator against MEOS</i>	
↳ Business Rule 332	<i>Orchestrate validation of Oral Export Declaration against external systems</i>	
↳ Business Rule 425	<i>Goods Discharge required</i>	
↳ Business Rule 494	<i>Orchestrate validation of Export message against external systems</i>	
↳ Business Rule 508	<i>Validation of Export licenses with EXIM</i>	
↳ Business Rule 51	<i>Validate declared Combined Nomenclature in Declaration against ITE.</i>	
↳ Business Rule 522	<i>Validate Export declaration data against Goods Discharge Tracking system</i>	

CARM Customs Declaration and Excise Documents Processing system (CDEPS)	REF: CDEPS_EXPORT_BPS
Business Process Specifications for EXPORT System	VER:410

BPE4320. Check if in appropriate state (Oral Export)	Check if in appropriate state	Service Task
---	-------------------------------	--------------

↳ **Business Rule** 328 *Check appropriate state for Oral Export Declararion Amendment*

↳ **Business Rule** 329 *Check appropriate state for Oral Export Declararion Cancellation*

2.16.2.2 Event(s)

The table below defines the 'Event(s)' of the 'BP0577. Validate Oral Export Declaration data' process.

Element Name	Description	Special Type
BPE0035. Validation completed successfully	The validation is completed successfully with no errors reported. The process terminates.	End
BPE0036. Validation completed with errors	The validation completed with errors. The process terminates.	End
BPE1071. Customs Officer's Oral Declaration data received	Customs Officer's Oral Declaration data received	Start

2.16.2.3 Gateway(s)

The table below defines the 'Gateway(s)' of the 'BP0577. Validate Oral Export Declaration data' process.

Element Name	Description	Special Type
BPE0033. Merge Invalid Flows	Merge into exclusive event based gateway the invalid flows from all validation tasks.	Merge

CARM Customs Declaration and Excise Documents Processing system (CDEPS)	REF: CDEPS_EXPORT_BPS
Business Process Specifications for EXPORT System	VER:410

2.16.3.BP0291. Handle initial Goods discharge and License/CVED usage registration

Business Process Description

The following table provides general information about the 'BP0291. Handle initial Goods discharge and License/CVED usage registration' process. The Business Process Diagram and the description of various business process elements are specified in the following paragraphs.

Description	The process describes the action performed by the system in order to credit the previous documents declared in the submitted document
Precondition(s)	Previous Documents are included in the declaration
Trigger	A credit on previous documents is required
Postcondition(s)	None

Business Process Diagram

The Business Process Diagram of 'BP0291. Handle initial Goods discharge and License/CVED usage registration' is shown below in BPMN notation. The definition of a process that might be used as sub-process by the 'BP0291. Handle initial Goods discharge and License/CVED usage registration' can be found in this document. Finally, Annex A of CDEPS-BPS-EXPORT provides some explanatory information about the used notation.

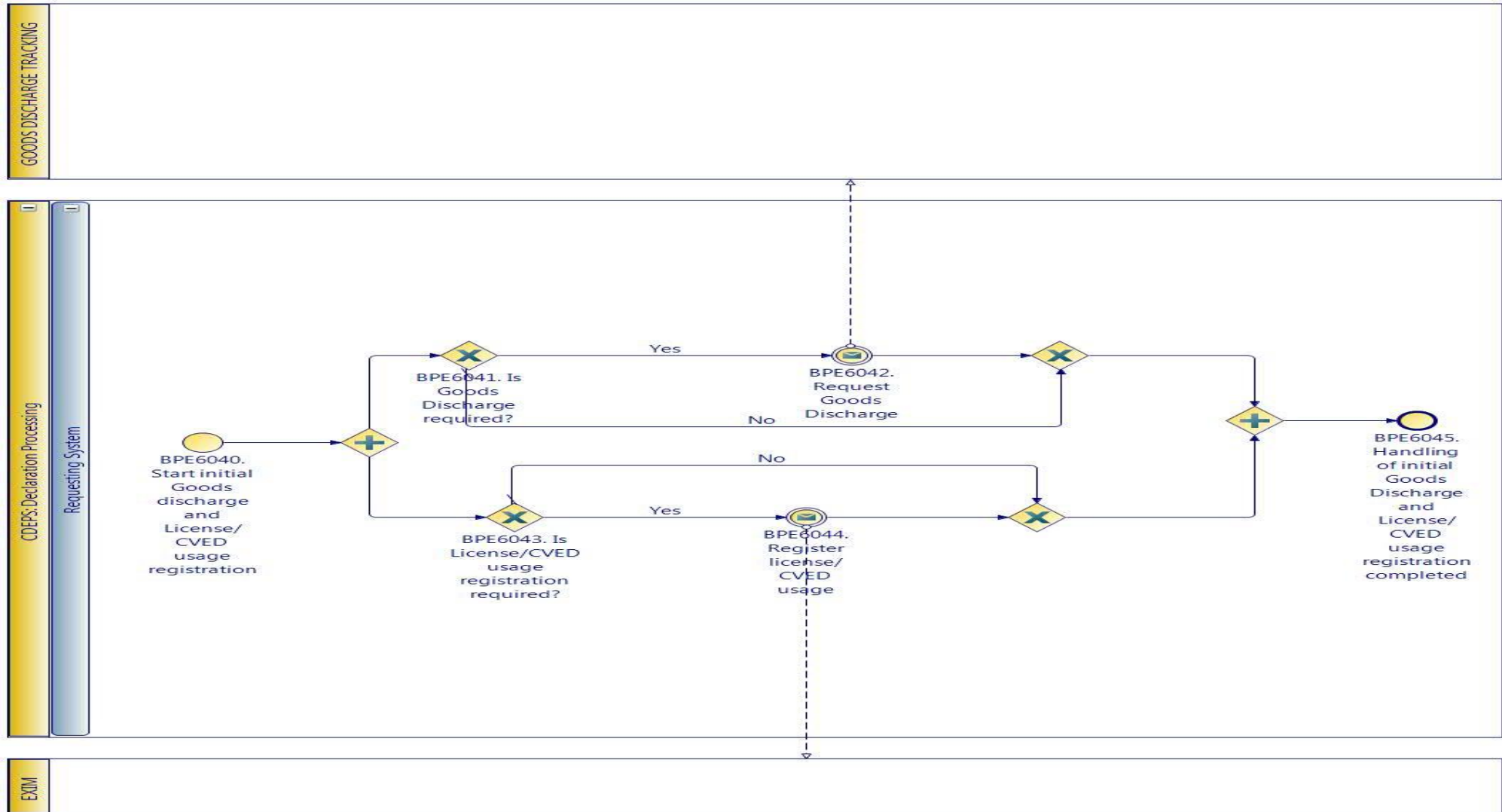

CARM Customs Declaration and Excise Documents Processing system (CDEPS)	REF: CDEPS_EXPORT_BPS
Business Process Specifications for EXPORT System	VER:410

2.16.3.1 Activities

The table below defines the 'Activities' of the 'BP0291. Handle initial Goods discharge and License/CVED usage registration' process.

Element Name	Description	Special Type
BPE3041. Report valid result	Report valid result	Service Task

2.16.3.2 Event(s)

The table below defines the 'Event(s)' of the 'BP0291. Handle initial Goods discharge and License/CVED usage registration' process.

Element Name	Description	Special Type
BPE6040. Start initial Goods discharge and License/CVED usage registration	This process is triggered by this start event for the registration of the declaration goods discharge and the license/CVED usage.	Start
BPE6042. Request Goods Discharge	The request for goods discharge is sent to the responsible for the goods discharge tracking system	Intermediate
BPE6044. Register license/CVED usage	The license/CVED usage is sent to EXIM to be registered	Intermediate
BPE6045. Handling of initial Goods Discharge and License/CVED usage registration completed	Handling of initial Goods Discharge and License/CVED usage registration completed	End

2.16.3.3 Gateway(s)

The table below defines the 'Gateway(s)' of the 'BP0291. Handle initial Goods discharge and License/CVED usage registration' process.

Element Name	Description	Special Type
BPE6041. Is Goods Discharge required?	A decision point in the process to navigate the flow based on whether a Goods Discharge Decision required?	
↳ Business Rule	425 Goods Discharge required	

↳ **Business Rule** 499 *Goods Discharge required (Export/Import Specific)*

BPE6043. Is License/CVED usage registration required? A decision point in the process to navigate the flow based on whether License/CVED usage registration required Decision

↳ **Business Rule** 424 *License/CVED usage registration required*

CARM Customs Declaration and Excise Documents Processing system (CDEPS)	REF: CDEPS_EXPORT_BPS
Business Process Specifications for EXPORT System	VER:410

2.17. Process Group: Oral Export operation Amendment at Export

2.17.1.BP0578. Process Oral Declaration Amendment at Export

Business Process Description

The following table provides general information about the 'BP0578. Process Oral Declaration Amendment at Export' process. The Business Process Diagram and the description of various business process elements are specified in the following paragraphs.

Description	A high level process describing the actions performed by the system in order to handle the amendment of an Oral Export Declaration at the Office of Export.
Precondition(s)	Accepted
Trigger	The process is triggered when a declaration amendment is requested at the Office of Export.
Postcondition(s)	- None - Accepted

Business Process Diagram

The Business Process Diagram of 'BP0578. Process Oral Declaration Amendment at Export' is shown below in BPMN notation. The definition of a process that might be used as sub-process by the 'BP0578. Process Oral Declaration Amendment at Export' can be found in this document. Finally, Annex A of CDEPS-BPS-EXPORT provides some explanatory information about the used notation.

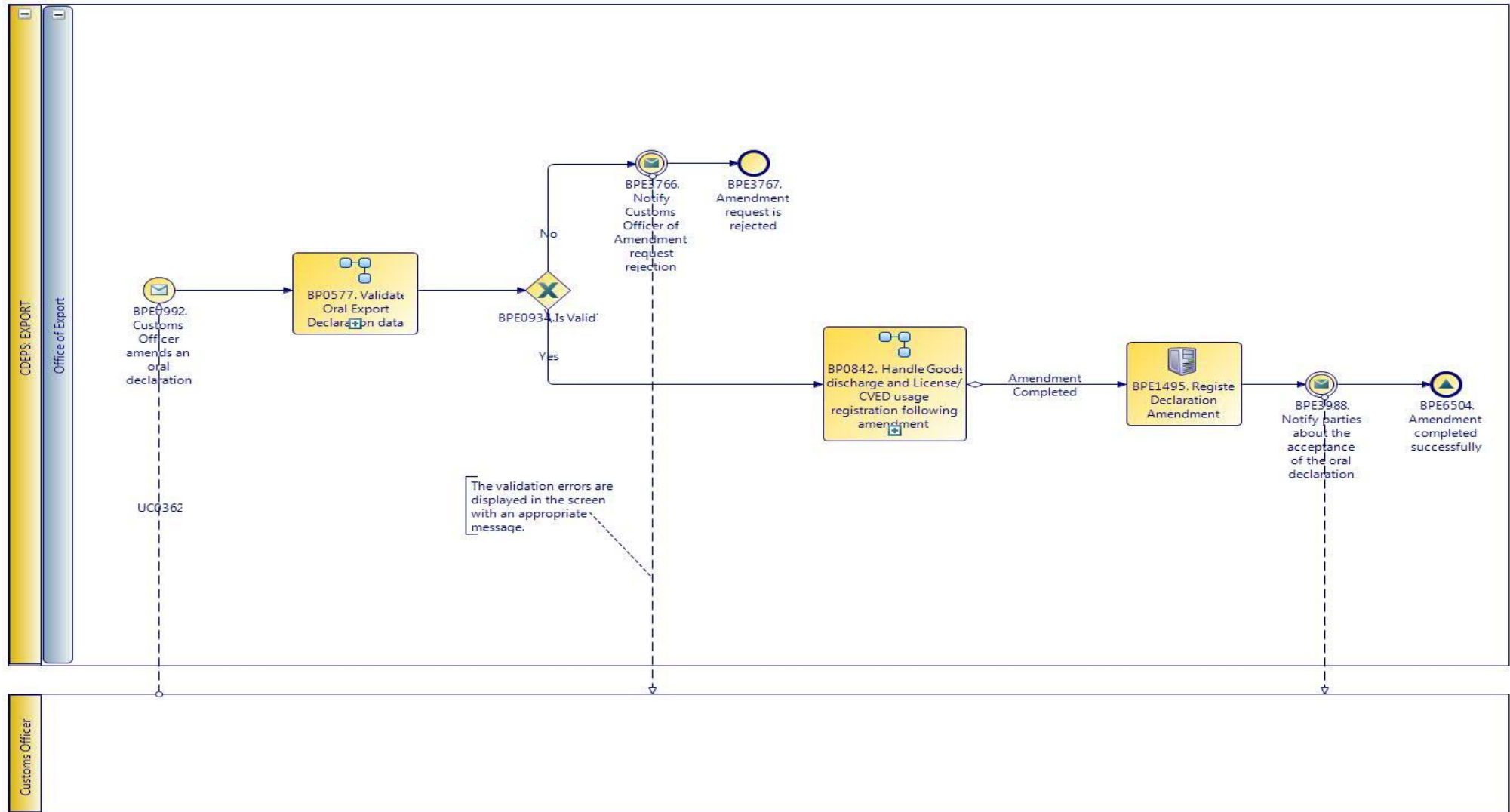

CARM Customs Declaration and Excise Documents Processing system (CDEPS)	REF: CDEPS_EXPORT_BPS
Business Process Specifications for EXPORT System	VER:410

2.17.1.1 Activities

The table below defines the 'Activities' of the 'BP0578. Process Oral Declaration Amendment at Export' process.

Element Name	Description	Special Type
BPE1495. Register Declaration Amendment	Upon its successful validation the declaration amendment request is registered in the system	Service Task

2.17.1.2 Event(s)

The table below defines the 'Event(s)' of the 'BP0578. Process Oral Declaration Amendment at Export' process.

Element Name	Description	Special Type
BPE0992. Customs Officer amends an oral declaration	The Customs Officer selects to amend an oral declaration	Start
BPE3766. Notify Customs Officer of Amendment request rejection	Notify Customs Officer of Amendment request rejection	Intermediate
BPE3767. Amendment request is rejected	Amendment request is rejected	End
BPE3988. Notify parties about the acceptance of the oral declaration	Upon the validation of the Oral Declaration amendment request the parties are notified of the successful registration	Intermediate
BPE6504. Amendment completed successfully	Amendment completed successfully	End

CARM Customs Declaration and Excise Documents Processing system (CDEPS)	REF: CDEPS_EXPORT_BPS
Business Process Specifications for EXPORT System	VER:410

2.17.1.3 Gateway(s)

The table below defines the 'Gateway(s)' of the 'BP0578. Process Oral Declaration Amendment at Export' process.

Element Name	Description	Special Type
BPE0934. Is Valid?	A decision point in the process to navigate the flow based on the message validation result.	Decision
↳ Business Rule 638	<i>Import declaration type 'X' cannot be cancelled</i>	
↳ Business Rule 646	<i>Guarantees during the registration of Import declaration type 'X'</i>	
↳ Business Rule 80	<i>Valid Message</i>	

CARM Customs Declaration and Excise Documents Processing system (CDEPS)	REF: CDEPS_EXPORT_BPS
Business Process Specifications for EXPORT System	VER:410

2.17.2.BP0577. Validate Oral Export Declaration data

Business Process Description

The following table provides general information about the 'BP0577. Validate Oral Export Declaration data' process. The Business Process Diagram and the description of various business process elements are specified in the following paragraphs.

Description	Reusable subprocess that performs the Oral Export Declaration's data validation for Export Regime.
Precondition(s)	None
Trigger	The process is triggered when declaration data are received for validation.
Postcondition(s)	The validation is either completed successfully or with errors reported

Business Process Diagram

The Business Process Diagram of 'BP0577. Validate Oral Export Declaration data' is shown below in BPMN notation. The definition of a process that might be used as sub-process by the 'BP0577. Validate Oral Export Declaration data' can be found in this document. Finally, Annex A of 'CDEPS-BPS-EXPORT' provides some explanatory information about the used notation.

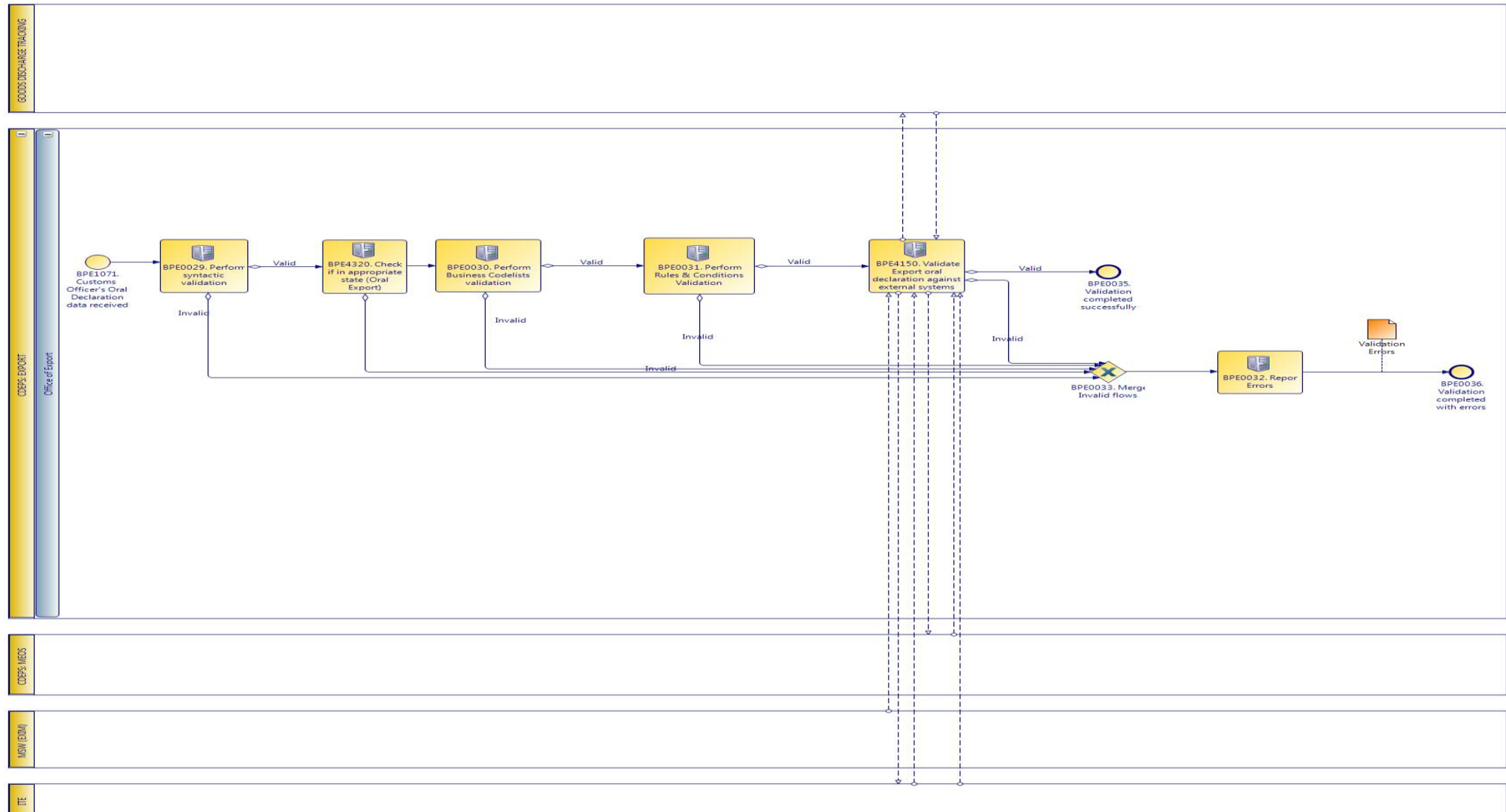

CARM Customs Declaration and Excise Documents Processing system (CDEPS)	REF: CDEPS_EXPORT_BPS
Business Process Specifications for EXPORT System	VER:410

2.17.2.1 Activities

The table below defines the 'Activities' of the 'BP0577. Validate Oral Export Declaration data' process.

Element Name	Description	Special Type
BPE0029. Perform syntactic validation	Check messages against the XSDs.	Service Task
↳ Business Rule 47	<i>Syntactic validation</i>	
BPE0030. Perform Business Codelists validation	Check the message business codelists.	Service Task
↳ Business Rule 50	<i>Business codelist validation against CDEPS:RDS</i>	
BPE0031. Perform Rules & Conditions Validation	Check the rules and conditions of the respective message.	Service Task
BPE0032. Report Errors	Report the identified errors from the validation process. The process terminates.	Service Task
BPE4150. Validate Export oral declaration against external systems	The system validates the Export oral declaration against external systems	Service Task
↳ Business Rule 101	<i>Validate Economic Operator against MEOS</i>	
↳ Business Rule 332	<i>Orchestrate validation of Oral Export Declaration against external systems</i>	
↳ Business Rule 425	<i>Goods Discharge required</i>	
↳ Business Rule 494	<i>Orchestrate validation of Export message against external systems</i>	
↳ Business Rule 508	<i>Validation of Export licenses with EXIM</i>	
↳ Business Rule 51	<i>Validate declared Combined Nomenclature in Declaration against ITE.</i>	
↳ Business Rule 522	<i>Validate Export declaration data against Goods Discharge Tracking system</i>	

CARM Customs Declaration and Excise Documents Processing system (CDEPS)	REF: CDEPS_EXPORT_BPS
Business Process Specifications for EXPORT System	VER:410

BPE4320. Check if in appropriate state (Oral Export)	Check if in appropriate state	Service Task
---	-------------------------------	--------------

↳ Business Rule	328	Check appropriate state for Oral Export Declararion Amendment
↳ Business Rule	329	Check appropriate state for Oral Export Declararion Cancellation

2.17.2.2 Event(s)

The table below defines the 'Event(s)' of the 'BP0577. Validate Oral Export Declaration data' process.

Element Name	Description	Special Type
BPE0035. Validation completed successfully	The validation is completed successfully with no errors reported. The process terminates.	End
BPE0036. Validation completed with errors	The validation completed with errors. The process terminates.	End
BPE1071. Customs Officer's Oral Declaration data received	Customs Officer's Oral Declaration data received	Start

2.17.2.3 Gateway(s)

The table below defines the 'Gateway(s)' of the 'BP0577. Validate Oral Export Declaration data' process.

Element Name	Description	Special Type
BPE0033. Merge Invalid Flows	Merge into exclusive event based gateway the invalid flows from all validation tasks.	Merge

CARM Customs Declaration and Excise Documents Processing system (CDEPS)	REF: CDEPS_EXPORT_BPS
Business Process Specifications for EXPORT System	VER:410

2.17.3.BP0842. Handle Goods discharge and License/CVED usage registration following amendment

Business Process Description

The following table provides general information about the 'BP0842. Handle Goods discharge and License/CVED usage registration following amendment' process. The Business Process Diagram and the description of various business process elements are specified in the following paragraphs.

Description	The process handles the amendment of an already registered goods discharge and the cancellation of an registered License/CVED usage.
Precondition(s)	The declaration is already accepted and the Goods discharge and/or license usage has been registered
Trigger	Manual amendment from the Customs Officer or electronically by the Trader
Postcondition(s)	The Goods discharge and/or license usage is re-registered

Business Process Diagram

The Business Process Diagram of 'BP0842. Handle Goods discharge and License/CVED usage registration following amendment' is shown below in BPMN notation. The definition of a process that might be used as sub-process by the 'BP0842. Handle Goods discharge and License/CVED usage registration following amendment' can be found in this document. Finally, Annex A of CDEPS-BPS-EXPORT provides some explanatory information about the used notation.

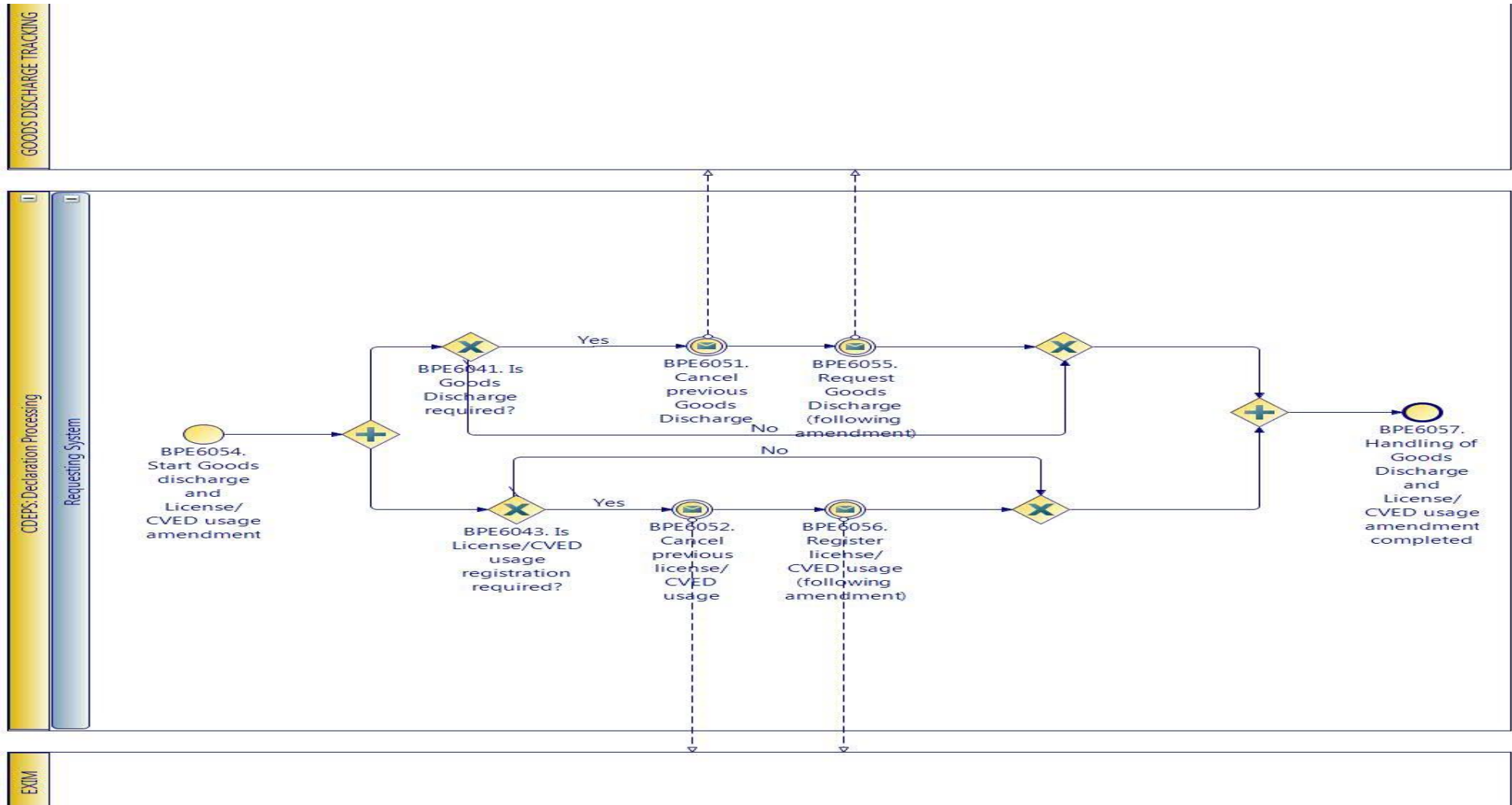

CARM Customs Declaration and Excise Documents Processing system (CDEPS)	REF: CDEPS_EXPORT_BPS
Business Process Specifications for EXPORT System	VER:410

2.17.3.1 Event(s)

The table below defines the 'Event(s)' of the 'BP0842. Handle Goods discharge and License/CVED usage registration following amendment' process.

Element Name	Description	Special Type
BPE6051. Cancel previous Goods	The system sends to the goods discharge tracking system a cancellation request for an already registered goods discharge	Intermediate
BPE6052. Cancel previous license/CVED usage	The system sends to EXIM a cancellation request for an already registered licenses	Intermediate
BPE6054. Start Goods discharge and License/CVED usage amendment	The process starts when amendment of the goods discharge and license usage is required due to declaration amendment	Start
BPE6055. Request Goods Discharge (following amendment)	Request Goods Discharge (following amendment)	Intermediate
BPE6056. Register license/CVED usage (following amendment)	Register license/CVED usage (following amendment)	Intermediate
BPE6057. Handling of Goods Discharge and License/CVED usage amendment completed	Handling of Goods Discharge and License/CVED usage amendment completed	End

2.17.3.2 Gateway(s)

The table below defines the 'Gateway(s)' of the 'BP0842. Handle Goods discharge and License/CVED usage registration following amendment' process.

Element Name	Description	Special Type
BPE6041. Is Goods Discharge required?	A decision point in the process to navigate the flow based on whether a Goods Discharge Decision required?	
↳ Business Rule	425 <i>Goods Discharge required</i>	

↳ **Business Rule** 499 *Goods Discharge required (Export/Import Specific)*

BPE6043. Is License/CVED usage registration required? A decision point in the process to navigate the flow based on whether License/CVED usage registration required Decision

↳ **Business Rule** 424 *License/CVED usage registration required*

CARM Customs Declaration and Excise Documents Processing system (CDEPS)	REF: CDEPS_EXPORT_BPS
Business Process Specifications for EXPORT System	VER:410

2.18. Process Group: Oral Export operation Cancellation at Export

2.18.1.BP0579. Process Oral Declaration Cancellation at Export

Business Process Description

The following table provides general information about the 'BP0579. Process Oral Declaration Cancellation at Export' process. The Business Process Diagram and the description of various business process elements are specified in the following paragraphs.

Description	A high level process describing the actions performed by the system in order to handle the Oral Export Declaration Cancellation at the Office of Export.
Precondition(s)	- Accepted
Trigger	The process is triggered when a cancellation is requested at the Office of Export.
Postcondition(s)	- None - Cancelled

Business Process Diagram

The Business Process Diagram of 'BP0579. Process Oral Declaration Cancellation at Export' is shown below in BPMN notation. The definition of a process that might be used as sub-process by the 'BP0579. Process Oral Declaration Cancellation at Export' can be found in this document. Finally, Annex A of CDEPS-BPS-EXPORT provides some explanatory information about the used notation.

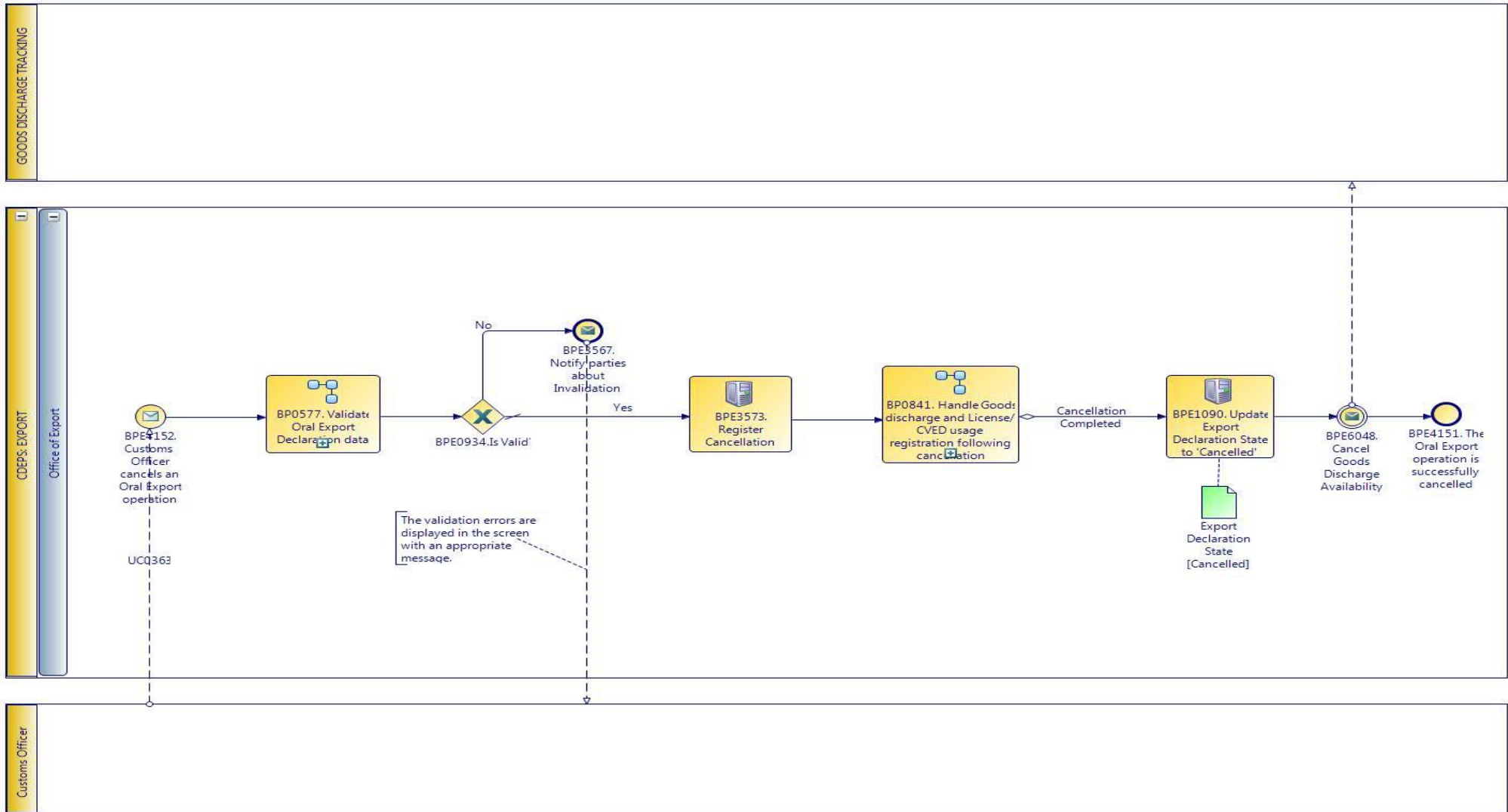

CARM Customs Declaration and Excise Documents Processing system (CDEPS)	REF: CDEPS_EXPORT_BPS
Business Process Specifications for EXPORT System	VER:410

2.18.1.1 Activities

The table below defines the 'Activities' of the 'BP0579. Process Oral Declaration Cancellation at Export' process.

Element Name	Description	Special Type
BPE1090. Update Export Declaration State to 'Cancelled'	The system updated the Export Declaration State to 'Cancelled'	Service Task
BPE3573. Register Cancellation	The system registers the cancellation	Service Task

2.18.1.2 Event(s)

The table below defines the 'Event(s)' of the 'BP0579. Process Oral Declaration Cancellation at Export' process.

Element Name	Description	Special Type
BPE3567. Notify parties about Invalidation	The parties are notified about the Invalidation of the cancellation request	End
BPE4151. The Oral Export operation is successfully cancelled	The Oral Export operation is successfully cancelled	End
BPE4152. Customs Officer cancels an Oral Export operation	The Customs Officer selects to cancel an already registered Oral Export operation.	Start
BPE6048. Cancel Goods Discharge Availability	The system makes its previous available for future use goods unavailable	Intermediate

↳ **Business Rule** 423 *Cancellation of goods availability*

CARM Customs Declaration and Excise Documents Processing system (CDEPS)	REF: CDEPS_EXPORT_BPS
Business Process Specifications for EXPORT System	VER:410

2.18.1.3 Gateway(s)

The table below defines the 'Gateway(s)' of the 'BP0579. Process Oral Declaration Cancellation at Export' process.

Element Name	Description	Special Type
BPE0934. Is Valid?	A decision point in the process to navigate the flow based on the message validation result.	Decision
↳ Business Rule 638	<i>Import declaration type 'X' cannot be cancelled</i>	
↳ Business Rule 646	<i>Guarantees during the registration of Import declaration type 'X'</i>	
↳ Business Rule 80	<i>Valid Message</i>	

CARM Customs Declaration and Excise Documents Processing system (CDEPS)	REF: CDEPS_EXPORT_BPS
Business Process Specifications for EXPORT System	VER:410

2.18.2.BP0577. Validate Oral Export Declaration data

Business Process Description

The following table provides general information about the 'BP0577. Validate Oral Export Declaration data' process. The Business Process Diagram and the description of various business process elements are specified in the following paragraphs.

Description	Reusable subprocess that performs the Oral Export Declaration's data validation for Export Regime.
Precondition(s)	None
Trigger	The process is triggered when declaration data are received for validation.
Postcondition(s)	The validation is either completed successfully or with errors reported

Business Process Diagram

The Business Process Diagram of 'BP0577. Validate Oral Export Declaration data' is shown below in BPMN notation. The definition of a process that might be used as sub-process by the 'BP0577. Validate Oral Export Declaration data' can be found in this document. Finally, Annex A of 'CDEPS-BPS-EXPORT' provides some explanatory information about the used notation.

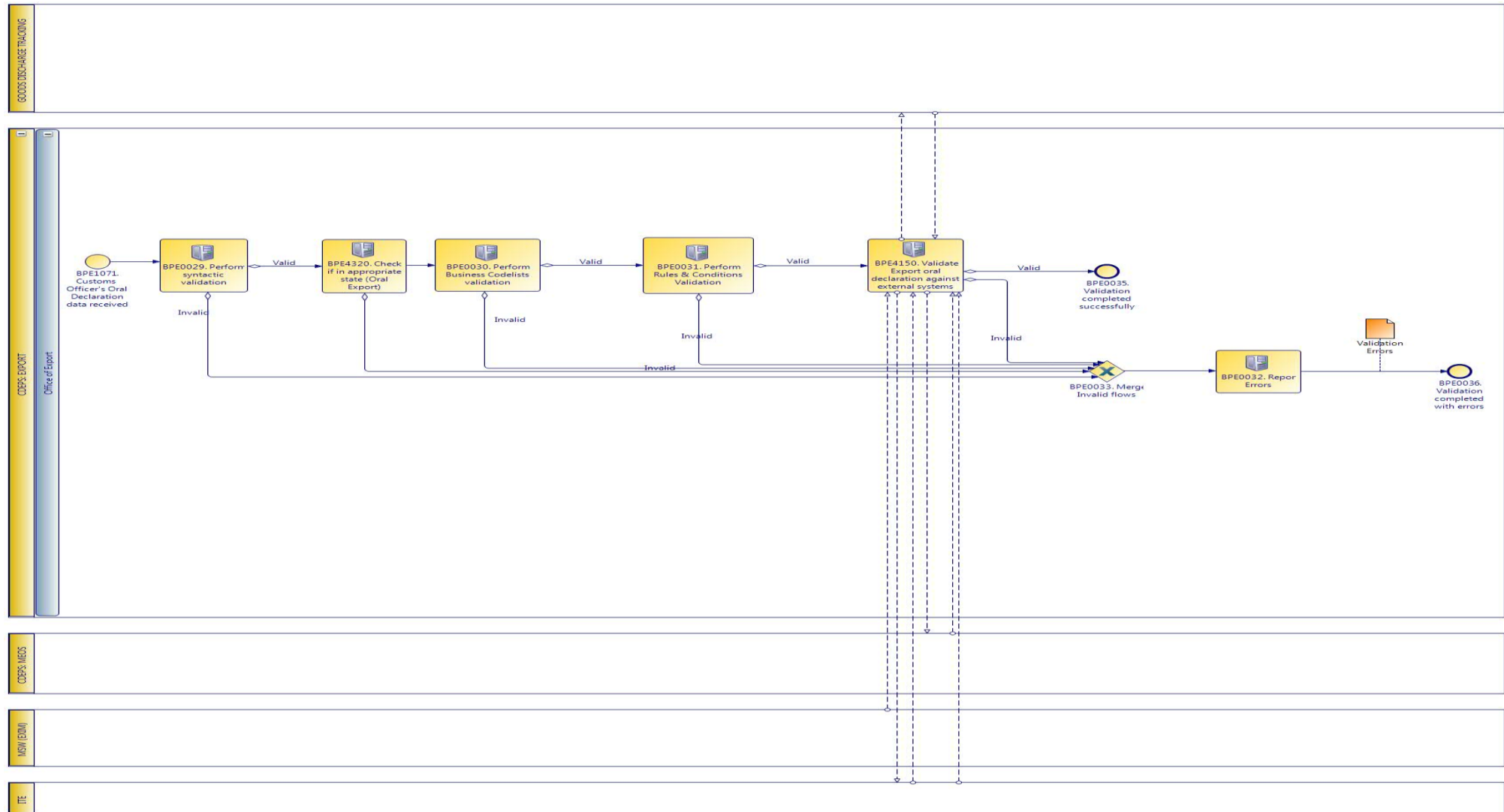

CARM Customs Declaration and Excise Documents Processing system (CDEPS)	REF: CDEPS_EXPORT_BPS
Business Process Specifications for EXPORT System	VER:410

2.18.2.1 Activities

The table below defines the 'Activities' of the 'BP0577. Validate Oral Export Declaration data' process.

Element Name	Description	Special Type
BPE0029. Perform syntactic validation	Check messages against the XSDs.	Service Task
↳ Business Rule 47	<i>Syntactic validation</i>	
BPE0030. Perform Business Codelists validation	Check the message business codelists.	Service Task
↳ Business Rule 50	<i>Business codelist validation against CDEPS:RDS</i>	
BPE0031. Perform Rules & Conditions Validation	Check the rules and conditions of the respective message.	Service Task
BPE0032. Report Errors	Report the identified errors from the validation process. The process terminates.	Service Task
BPE4150. Validate Export oral declaration against external systems	The system validates the Export oral declaration against external systems	Service Task
↳ Business Rule 101	<i>Validate Economic Operator against MEOS</i>	
↳ Business Rule 332	<i>Orchestrate validation of Oral Export Declaration against external systems</i>	
↳ Business Rule 425	<i>Goods Discharge required</i>	
↳ Business Rule 494	<i>Orchestrate validation of Export message against external systems</i>	
↳ Business Rule 508	<i>Validation of Export licenses with EXIM</i>	
↳ Business Rule 51	<i>Validate declared Combined Nomenclature in Declaration against ITE.</i>	
↳ Business Rule 522	<i>Validate Export declaration data against Goods Discharge Tracking system</i>	

CARM Customs Declaration and Excise Documents Processing system (CDEPS)	REF: CDEPS_EXPORT_BPS
Business Process Specifications for EXPORT System	VER:410

BPE4320. Check if in appropriate state (Oral Export)	Check if in appropriate state	Service Task
---	-------------------------------	--------------

↳ Business Rule	328	Check appropriate state for Oral Export Declararion Amendment
↳ Business Rule	329	Check appropriate state for Oral Export Declararion Cancellation

2.18.2.2 Event(s)

The table below defines the 'Event(s)' of the 'BP0577. Validate Oral Export Declaration data' process.

Element Name	Description	Special Type
BPE0035. Validation completed successfully	The validation is completed successfully with no errors reported. The process terminates.	End
BPE0036. Validation completed with errors	The validation completed with errors. The process terminates.	End
BPE1071. Customs Officer's Oral Declaration data received	Customs Officer's Oral Declaration data received	Start

2.18.2.3 Gateway(s)

The table below defines the 'Gateway(s)' of the 'BP0577. Validate Oral Export Declaration data' process.

Element Name	Description	Special Type
BPE0033. Merge Invalid Flows	Merge into exclusive event based gateway the invalid flows from all validation tasks.	Merge

CARM Customs Declaration and Excise Documents Processing system (CDEPS)	REF: CDEPS_EXPORT_BPS
Business Process Specifications for EXPORT System	VER:410

2.18.3.BP0841. Handle Goods discharge and License/CVED usage registration following cancellation

Business Process Description

The following table provides general information about the 'BP0841. Handle Goods discharge and License/CVED usage registration following cancellation' process. The Business Process Diagram and the description of various business process elements are specified in the following paragraphs.

Description	The process handles the cancellation of an already registered goods discharge and the cancellation of an already registered License/CVED usage.
Precondition(s)	The declaration is already accepted and the Goods discharge and/or license usage has been registered
Trigger	Manual cancellation from the Customs Officer or electronically by the Trader
Postcondition(s)	The Goods discharge and/or license usage is cancelled

Business Process Diagram

The Business Process Diagram of 'BP0841. Handle Goods discharge and License/CVED usage registration following cancellation' is shown below in BPMN notation. The definition of a process that might be used as sub-process by the 'BP0841. Handle Goods discharge and License/CVED usage registration following cancellation' can be found in this document. Finally, Annex A of CDEPS-BPS-EXPORT provides some explanatory information about the used notation.

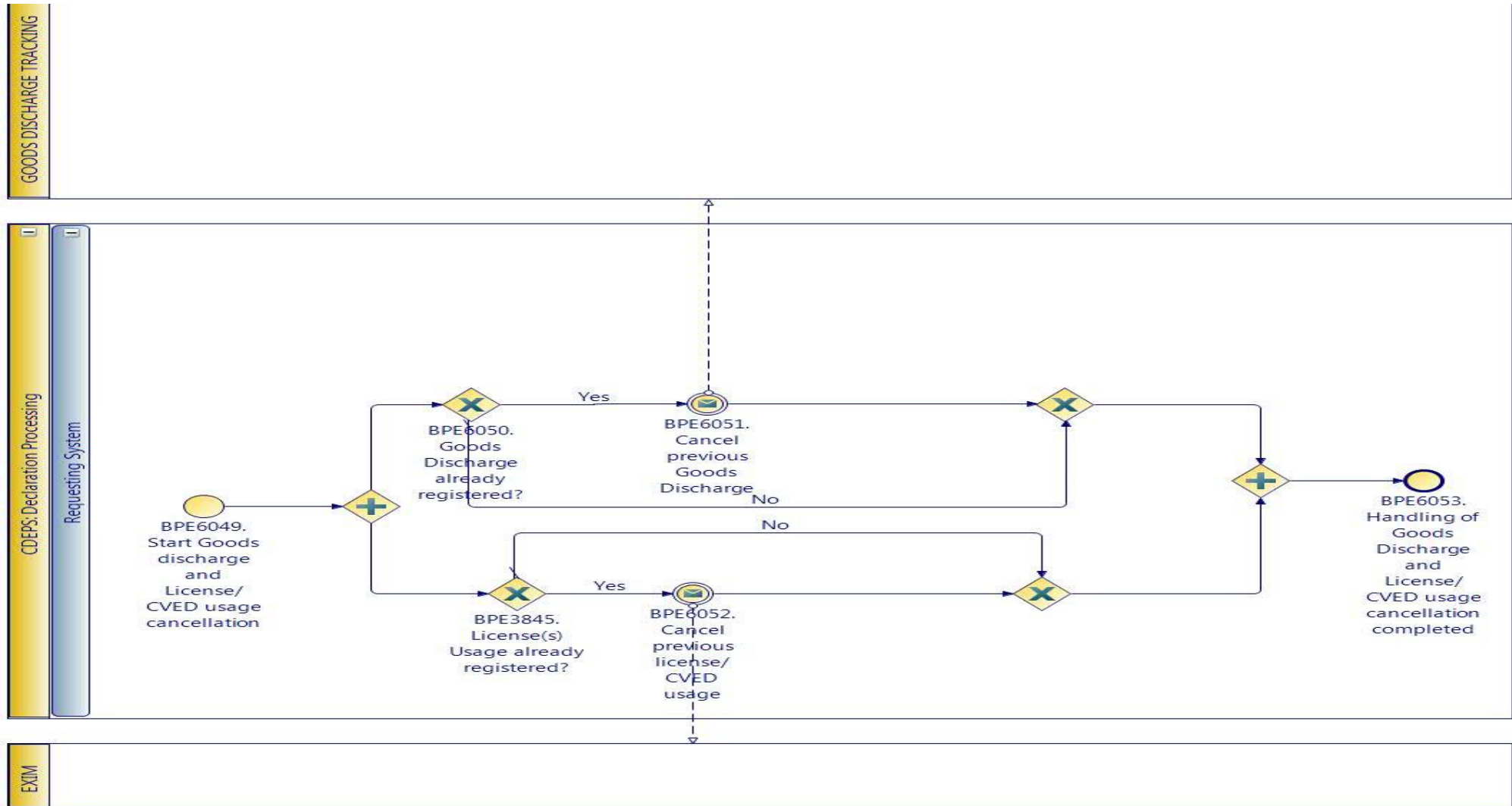

CARM Customs Declaration and Excise Documents Processing system (CDEPS)	REF: CDEPS_EXPORT_BPS
Business Process Specifications for EXPORT System	VER:410

2.18.3.1 Event(s)

The table below defines the 'Event(s)' of the 'BP0841. Handle Goods discharge and License/CVED usage registration following cancellation' process.

Element Name	Description	Special Type
BPE6049. Start Goods discharge and License/CVED usage cancellation	The process starts when the cancellation of the Goods discharge and License/CVED usage is required	Start
BPE6051. Cancel previous Goods	The system sends to the goods discharge tracking system a cancellation request for an already registered goods discharge	Intermediate
BPE6052. Cancel previous license/CVED usage	The system sends to EXIM a cancellation request for an already registered licenses	Intermediate
BPE6053. Handling of Goods Discharge and License/CVED usage cancellation completed	Handling of Goods Discharge and License/CVED usage cancellation completed	End

2.18.3.2 Gateway(s)

The table below defines the 'Gateway(s)' of the 'BP0841. Handle Goods discharge and License/CVED usage registration following cancellation' process.

Element Name	Description	Special Type
BPE3845. License(s) Usage already registered?	A decision point in the process to navigate the flow based on whether the usage of the licenses has been already registered or not	Decision
BPE6050. Goods Discharge already registered?	A decision point in the process to navigate the flow based on whether a Goods Discharge has been already registered	Decision